



CMV PRO EX Wentylator chemooodporny przeciwwybuchowy



Zastosowanie

Wentylator przeznaczony do transportu medium niezapalnego, zawierającego agresywne związki chemiczne. Typowe obszary zastosowania:

- dygestoria i laboratoria chemiczne
- przemysł chemiczny, farmaceutyczny, spożywczy
- obiekty użyteczności publicznej

Konstrukcja

- wirnik z łopatkami pochylonymi do tyłu wykonany z polipropylenu PPs,
- obudowa wykonana z polipropylenu PPs,
- podstawa pod silnik wykonana z blachy galwanizowanej,
- figura standardowa LG90,
- maksymalna temperatura tłoczonego medium 60°C (wykonanie standardowe) lub 70°C (wykonanie STANDARD),
- temperatura otoczenia silnika od -20°C do +40°C

Silnik elektryczny

- asynchroniczny, trójfazowy, 230/400V lub 400/690, 50 Hz (w zależności od modelu)
- stopień ochrony IP55,
- klasa izolacji F,
- przystosowany do regulacji częstotliwościowej (silniki trójfazowe) lub regulacji napięciowej (silniki jednofazowe).

Wykonania specjalne

- dowolna figura LG/RD,
- wersja STANDARD – patrz wentylatory chemooodporne,
- obudowa wykonana z: PPs-el, PE, PVC, PVDF,
- wirnik wykonany z: PPs-el, PVDF,
- napęd pasowy.

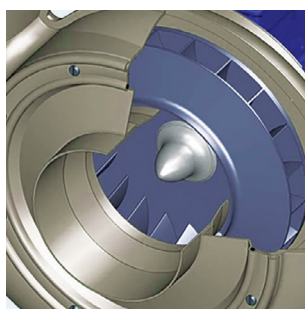

Termicznie formowana obudowa
Szeroka gama materiałów wykonania obudowy wentylatora: PPs, PPs-el, PE, PVC, PVDF.

Wirnik wyważony dynamicznie
Wirnik z łopatkami pochylonymi do przodu, formowany wtryskowo, wyważony dynamicznie zgodnie z normą ISO 1940.

Ostona przeciw odłamkowa
jako wyposażenie dodatkowe.

POWIĄZANE PRODUKTY



CMVeco
wentylator promieniowy chemooodporny



CMVeco EX
wentylator promieniowy chemooodporny w wersji ATEX



CMVpro
wentylator promieniowy chemooodporny





CMV PRO EX Wentylator chemoodporny przeciwwybuchowy

DANE TECHNICZNE

model wentylatora	wydajność maksymalna	ciśnienie maksymalne	prędkość obrotowa	napięcie nominalne	natężenie znamionowe	moc silnika	poziom ciśnienia akust.*	temperatura medium min / max	masa jednostki	numer artykułu
CMVpro-2-125-018T EX	512 m ³ /h	500 Pa	2 850 rpm	3~400 V	0,17 A	0,18 kW	51 dB(A)	-40 / 60 °C	12,0 kg	na zapytanie
CMVpro-4-125-012T EX	295 m ³ /h	145 Pa	1 420 rpm	3~400 V	0,04 A	0,12 kW	36 dB(A)	-40 / 60 °C	13,0 kg	na zapytanie
CMVpro-6-125-012T EX	195 m ³ /h	46 Pa	950 rpm	3~400 V	0,02 A	0,12 kW	28 dB(A)	-40 / 60 °C	13,0 kg	na zapytanie
CMVpro-2-160-025T EX	1 080 m ³ /h	830 Pa	2 850 rpm	3~400 V	0,45 A	0,25 kW	56 dB(A)	-40 / 60 °C	15,0 kg	na zapytanie
CMVpro-4-160-012T EX	535 m ³ /h	185 Pa	1 420 rpm	3~400 V	0,06 A	0,12 kW	41 dB(A)	-40 / 60 °C	15,0 kg	na zapytanie
CMVpro-6-160-012T EX	350 m ³ /h	65 Pa	950 rpm	3~400 V	0,03 A	0,12 kW	33 dB(A)	-40 / 60 °C	15,0 kg	na zapytanie
CMVpro-2-200-110T EX	2 740 m ³ /h	1 560 Pa	2 850 rpm	3~400 V	2,25 A	1,1 kW	62 dB(A)	-40 / 60 °C	27,0 kg	na zapytanie
CMVpro-4-200-018T EX	1 350 m ³ /h	375 Pa	1 420 rpm	3~400 V	0,30 A	0,18 kW	47 dB(A)	-40 / 60 °C	22,0 kg	na zapytanie
CMVpro-6-200-012T EX	915 m ³ /h	160 Pa	950 rpm	3~400 V	0,03 A	0,12 kW	38 dB(A)	-40 / 60 °C	22,0 kg	na zapytanie
CMVpro-2-250-300T EX	5 040 m ³ /h	2 290 Pa	2 850 rpm	3~400 V	5,88 A	3,0 kW	74 dB(A)	-40 / 60 °C	45,0 kg	na zapytanie
CMVpro-4-250-037T EX	2 510 m ³ /h	560 Pa	1 420 rpm	3~400 V	0,74 A	0,37 kW	59 dB(A)	-40 / 60 °C	30,0 kg	na zapytanie
CMVpro-6-250-012T EX	1 680 m ³ /h	245 Pa	950 rpm	3~400 V	0,23 A	0,12 kW	50 dB(A)	-40 / 60 °C	28,0 kg	na zapytanie
CMVpro-4-315-110T EX	5 930 m ³ /h	995 Pa	1 420 rpm	3~400 V	2,75 A	1,1 kW	59 dB(A)	-40 / 60 °C	61,0 kg	na zapytanie
CMVpro-6-315-037T EX	3 950 m ³ /h	440 Pa	950 rpm	3~400 V	0,63 A	0,37 kW	51 dB(A)	-40 / 60 °C	49,0 kg	na zapytanie
CMVpro-4-400-400T EX	111 20 m ³ /h	1 630 Pa	1 420 rpm	3~400 V	9,30 A	4,0 kW	62 dB(A)	-40 / 70 °C	101,0 kg	na zapytanie
CMVpro-6-400-110T EX	7 430 m ³ /h	720 Pa	950 rpm	3~400 V	2,63 A	1,1 kW	53 dB(A)	-40 / 70 °C	89,0 kg	na zapytanie

*pomiar wykonany w odległości 1,5m od wylotu, dla Q = 2/3*Qmax

CHARAKTERYSTYKI PRACY WENTYLATORÓW

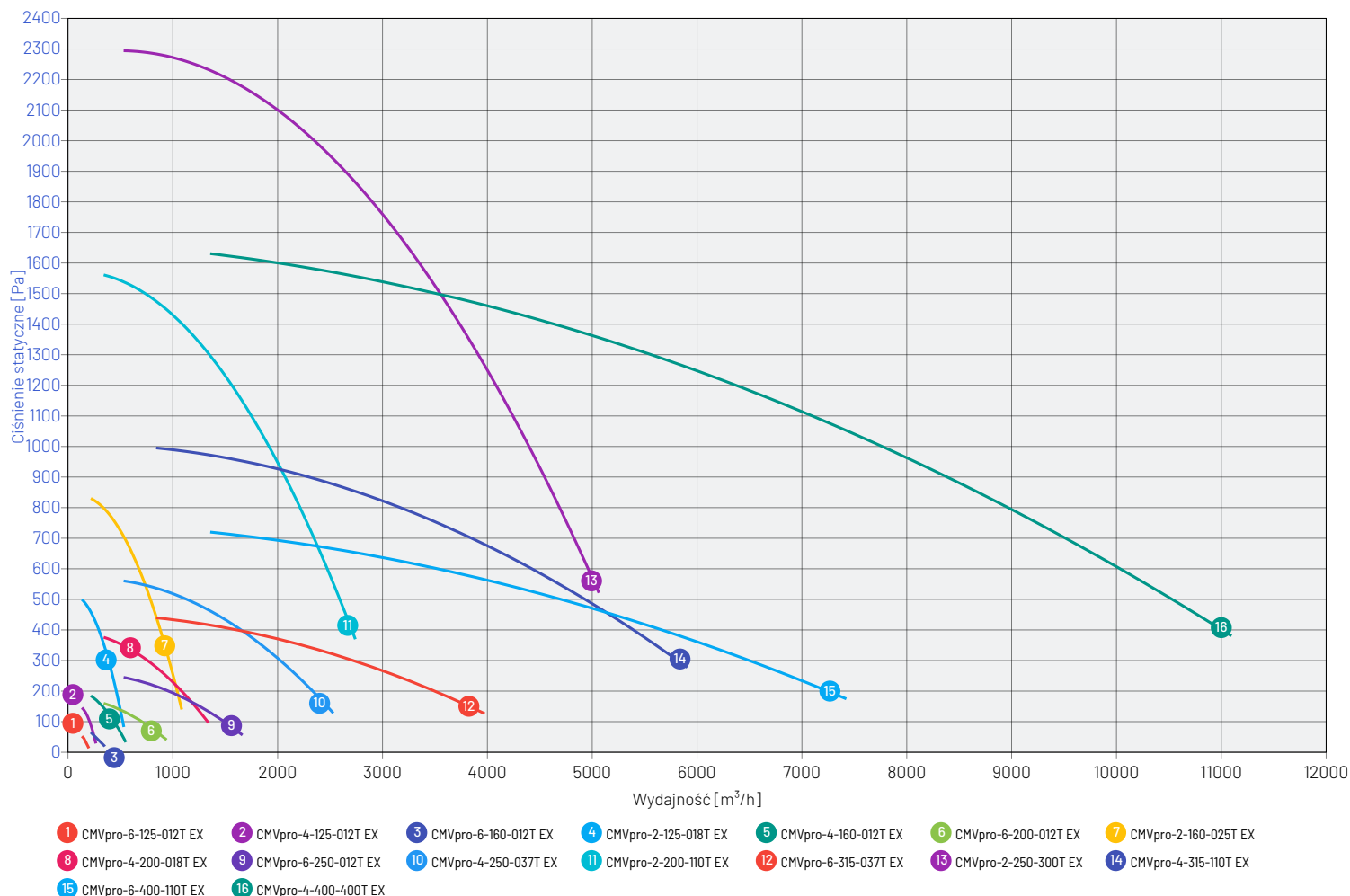



CMV PRO EX Wentylator chemoodporny przeciwybuchowy

CHARAKTERYSTYKI PRACY

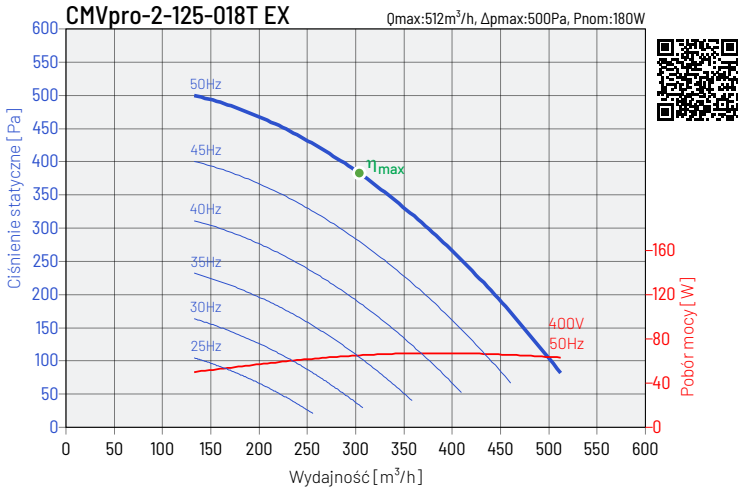

Hz / dB(A)	63	125	250	500	1000	2000	4000	8000	L_{WA}	L_{PA}
wylot	51	53	60	61	56	57	44	29	66	55
emitowany	23	32	43	51	55	56	58	43	62	51

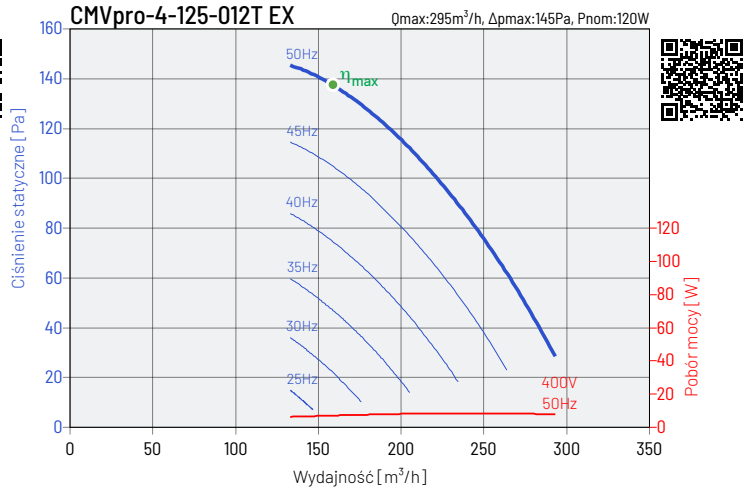

Hz / dB(A)	63	125	250	500	1000	2000	4000	8000	L_{WA}	L_{PA}
wylot	36	38	45	46	41	42	29	14	51	40
emitowany	8	17	28	36	40	41	43	28	47	36

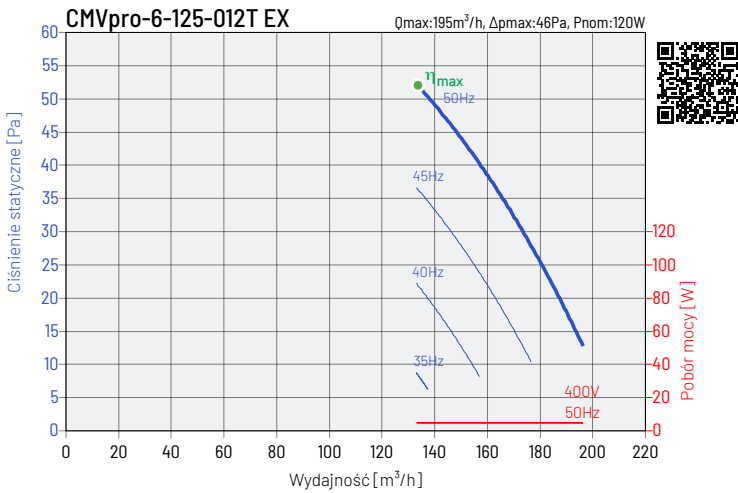

Hz / dB(A)	63	125	250	500	1000	2000	4000	8000	L_{WA}	L_{PA}
wylot	28	30	37	38	33	34	21	6	43	32
emitowany	-	9	20	28	32	33	35	20	39	28

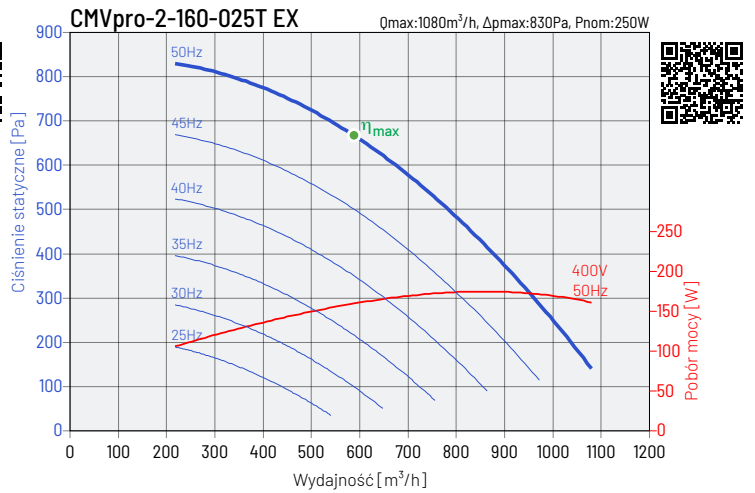

Hz / dB(A)	63	125	250	500	1000	2000	4000	8000	L_{WA}	L_{PA}
wylot	52	59	65	68	65	65	51	41	72	61
emitowany	33	32	47	53	64	62	59	48	67	56

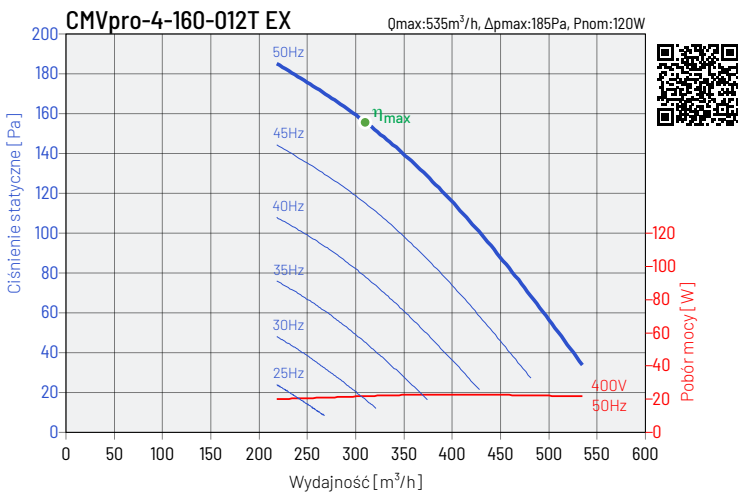

Hz / dB(A)	63	125	250	500	1000	2000	4000	8000	L_{WA}	L_{PA}
wylot	37	44	50	53	50	50	36	26	57	46
emitowany	18	17	32	38	49	47	44	33	52	41

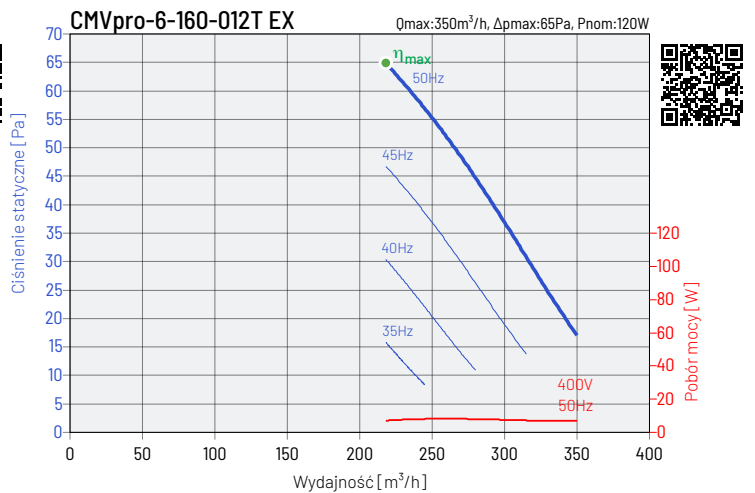

Hz / dB(A)	63	125	250	500	1000	2000	4000	8000	L_{WA}	L_{PA}
wylot	29	36	42	45	42	42	28	18	49	38
emitowany	10	9	24	30	41	39	36	25	44	33



CMV PRO EX Wentylator chemoodporny przeciwybuchowy

CHARAKTERYSTYKI PRACY

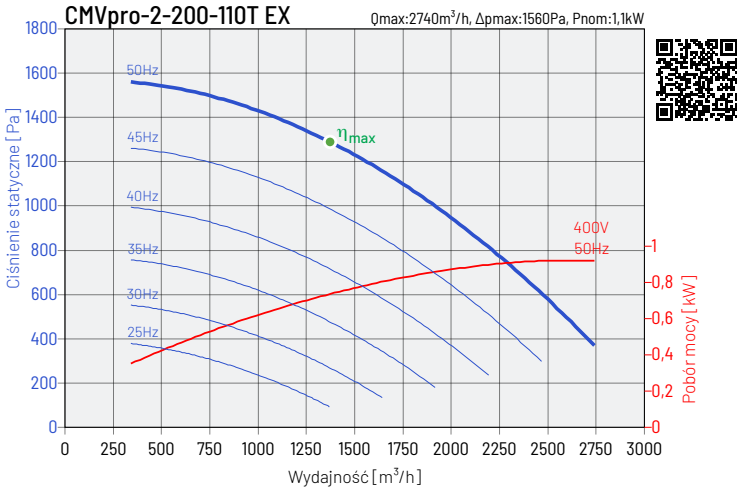

Hz / dB(A)	63	125	250	500	1000	2000	4000	8000	L_{WA}	L_{PA}
wylot	59	65	72	73	72	73	62	51	79	68
emitowany	30	45	56	65	70	68	61	51	73	62

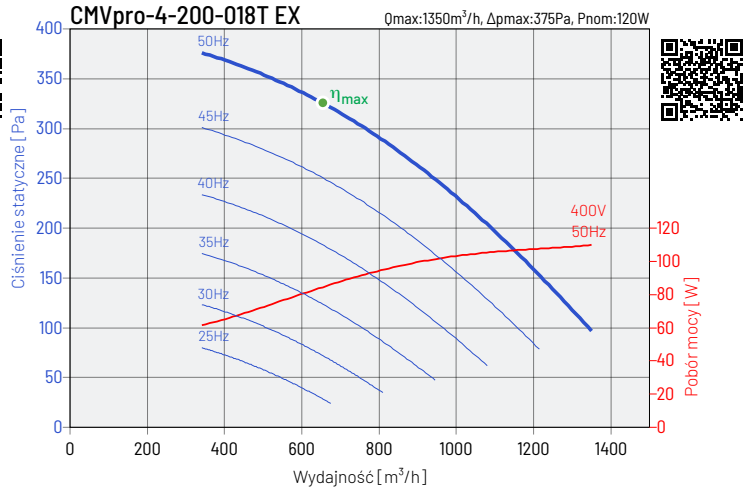

Hz / dB(A)	63	125	250	500	1000	2000	4000	8000	L_{WA}	L_{PA}
wylot	44	50	57	58	57	58	47	36	64	53
emitowany	15	30	41	50	55	53	46	36	58	47

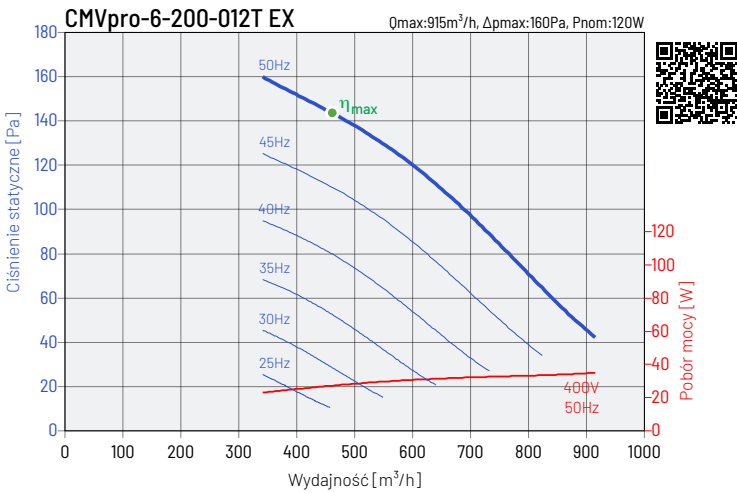

Hz / dB(A)	63	125	250	500	1000	2000	4000	8000	L_{WA}	L_{PA}
wylot	35	41	48	49	48	49	38	27	55	44
emitowany	6	21	32	41	46	44	37	27	49	38

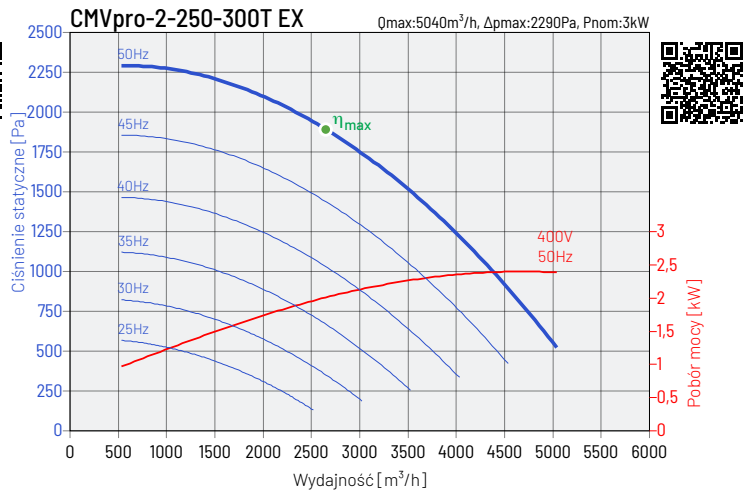

Hz / dB(A)	63	125	250	500	1000	2000	4000	8000	L_{WA}	L_{PA}
wylot	71	75	81	84	87	84	74	64	91	80
emitowany	48	60	67	75	82	79	69	57	85	74

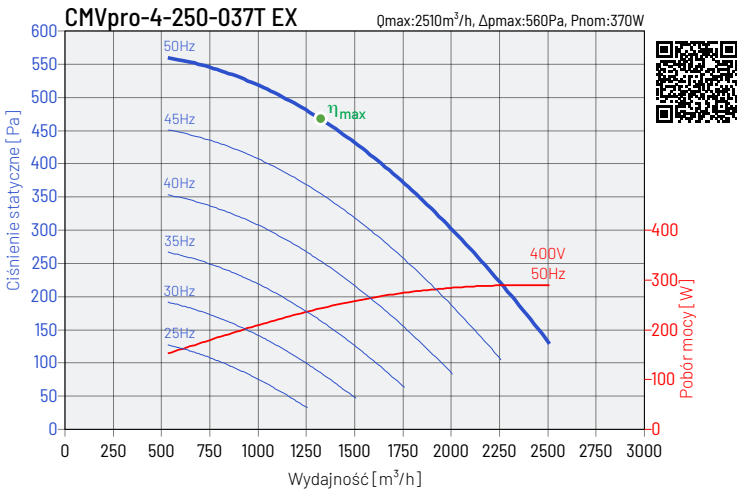

Hz / dB(A)	63	125	250	500	1000	2000	4000	8000	L_{WA}	L_{PA}
wylot	56	60	66	69	72	69	59	49	76	65
emitowany	33	45	52	60	67	64	54	42	70	59

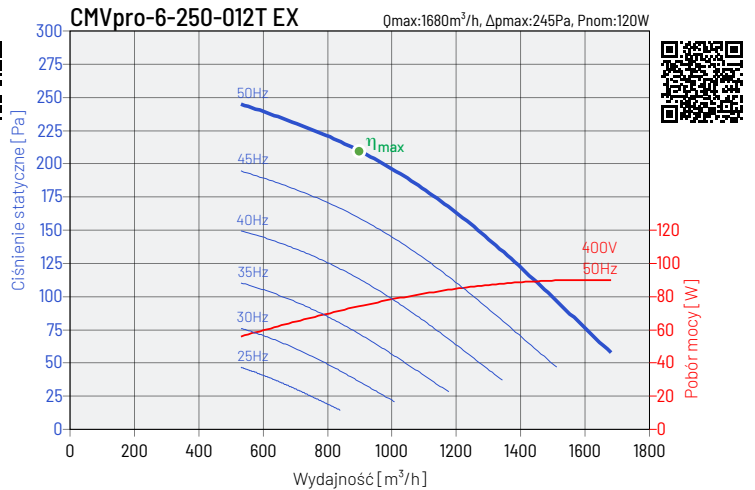

Hz / dB(A)	63	125	250	500	1000	2000	4000	8000	L_{WA}	L_{PA}
wylot	47	51	57	60	63	60	50	40	67	56
emitowany	24	36	43	51	58	55	45	33	61	50



CMV PRO EX Wentylator chemoodporny przeciwybuchowy

CHARAKTERYSTYKI PRACY

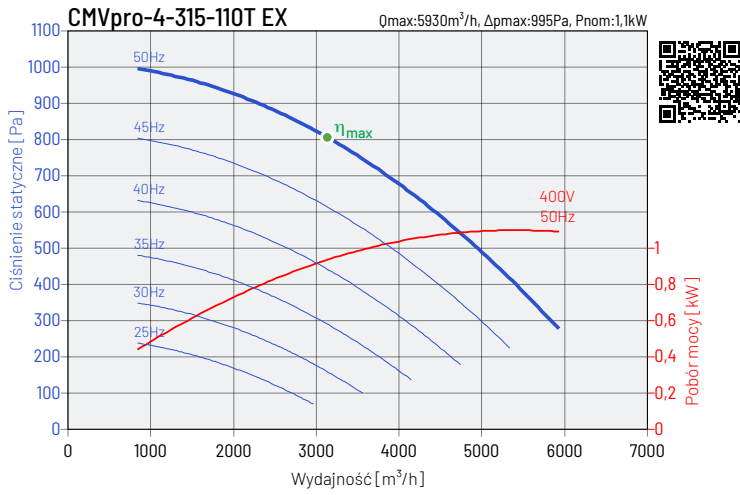

Hz / dB(A)	63	125	250	500	1000	2000	4000	8000	L_{WA}	L_{PA}
wylot	57	61	68	69	71	63	58	48	75	64
emitowany	48	51	59	62	69	58	52	48	70	59

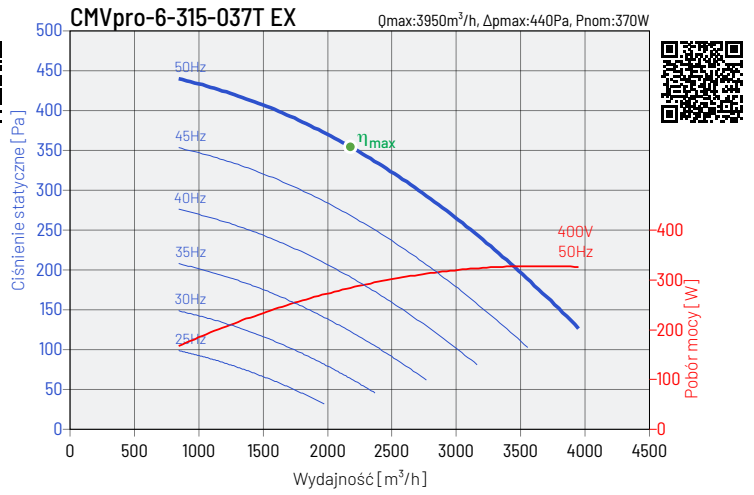

Hz / dB(A)	63	125	250	500	1000	2000	4000	8000	L_{WA}	L_{PA}
wylot	49	53	60	61	63	55	50	40	67	56
emitowany	40	43	51	54	61	50	44	40	62	51

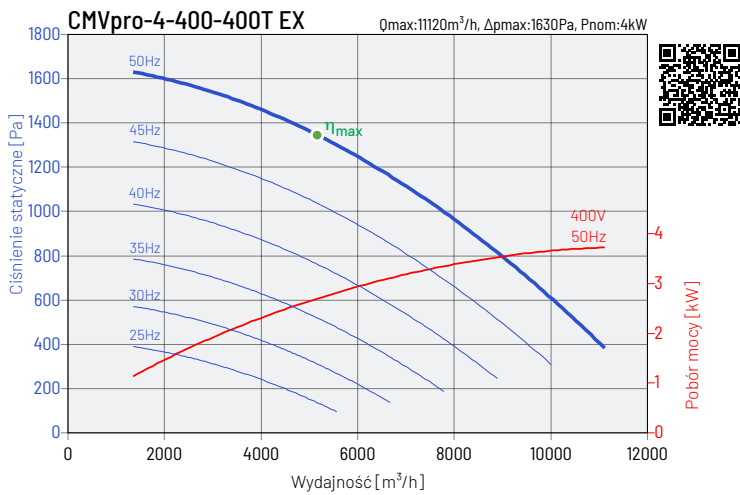

Hz / dB(A)	63	125	250	500	1000	2000	4000	8000	L_{WA}	L_{PA}
wylot	64	70	74	77	78	72	66	57	82	71
emitowany	49	53	63	69	69	63	63	55	73	62

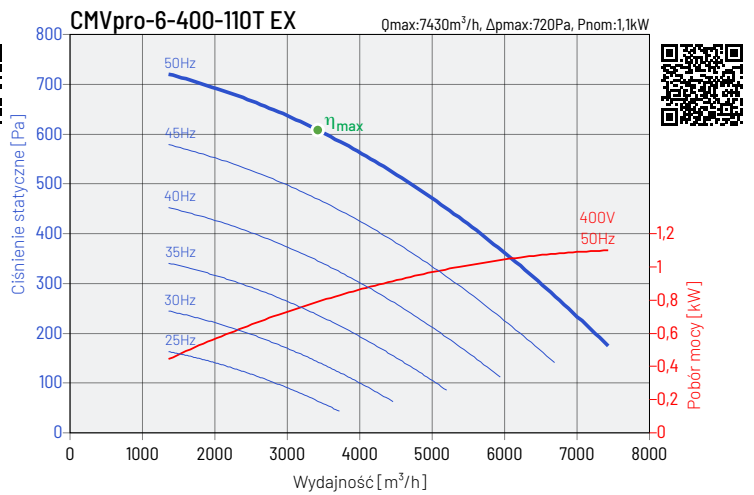

Hz / dB(A)	63	125	250	500	1000	2000	4000	8000	L_{WA}	L_{PA}
wylot	55	61	65	68	69	63	57	48	73	62
emitowany	40	44	54	60	60	54	54	46	64	53



CMV PRO EX Wentylator chemoodporny przeciwybuchowy

WYMIARY

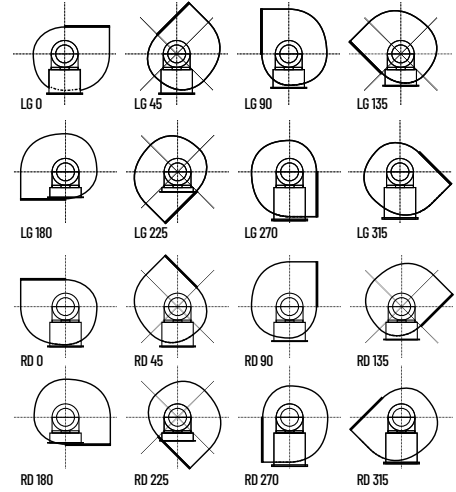
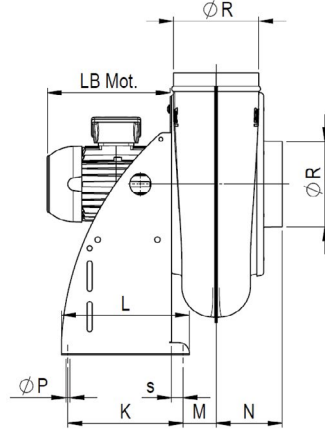
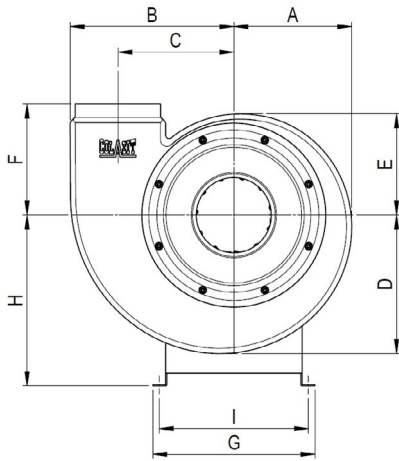

model wentylatora	A mm	B mm	C mm	D mm	E mm	F mm	G mm	H mm	I mm	K mm	L mm	M mm	N mm	ØP mm	ØR mm	s mm
CMVpro 125	179	245	170	209	154	175	270	250	240	210	240	46	110	8,4	125	20
CMVpro 160	225	310	218	264	194	216	290	330	260	230	260	59	130	8,4	160	25
CMVpro 200	277	384	272	325	238	260	380	400	350	270	300	78	155	8,4	200	27
CMVpro 250	343	477	340	403	294	320	430	500	390	290	330	104	190	10,5	250	27
CMVpro 315	429	598	428	504	367	391	480	620	440	360	400	102	225	10,5	315	62
CMVpro 400	488	646	431	561	429	460	580	700	540	410	450	139	270	10,5	400	70



CMV PRO EX

Wentylator chemoodporny przeciwybuchowy

AKCESORIA MONTAŻOWE

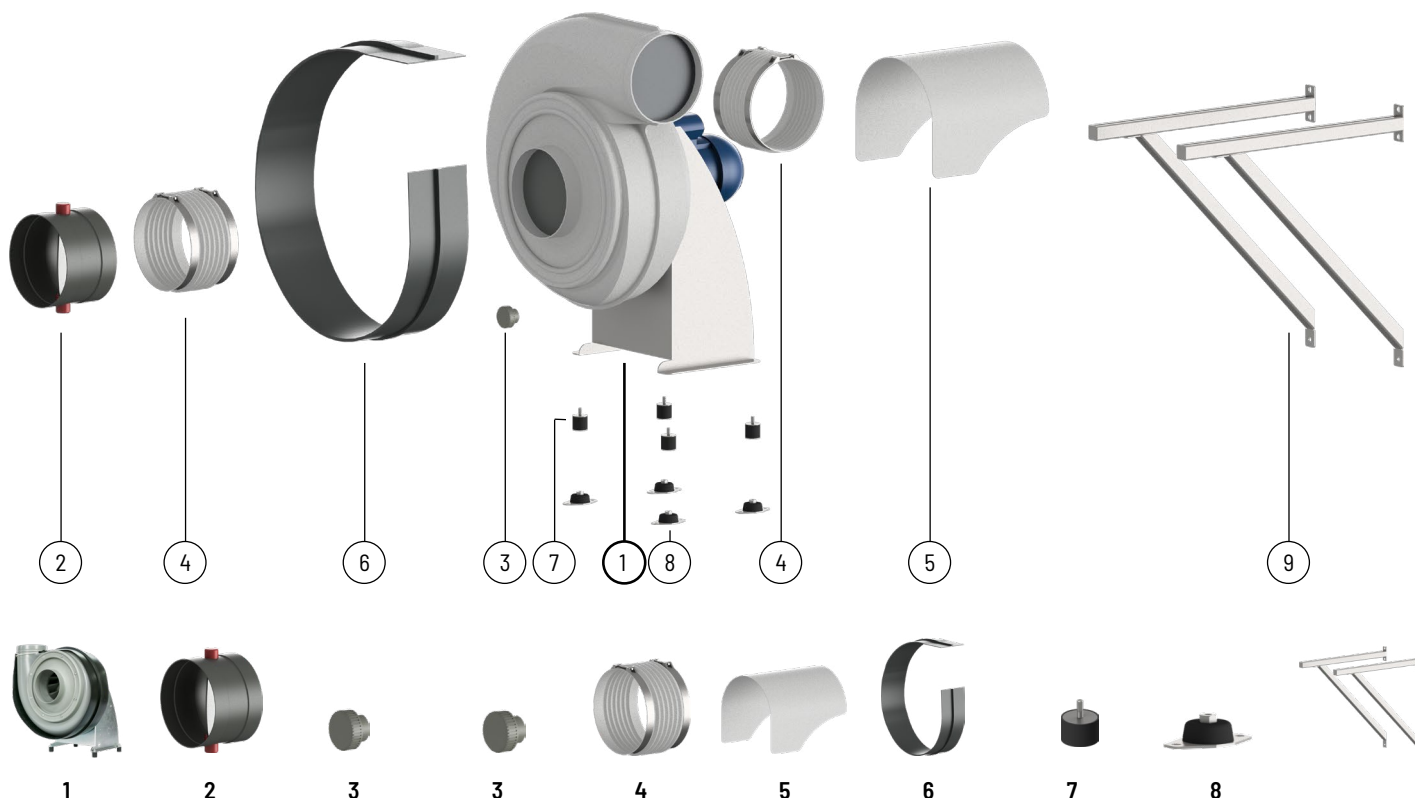

wentylator	klapa zwrotna	drenaż z zakrętką	drenaż z króćcem	złącze przeciwdrganiowe	osłona silnika	osłona przeciwołamkowa	wibroizolator	wibroizolator sufitowy	wpornik ścienny
CMVpro 125	KZ CMV 125	D-K PE D-K PP D-K PVC D-K PVDF	D-V PE D-V PP D-V PVC D-V PVDF	ZP PVC 125	OS CMV 125	OP CMV 125	WP 125-200	WS 125-200	WS CMV 125
CMVpro 160	KZ CMV 160			ZP PVC 160	OS CMV 160	OP CMV 160	WP 125-200	WS 125-200	WS CMV 160
CMVpro 200	KZ CMV 200			ZP PVC 200	OS CMV 200	OP CMV 200	WP 125-200	WS 125-200	WS CMV 200
CMVpro 250	KZ CMV 250			ZP PVC 250	OS CMV 250	OP CMV 250	WP 225-400	WS 225-400	WS CMV 250
CMVpro 315	KZ CMV 315			ZP PVC 315	OS CMV 250	OP CMV 315	WP 225-400	WS 225-400	WS CMV 315
CMVpro 400	KZ CMV 400			ZP PVC 400	OS CMV 315	OP CMV 400	WP 225-400	WS 225-400	WS CMV 400

AKCESORIA ELEKTRYCZNE



wentylator	falownik L	wyłącznik serwisowy	wentylator	falownik L	wyłącznik serwisowy	wentylator	falownik L	wyłącznik serwisowy
CMVpro-2-125-018T	L 0,4kW	RS 3F-3B SP 10A	CMVpro-6-160-012T	L 0,4kW	RS 3F-3B SP 10A	CMVpro-4-250-037T	L 0,4kW	RS 3F-3B SP 10A
CMVpro-4-125-012T	L 0,4kW	RS 3F-3B SP 10A	CMVpro-2-200-110T	L 1,5kW	RS 3F-3B SP 10A	CMVpro-6-250-012T	L 0,4kW	RS 3F-3B SP 10A
CMVpro-6-125-012T	L 0,4kW	RS 3F-3B SP 10A	CMVpro-4-200-018T	L 0,4kW	RS 3F-3B SP 10A	CMVpro-4-315-110T	L 1,5kW	RS 3F-3B SP 10A
CMVpro-2-160-025T	L 0,4kW	RS 3F-3B SP 10A	CMVpro-6-200-012T	L 0,4kW	RS 3F-3B SP 10A	CMVpro-6-315-037T	L 0,4kW	RS 3F-3B SP 10A
CMVpro-4-160-012T	L 0,4kW	RS 3F-3B SP 10A	CMVpro-2-250-300T	L 4,0kW	RS 3F-3B SP 10A	CMVpro-4-400-400T	L 4,0kW	RS 3F-3B SP 10A
						CMVpro-6-400-110T	L 1,5kW	RS 3F-3B SP 10A

Numery artykułów

44025520	KZ CMV 125	44025510	D-K PE	44025562-10	ZP PVC 125	44025581	OS CMV 125	44025751-10	WP 125-200	43527200	L 0,4kW
44025521	KZ CMV 160	44025511	D-V PE	44025563-10	ZP PVC 160	44025582	OS CMV 160	44025751-11	WP 225-400	43527210	L 1,5kW
44025522	KZ CMV 200	44025512	D-K PP	44025564-10	ZP PVC 200	44025583	OS CMV 200	44025751-20	WS 125-200	43527210	L 4,0kW
44025523	KZ CMV 250	44025513	D-V PP	44025566-10	ZP PVC 250	44025584	OS CMV 250	44025751-21	WS 225-400	91040908-01	RS 3F-3B SP 11.5 0A
44025524	KZ CMV 315	44025514	D-K PVC	44025567-10	ZP PVC 315	44025584	OS CMV 315				
44025525	KZ CMV 400	44025515	D-V PVC	44025568-10	ZP PVC 400	44025585	OS CMV 400				
		44025516	D-K PVDF								
		44025517	D-V PVDF								