

Anwendung

Abluft-Dachventilatoren REX-V erfüllen die Anforderungen der Richtlinie ATEX 2014/34EU, sind für den Einsatz konzipiert in explosionsgefährdeten Bereichen außerhalb von Bergwerken und Bergbauausgrabungen, erfüllen die Anforderungen der Gruppe II, Kategorie 2G/3G – Zone 1 oder 2 und der Kategorie 2D/3D – Zone 21 und/oder 22.

ATEX-Kennzeichnung:
II 2G Ex h IIB+H2 T3 Gb
II 2G Ex h IIB+H2 T4 Gb
II 2D Ex h IIIC T125°C Db

Konstruktion

- Mitteldruck-Radialventilator mit Direktantrieb,
- Laufrad aus Aluminiumblech mit nach hinten geneigten Schaufeln, dynamisch ausgewuchtet nach ISO 1940-1,
- Gehäuseelemente aus Rohaluminium und Edelstahl,
- maximaler Temperaturbereich des Fördermediums von -20°C bis +60°C,
- Mindestumgebungstemperatur -20°C,
- Geeignet für die Montage eines Vibrationssensors.

Elektrischer Motor

- explosionsgeschützt, asynchron, einphasig 230V 50Hz,
- explosionsgeschützt, asynchron, dreiphasig 230/400V 50Hz oder 400/690V 50Hz (abhängig von der Motorleistung),
- Isolationsklasse F,
- PTC-Wärmeschutz,
- VFD-Version angepasst an die Frequenzregelung.

Sonderausführung

- lackiertes Gehäuse,
- Motor für andere als die Standardspannung und Netzfrequenz,
- Motor mit unterschiedlichem IP-Schutzgrad,
- Laufrad und Gehäuse aus Edelstahl,
- Umgebungstemperatur bis +60°C.

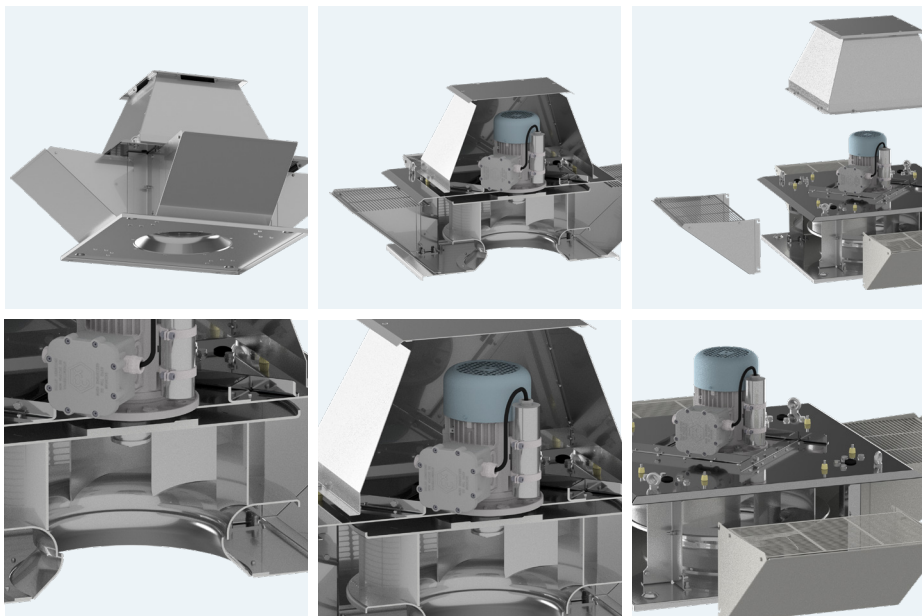
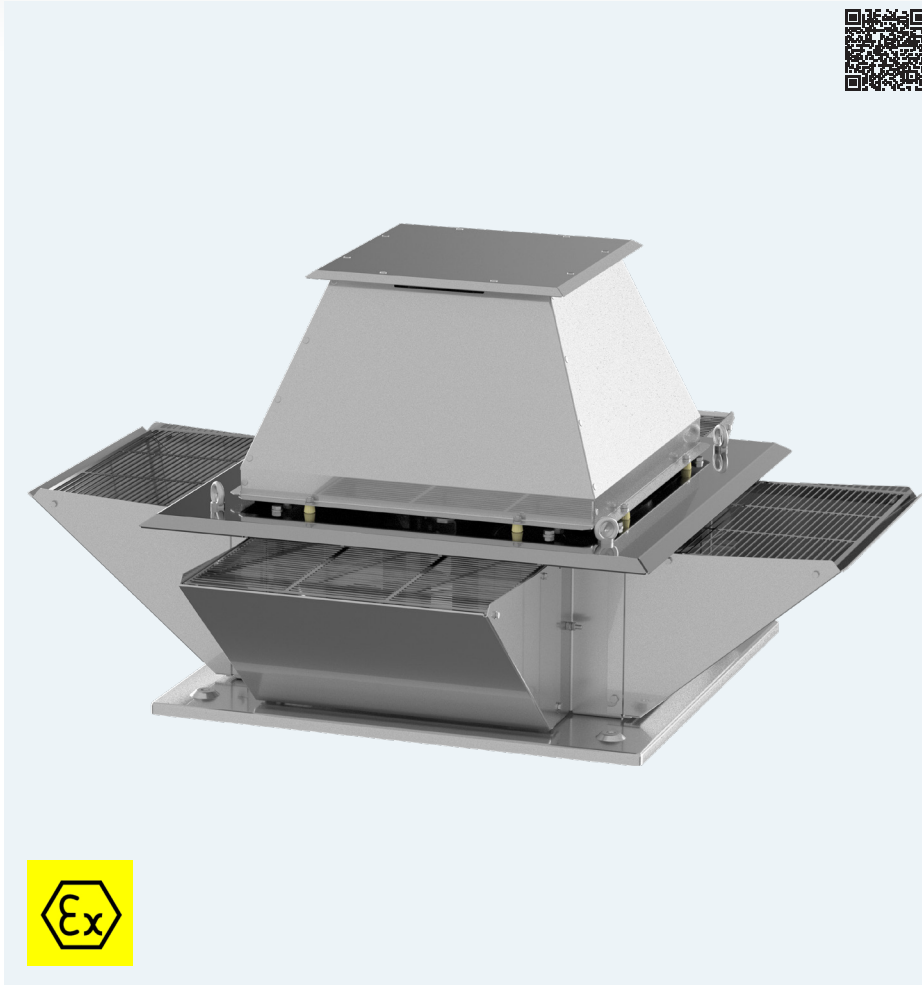

VERWANDTE PRODUKTE



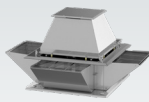

NENNDATEN

Typ	Volumenstrom max	Druck max	Motor Drehzahl	Nennspannung	Nennstrom**	Motorleistung	Schalldruckpegel Fall*	Temp.-betrieb min / max	Temp.-umgebungs min / max	Gewicht	Artikelnummer
2-POLIGE MOTOREN 3000RPM											
REX-V/2-190-012T 2G	730 m³/h	340 Pa	2 750 rpm	400 V	0,4 A	120 W	67 dB(A)	-20 / 40 °C	-20 / 40	12,5 kg	45526200
REX-V/2-190-012T 2G VFD	730 m³/h	340 Pa	2 800 rpm	400 V	0,48 A	120 W	67 dB(A)	-20 / 50 °C	-20 / 50	14,5 kg	425526201
REX-V/2-190-012T 2GD VFD	730 m³/h	340 Pa	2 800 rpm	400 V	0,48 A	120 W	67 dB(A)	-20 / 50 °C	-20 / 50	14,5 kg	425526202
REX-V/2-190-012S 2G	730 m³/h	340 Pa	2 880 rpm	230 V	1,3 A	120 W	67 dB(A)	-20 / 50 °C	-20 / 50	15,5 kg	45526203
REX-V/2-190-012S 2GD	730 m³/h	340 Pa	2 880 rpm	230 V	1,3 A	120 W	67 dB(A)	-20 / 50 °C	-20 / 50	15,5 kg	45526204
REX-V/2-220-012T 2G	1020 m³/h	435 Pa	2 750 rpm	400 V	0,4 A	120 W	68 dB(A)	-20 / 40 °C	-20 / 40	12,5 kg	45526210
REX-V/2-220-012T 2G VFD	1020 m³/h	435 Pa	2 800 rpm	400 V	0,48 A	120 W	68 dB(A)	-20 / 50 °C	-20 / 50	14,5 kg	425526211
REX-V/2-220-012T 2GD VFD	1020 m³/h	435 Pa	2 800 rpm	400 V	0,48 A	120 W	68 dB(A)	-20 / 50 °C	-20 / 50	14,5 kg	425526212
REX-V/2-220-012S 2G	1020 m³/h	435 Pa	2 880 rpm	230 V	1,3 A	120 W	68 dB(A)	-20 / 50 °C	-20 / 50	15,5 kg	45526213
REX-V/2-220-012S 2GD	1020 m³/h	435 Pa	2 880 rpm	230 V	1,3 A	120 W	68 dB(A)	-20 / 50 °C	-20 / 50	15,5 kg	45526214
REX-V/2-280(250)-025T 2G	1745 m³/h	630 Pa	2 870 rpm	400 V	0,9 A	250 W	71 dB(A)	-20 / 40 °C	-20 / 40	16,0 kg	45526220
REX-V/2-280(250)-025T 2G VFD	1745 m³/h	630 Pa	2 830 rpm	400 V	0,81 A	250 W	71 dB(A)	-20 / 50 °C	-20 / 50	18,0 kg	425526221
REX-V/2-280(250)-025T 2GD VFD	1745 m³/h	630 Pa	2 830 rpm	400 V	0,81 A	250 W	71 dB(A)	-20 / 50 °C	-20 / 50	18,0 kg	425526222
REX-V/2-280(250)-025S 2G	1745 m³/h	630 Pa	2 800 rpm	230 V	1,81 A	250 W	71 dB(A)	-20 / 50 °C	-20 / 50	18,0 kg	45526223
REX-V/2-280(250)-025S 2GD	1745 m³/h	630 Pa	2 800 rpm	230 V	1,81 A	250 W	71 dB(A)	-20 / 50 °C	-20 / 50	18,0 kg	45526224
4-POLIGE MOTOREN 1500RPM											
REX-V/4-190-006T 2G	360 m³/h	80 Pa	1 380 rpm	400 V	0,31 A	60 W	52 dB(A)	-20 / 60 °C	-20 / 40	12,5 kg	45526400
REX-V/4-190-012T 2G VFD	360 m³/h	80 Pa	1 390 rpm	400 V	0,49 A	120 W	52 dB(A)	-20 / 60 °C	-20 / 50	15,0 kg	425526401
REX-V/4-190-012T 2GD VFD	360 m³/h	80 Pa	1 390 rpm	400 V	0,49 A	120 W	52 dB(A)	-20 / 60 °C	-20 / 50	15,0 kg	425526402
REX-V/4-190-009S 2G	360 m³/h	80 Pa	1 420 rpm	230 V	0,8 A	90 W	52 dB(A)	-20 / 60 °C	-20 / 50	15,5 kg	45526403
REX-V/4-190-009S 2GD	360 m³/h	80 Pa	1 420 rpm	230 V	0,8 A	90 W	52 dB(A)	-20 / 60 °C	-20 / 50	15,5 kg	45526404
REX-V/4-220-006T 2G	500 m³/h	105 Pa	1 380 rpm	400 V	0,31 A	60 W	53 dB(A)	-20 / 60 °C	-20 / 40	12,5 kg	45526410
REX-V/4-220-012T 2G VFD	500 m³/h	105 Pa	1 390 rpm	400 V	0,49 A	120 W	53 dB(A)	-20 / 60 °C	-20 / 50	15,0 kg	425526411
REX-V/4-220-012T 2GD VFD	500 m³/h	105 Pa	1 390 rpm	400 V	0,49 A	120 W	53 dB(A)	-20 / 60 °C	-20 / 50	15,0 kg	425526412
REX-V/4-220-009S 2G	500 m³/h	105 Pa	1 420 rpm	230 V	0,8 A	90 W	53 dB(A)	-20 / 60 °C	-20 / 50	15,5 kg	45526413
REX-V/4-220-009S 2GD	500 m³/h	105 Pa	1 420 rpm	230 V	0,8 A	90 W	53 dB(A)	-20 / 60 °C	-20 / 50	15,5 kg	45526414
REX-V/4-250-018T 2G	1100 m³/h	180 Pa	1 390 rpm	400 V	0,7 A	180 W	53 dB(A)	-20 / 60 °C	-20 / 40	16,5 kg	45526420
REX-V/4-250-018T 2G VFD	1100 m³/h	180 Pa	1 340 rpm	400 V	0,57 A	180 W	53 dB(A)	-20 / 60 °C	-20 / 50	17,5 kg	425526421
REX-V/4-250-018T 2GD VFD	1100 m³/h	180 Pa	1 340 rpm	400 V	0,57 A	180 W	53 dB(A)	-20 / 60 °C	-20 / 50	17,5 kg	425526422
REX-V/4-250-018S 2G	1100 m³/h	180 Pa	1 355 rpm	230 V	1,38 A	180 W	53 dB(A)	-20 / 60 °C	-20 / 50	18,5 kg	45526423
REX-V/4-250-018S 2GD	1100 m³/h	180 Pa	1 355 rpm	230 V	1,38 A	180 W	53 dB(A)	-20 / 60 °C	-20 / 50	18,5 kg	45526424
REX-V/4-280-025T 2G	1570 m³/h	230 Pa	1 370 rpm	400 V	0,85 A	250 W	56 dB(A)	-20 / 60 °C	-20 / 40	18,0 kg	45526430
REX-V/4-280-025T 2G VFD	1570 m³/h	230 Pa	1 430 rpm	400 V	0,79 A	250 W	56 dB(A)	-20 / 60 °C	-20 / 50	20,0 kg	425526431
REX-V/4-280-025T 2GD VFD	1570 m³/h	230 Pa	1 430 rpm	400 V	0,79 A	250 W	56 dB(A)	-20 / 60 °C	-20 / 50	20,0 kg	425526432
REX-V/4-280-025S 2G	1570 m³/h	230 Pa	1 450 rpm	230 V	2 A	250 W	56 dB(A)	-20 / 60 °C	-20 / 50	21,0 kg	45526433
REX-V/4-280-025S 2GD	1570 m³/h	230 Pa	1 450 rpm	230 V	2 A	250 W	56 dB(A)	-20 / 60 °C	-20 / 50	21,0 kg	45526434
REX-V/4-315-037T 2G	2 210 m³/h	290 Pa	1 350 rpm	400 V	1,15 A	370 W	59 dB(A)	-20 / 60 °C	-20 / 40	25,5 kg	45526440
REX-V/4-315-037T 2G VFD	2 210 m³/h	290 Pa	1 420 rpm	400 V	1,08 A	370 W	59 dB(A)	-20 / 60 °C	-20 / 50	26,6 kg	425526441
REX-V/4-315-037T 2GD VFD	2 210 m³/h	290 Pa	1 420 rpm	400 V	1,08 A	370 W	59 dB(A)	-20 / 60 °C	-20 / 50	25,5 kg	425526442
REX-V/4-315-037S 2G	2 210 m³/h	290 Pa	1 430 rpm	230 V	2,55 A	370 W	59 dB(A)	-20 / 60 °C	-20 / 50	28,0 kg	45526443
REX-V/4-315-037S 2GD	2 210 m³/h	290 Pa	1 430 rpm	230 V	2,55 A	370 W	59 dB(A)	-20 / 60 °C	-20 / 50	28,0 kg	45526444
REX-V/4-355-055T 2G	3 130 m³/h	375 Pa	1 360 rpm	400 V	1,5 A	550 W	62 dB(A)	-20 / 60 °C	-20 / 40	32,5 kg	45526450
REX-V/4-355-055T 2G VFD	3 130 m³/h	375 Pa	1 440 rpm	400 V	1,32 A	550 W	62 dB(A)	-20 / 60 °C	-20 / 50	35,0 kg	425526451

* Messung in 1,5 m Entfernung vom Auslass, für Q = 2/3 * Qmax

** Der Nennstrom ist abhängig von eingesetztem Motorfabrikat.

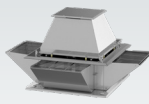

NENNDATEN

Typ	Volumenstrom max	Druck max	Motor Drehzahl	Nennspannung	Nennstrom**	Motorleistung	Schalldruckpegel Fall*	Temp.-betrieb min / max	Temp.-umgebungs min / max	Gewicht	Artikelnummer
REX-V/4-355-055T 2GD VFD	3 130 m³/h	375 Pa	1 440 rpm	400 V	1,32 A	550 W	62 dB(A)	-20 / 60 °C	-20 / 50	35,0 kg	425526452
REX-V/4-355-055S 2G	3 130 m³/h	375 Pa	1 440 rpm	230 V	3,7 A	550 W	62 dB(A)	-20 / 60 °C	-20 / 50	35,0 kg	45526453
REX-V/4-355-055S 2GD	3 130 m³/h	375 Pa	1 440 rpm	230 V	3,7 A	550 W	62 dB(A)	-20 / 60 °C	-20 / 50	35,0 kg	45526454
REX-V/4-400-075T 2G	4 600 m³/h	475 Pa	1 360 rpm	400 V	1,9 A	750 W	65 dB(A)	-20 / 60 °C	-20 / 40	41,0 kg	45526460
REX-V/4-400-075T 2G VFD	4 600 m³/h	475 Pa	1 445 rpm	400 V	1,85 A	750 W	65 dB(A)	-20 / 60 °C	-20 / 50	45,0 kg	435526461
REX-V/4-400-075T 2GD VFD	4 600 m³/h	475 Pa	1 445 rpm	400 V	1,85 A	750 W	65 dB(A)	-20 / 60 °C	-20 / 50	45,0 kg	435526462
REX-V/4-400-075S 2G	4 600 m³/h	475 Pa	1 410 rpm	230 V	4,74 A	750 W	65 dB(A)	-20 / 60 °C	-20 / 50	44,0 kg	45526463
REX-V/4-400-075S 2GD	4 600 m³/h	475 Pa	1 410 rpm	230 V	4,74 A	750 W	65 dB(A)	-20 / 60 °C	-20 / 50	44,0 kg	45526464
REX-V/4-450-110T 2G	6 540 m³/h	620 Pa	1 405 rpm	400 V	2,7 A	1100 W	68 dB(A)	-20 / 60 °C	-20 / 40	53,5 kg	45526470
REX-V/4-450-110T 2G VFD	6 540 m³/h	620 Pa	1 440 rpm	400 V	2,61 A	1100 W	68 dB(A)	-20 / 60 °C	-20 / 50	56,5 kg	435526471
REX-V/4-450-110T 2GD VFD	6 540 m³/h	620 Pa	1 440 rpm	400 V	2,61 A	1100 W	68 dB(A)	-20 / 60 °C	-20 / 50	56,5 kg	435526472
REX-V/4-450-110S 2G	6 540 m³/h	620 Pa	1 440 rpm	230 V	7,6 A	1100 W	68 dB(A)	-20 / 60 °C	-20 / 50	55,5 kg	45526473
REX-V/4-450-110S 2GD	6 540 m³/h	620 Pa	1 440 rpm	230 V	7,6 A	1100 W	68 dB(A)	-20 / 60 °C	-20 / 50	55,5 kg	45526474
REX-V/4-500-220T 2G	8 940 m³/h	740 Pa	1 425 rpm	400 V	5,2 A	2200 W	71 dB(A)	-20 / 60 °C	-20 / 40	70,5 kg	45526480
REX-V/4-500-220T 2G VFD	8 940 m³/h	740 Pa	1 440 rpm	400 V	4,9 A	2200 W	71 dB(A)	-20 / 60 °C	-20 / 50	74,5 kg	435526481
REX-V/4-500-220T 2GD VFD	8 940 m³/h	740 Pa	1 440 rpm	400 V	4,9 A	2200 W	71 dB(A)	-20 / 60 °C	-20 / 50	74,5 kg	435526482
REX-V/4-560-300T 2G	12 530 m³/h	920 Pa	1 415 rpm	400 V	6,9 A	3000 W	75 dB(A)	-20 / 60 °C	-20 / 40	81,0 kg	45526490
REX-V/4-560-300T 2G VFD	12 530 m³/h	920 Pa	1 455 rpm	400 V	6,05 A	3000 W	75 dB(A)	-20 / 60 °C	-20 / 50	91,0 kg	435526491
REX-V/4-560-300T 2GD VFD	12 530 m³/h	920 Pa	1 455 rpm	400 V	6,05 A	3000 W	75 dB(A)	-20 / 60 °C	-20 / 50	91,0 kg	435526492
6-POLIGE MOTOREN 1000RPM											
REX-V/6-250-018T 2G	725 m³/h	75 Pa	880 rpm	400 V	0,7 A	180 W	50 dB(A)	-20 / 60 °C	-20 / 40	17,0 kg	45526620
REX-V/6-250-012T 2G VFD	725 m³/h	75 Pa	935 rpm	400 V	0,59 A	120 W	50 dB(A)	-20 / 60 °C	-20 / 50	18,5 kg	425526621
REX-V/6-250-012T 2GD VFD	725 m³/h	75 Pa	935 rpm	400 V	0,59 A	120 W	50 dB(A)	-20 / 60 °C	-20 / 50	18,5 kg	425526622
REX-V/6-280-018T 2G	1 025 m³/h	100 Pa	880 rpm	400 V	0,7 A	180 W	53 dB(A)	-20 / 60 °C	-20 / 40	18,0 kg	45526630
REX-V/6-280-012T 2G VFD	1 025 m³/h	100 Pa	935 rpm	400 V	0,59 A	120 W	53 dB(A)	-20 / 60 °C	-20 / 50	19,0 kg	425526631
REX-V/6-280-012T 2GD VFD	1 025 m³/h	100 Pa	935 rpm	400 V	0,59 A	120 W	53 dB(A)	-20 / 60 °C	-20 / 50	19,0 kg	425526632
REX-V/6-315-018T 2G	1 450 m³/h	125 Pa	880 rpm	400 V	0,7 A	180 W	56 dB(A)	-20 / 60 °C	-20 / 40	24,5 kg	45526640
REX-V/6-315-012T 2G VFD	1 450 m³/h	125 Pa	935 rpm	400 V	0,59 A	120 W	56 dB(A)	-20 / 60 °C	-20 / 50	25,5 kg	425526641
REX-V/6-315-012T 2GD VFD	1 450 m³/h	125 Pa	935 rpm	400 V	0,59 A	120 W	56 dB(A)	-20 / 60 °C	-20 / 50	25,5 kg	425526642
REX-V/6-355-018T 2G	2 050 m³/h	160 Pa	880 rpm	400 V	0,7 A	180 W	59 dB(A)	-20 / 60 °C	-20 / 40	30,0 kg	45526650
REX-V/6-355-018T 2G VFD	2 050 m³/h	160 Pa	925 rpm	400 V	0,82 A	180 W	59 dB(A)	-20 / 60 °C	-20 / 50	32,0 kg	425526651
REX-V/6-355-018T 2GD VFD	2 050 m³/h	160 Pa	925 rpm	400 V	0,82 A	180 W	59 dB(A)	-20 / 60 °C	-20 / 50	32,0 kg	425526652
REX-V/6-400-025T 2G	3 020 m³/h	205 Pa	900 rpm	400 V	0,85 A	250 W	62 dB(A)	-20 / 60 °C	-20 / 40	38,0 kg	45526660
REX-V/6-400-025T 2G VFD	3 020 m³/h	205 Pa	930 rpm	400 V	0,88 A	250 W	62 dB(A)	-20 / 60 °C	-20 / 50	40,0 kg	425526661
REX-V/6-400-025T 2GD VFD	3 020 m³/h	205 Pa	930 rpm	400 V	0,88 A	250 W	62 dB(A)	-20 / 60 °C	-20 / 50	40,0 kg	425526662
REX-V/6-450-037T 2G	4 290 m³/h	270 Pa	920 rpm	400 V	1,3 A	370 W	65 dB(A)	-20 / 60 °C	-20 / 40	48,5 kg	45526670
REX-V/6-450-037T 2G VFD	4 290 m³/h	270 Pa	945 rpm	400 V	1,05 A	370 W	65 dB(A)	-20 / 60 °C	-20 / 50	51,5 kg	425526671
REX-V/6-450-037T 2GD VFD	4 290 m³/h	270 Pa	945 rpm	400 V	1,05 A	370 W	65 dB(A)	-20 / 60 °C	-20 / 50	51,5 kg	425526672
REX-V/6-500-075T 2G	5 860 m³/h	320 Pa	915 rpm	400 V	2,1 A	750 W	68 dB(A)	-20 / 60 °C	-20 / 40	66,0 kg	45526680
REX-V/6-500-075T 2G VFD	5 860 m³/h	320 Pa	945 rpm	400 V	1,96 A	750 W	68 dB(A)	-20 / 60 °C	-20 / 50	66,0 kg	435526681
REX-V/6-500-075T 2GD VFD	5 860 m³/h	320 Pa	945 rpm	400 V	1,96 A	750 W	68 dB(A)	-20 / 60 °C	-20 / 50	66,0 kg	435526682
REX-V/6-560-110T 2G	8 210 m³/h	400 Pa	920 rpm	400 V	3 A	1100 W	72 dB(A)	-20 / 60 °C	-20 / 40	73,0 kg	45526690
REX-V/6-560-110T 2G VFD	8 210 m³/h	400 Pa	950 rpm	400 V	2,7 A	1100 W	72 dB(A)	-20 / 60 °C	-20 / 50	79,0 kg	435526691
REX-V/6-560-110T 2GD VFD	8 210 m³/h	400 Pa	950 rpm	400 V	2,7 A	1100 W	72 dB(A)	-20 / 60 °C	-20 / 50	79,0 kg	435526692
REX-V/6-630-220T 2G	11 890 m³/h	520 Pa	960 rpm	400 V	5,1 A	2200 W	76 dB(A)	-20 / 60 °C	-20 / 40	122,0 kg	45526700

* Messung in 1,5 m Entfernung vom Auslass, für Q = 2/3 * Qmax
 ** Der Nennstrom ist abhängig von eingesetztem Motorfabrikat.

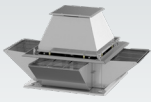

NENNDATEN

Typ	Volumenstrom max	Druck max	Motor Drehzahl	Nennspannung	Nennstrom**	Motorleistung	Schalldruckpegel Fall*	Temp.-betrieb min / max	Temp.-umgebungs min / max	Gewicht	Artikelnummer
REX-V/6-630-220T 2G VFD	11 890 m³/h	520 Pa	955 rpm	400 V	5,2 A	2200 W	76 dB(A)	-20 / 60 °C	-20 / 50	133,0 kg	435526701
REX-V/6-630-220T 2GD VFD	11 890 m³/h	520 Pa	955 rpm	400 V	5,2 A	2200 W	76 dB(A)	-20 / 60 °C	-20 / 50	133,0 kg	435526702
REX-V/6-710-300T 2G	16 960 m³/h	660 Pa	950 rpm	400 V	6,8 A	3000 W	80 dB(A)	-20 / 60 °C	-20 / 40	165,0 kg	45526710
REX-V/6-710-300T 2G VFD	16 960 m³/h	660 Pa	965 rpm	400 V	6,32 A	3000 W	80 dB(A)	-20 / 60 °C	-20 / 50	160,0 kg	435526711
REX-V/6-710-300T 2GD VFD	16 960 m³/h	660 Pa	965 rpm	400 V	6,32 A	3000 W	80 dB(A)	-20 / 60 °C	-20 / 50	160,0 kg	435526712
REX-V/6-800-550T 2G	25 220 m³/h	875 Pa	950 rpm	400 V	11,6 A	5500 W	84 dB(A)	-20 / 60 °C	-20 / 40	228,0 kg	45526720
REX-V/6-800-550T 2G VFD	25 220 m³/h	875 Pa	970 rpm	400 V	11,4 A	5500 W	84 dB(A)	-20 / 60 °C	-20 / 50	260,0 kg	435526721
REX-V/6-800-550T 2GD VFD	25 220 m³/h	875 Pa	970 rpm	400 V	11,4 A	5500 W	84 dB(A)	-20 / 60 °C	-20 / 50	260,0 kg	435526722

* Messung in 1,5 m Entfernung vom Auslass, für $Q = 2/3 \cdot Q_{max}$

** Der Nennstrom ist abhängig von eingesetztem Motorfabrikat.

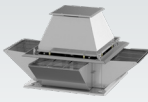

LEISTUNGSMERKMALE DER VENTILATOREN - 2-POLIGE MOTOREN 3000RPM

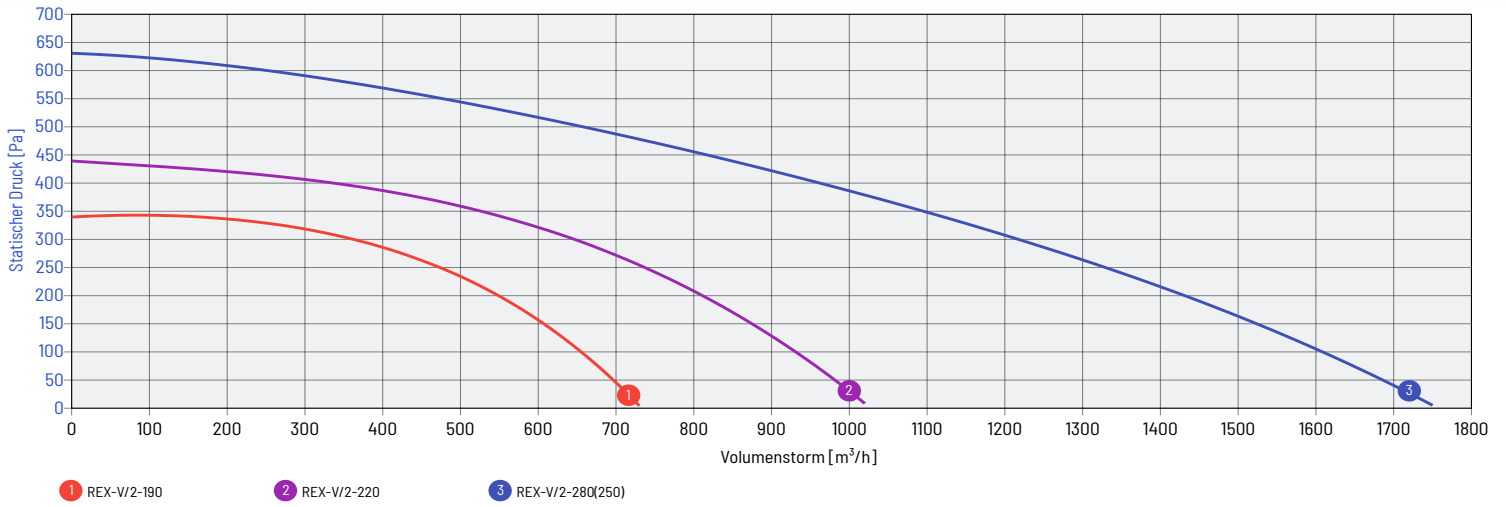

LEISTUNGSMERKMALE DER VENTILATOREN - 4-POLIGE MOTOREN 1500RPM

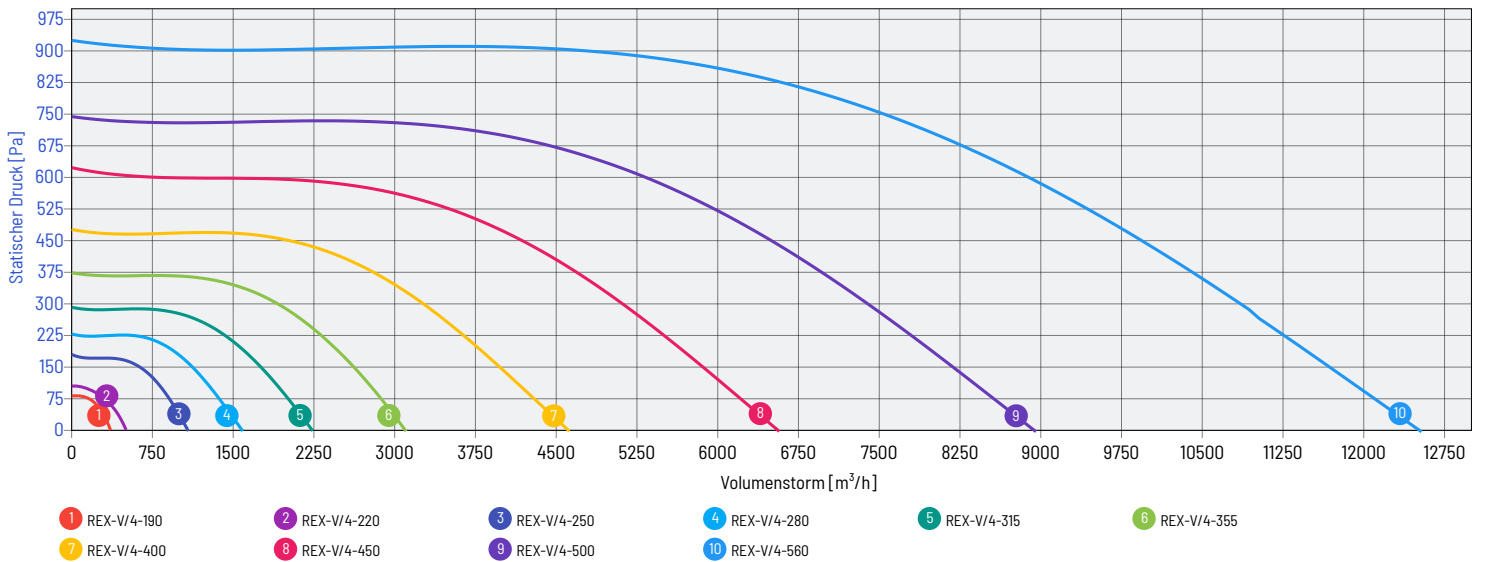

LEISTUNGSMERKMALE DER VENTILATOREN - 6-POLIGE MOTOREN 1000RPM

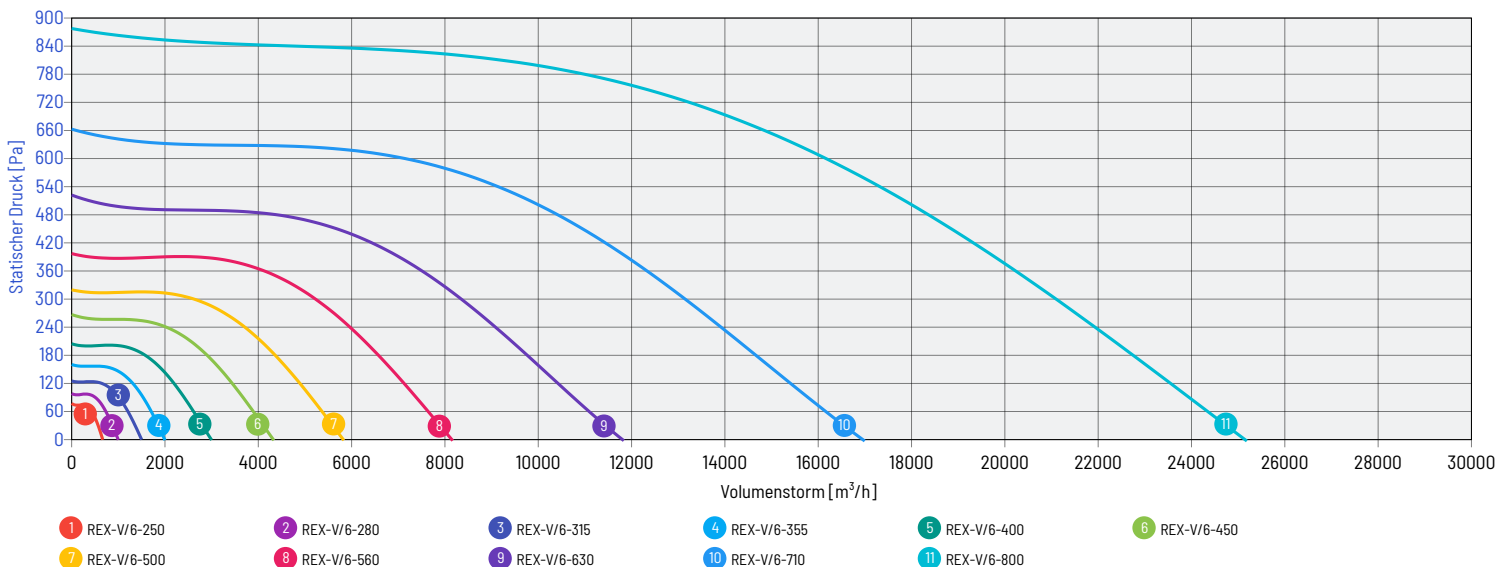

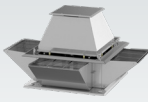

KENNLINIEN DER VENTILATOREN

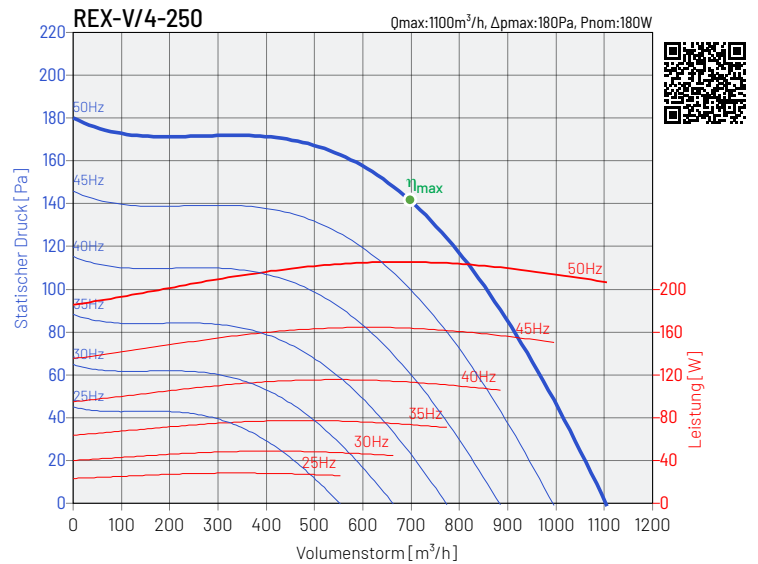
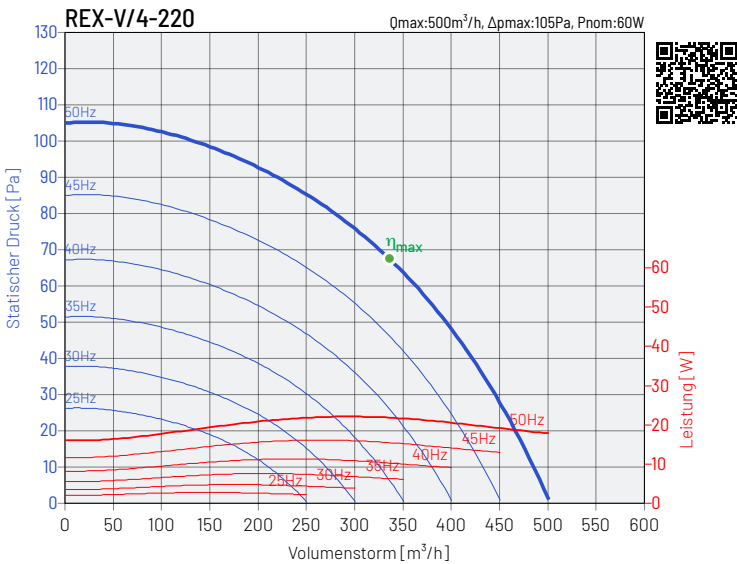
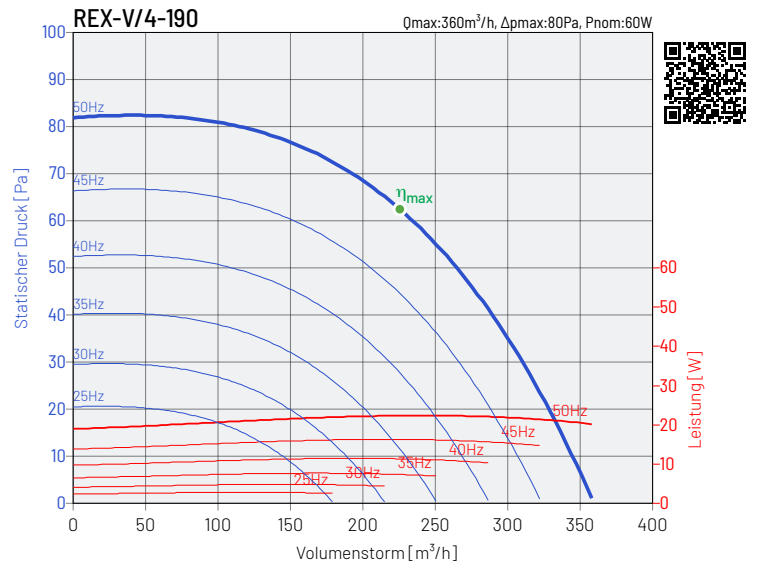
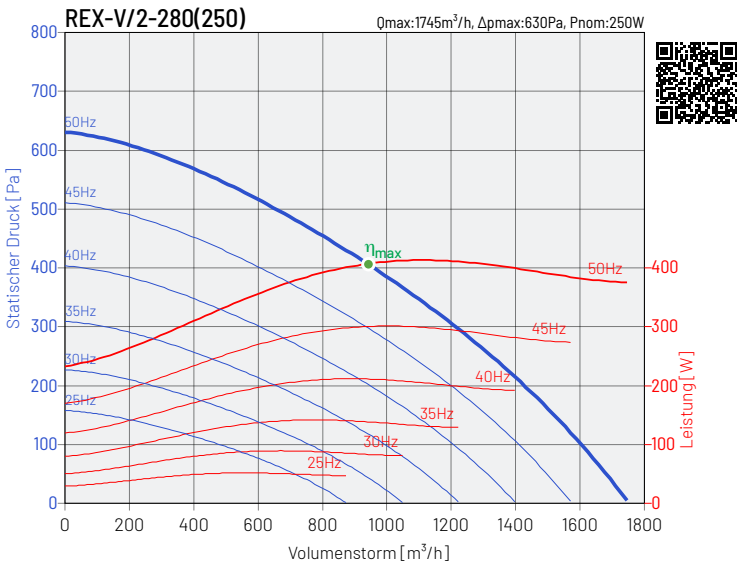
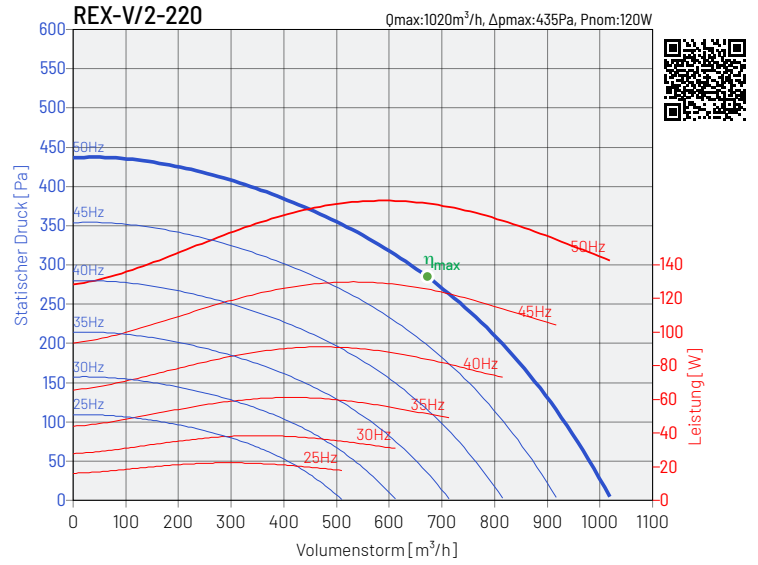
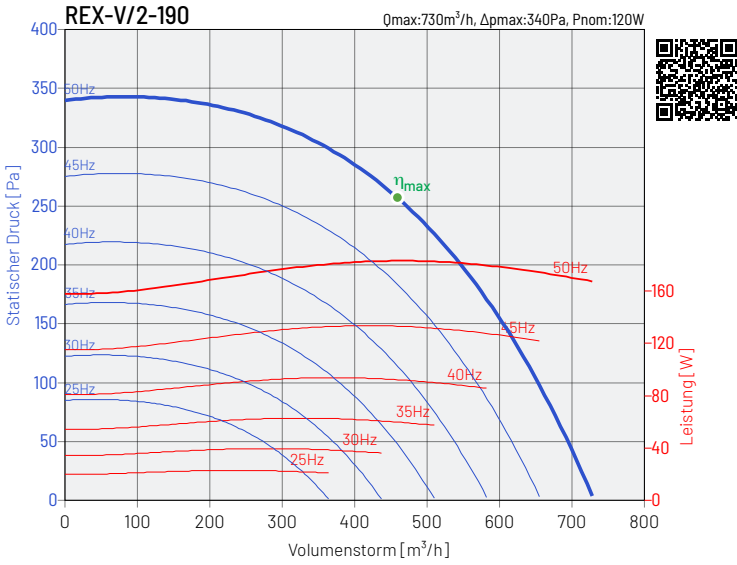

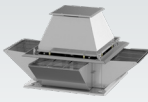

KENNLINIEN DER VENTILATOREN

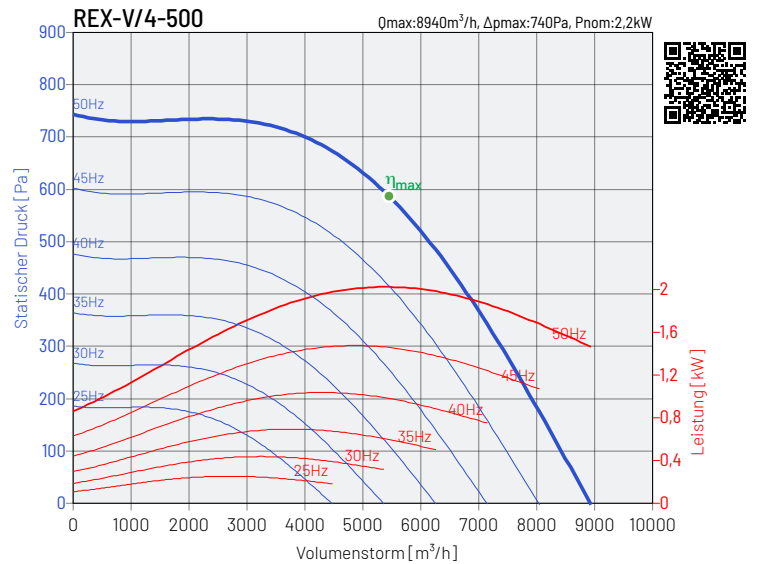
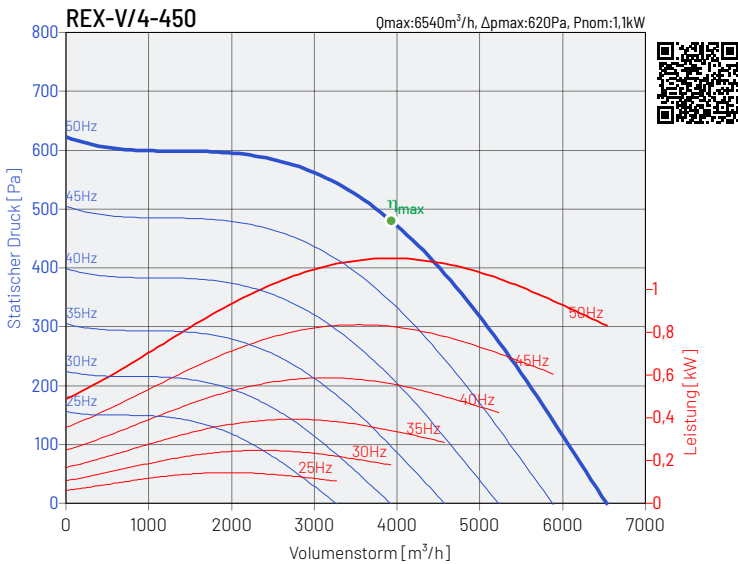
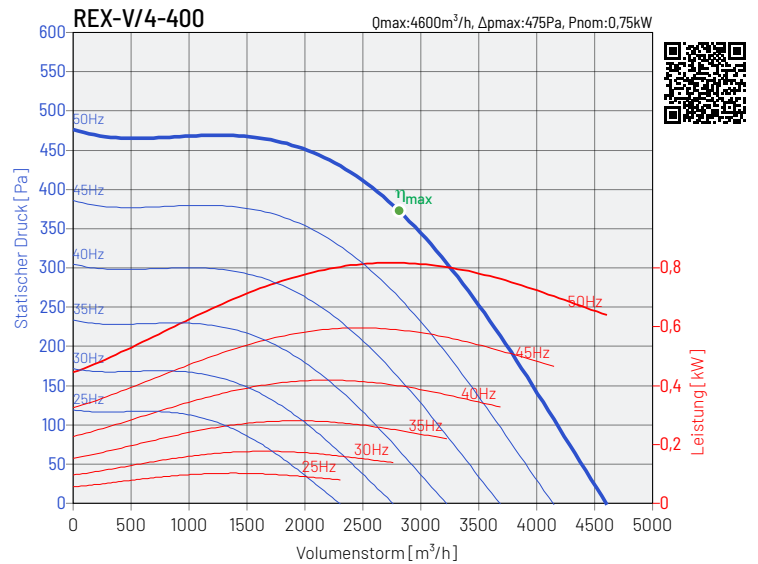
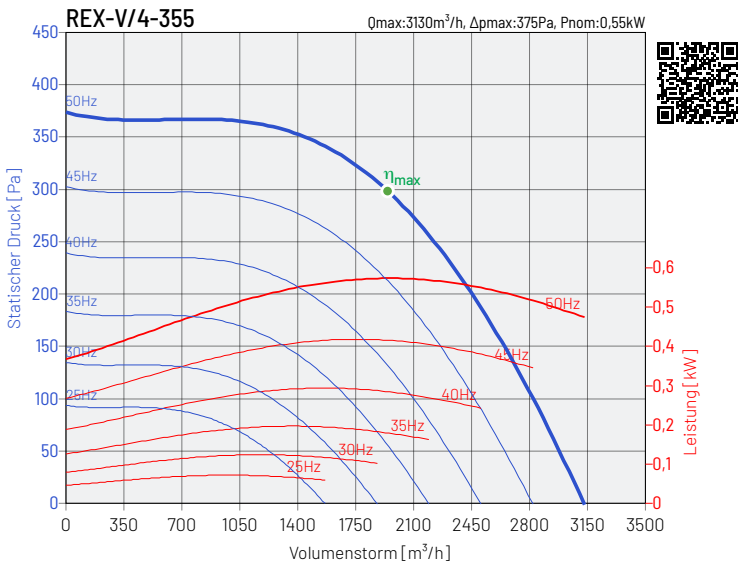
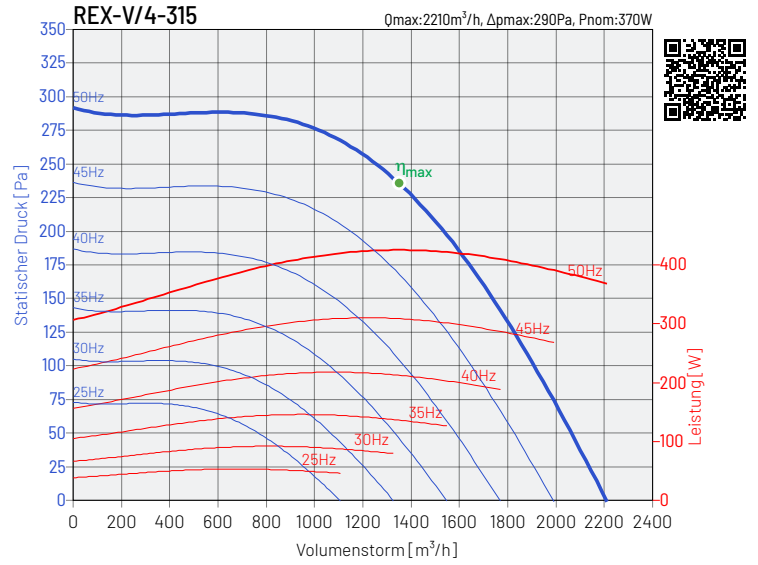
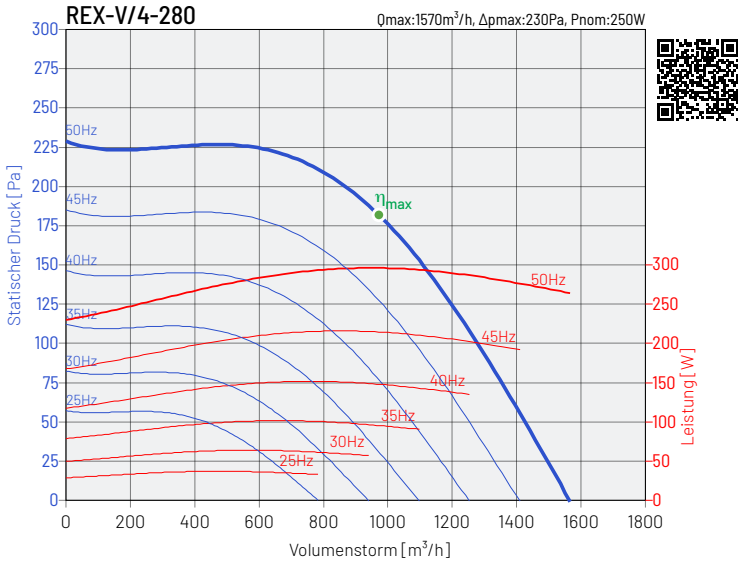

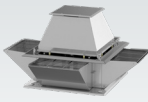

KENNLINIEN DER VENTILATOREN

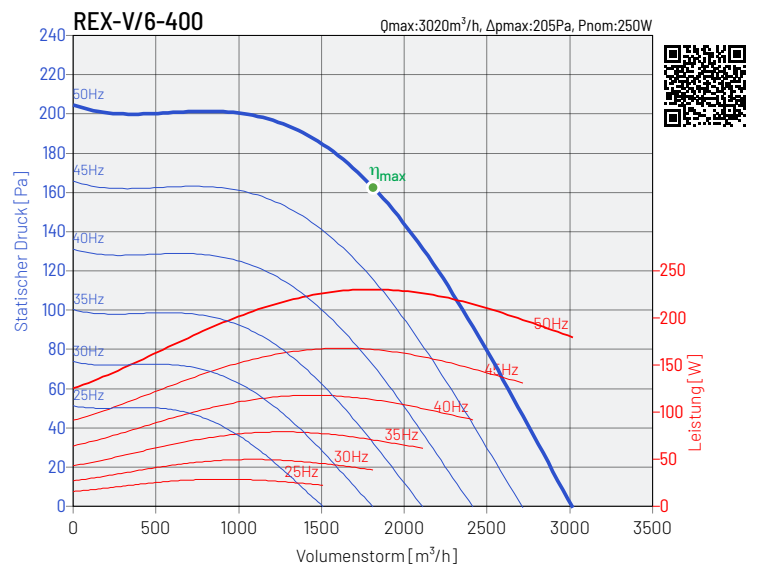
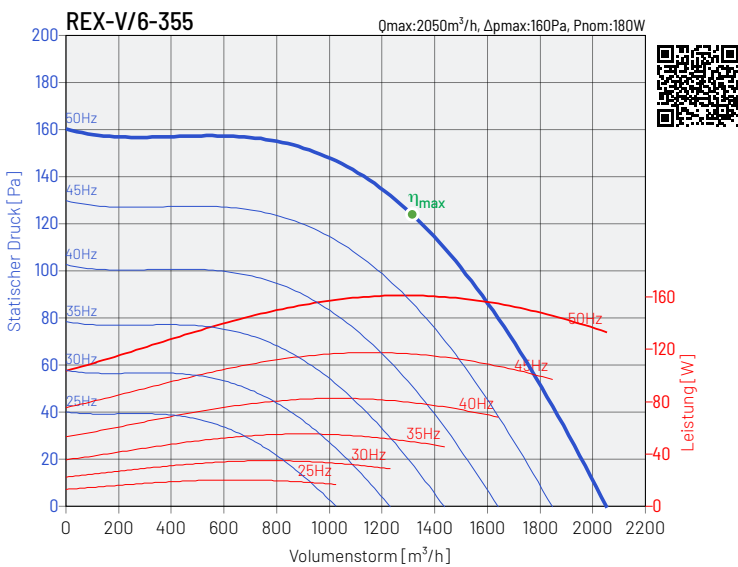
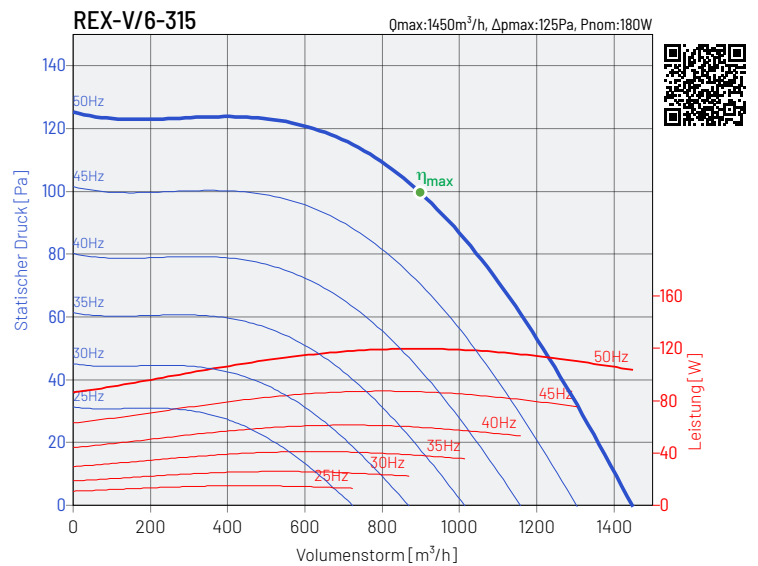
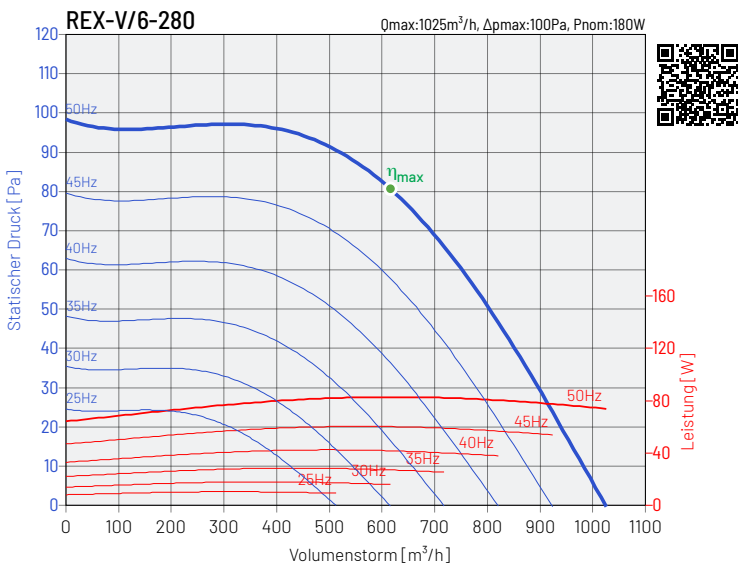
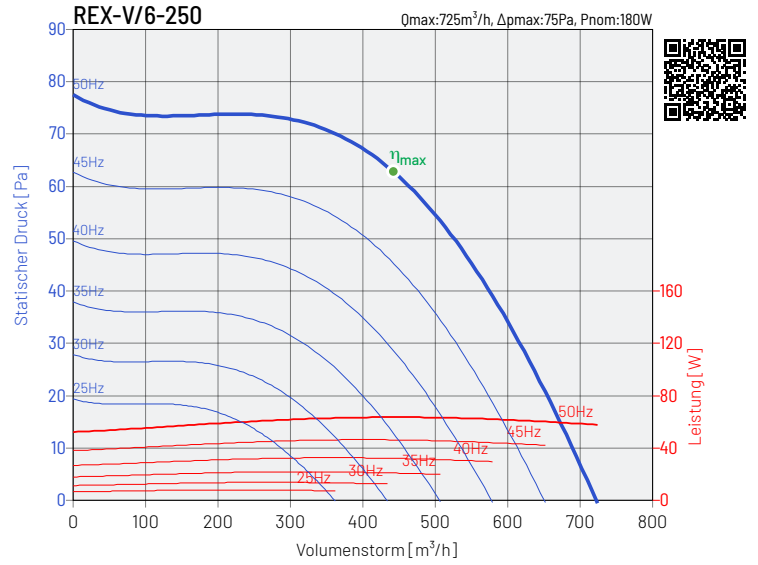
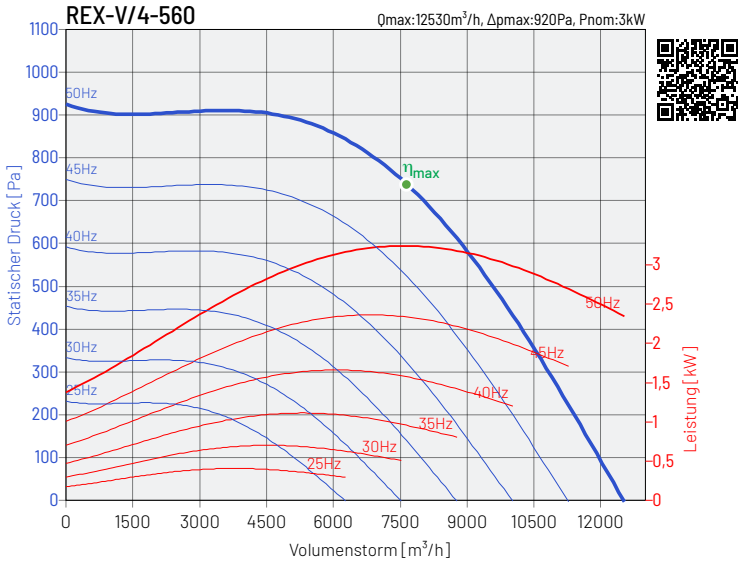

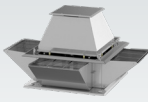

KENNLINIEN DER VENTILATOREN

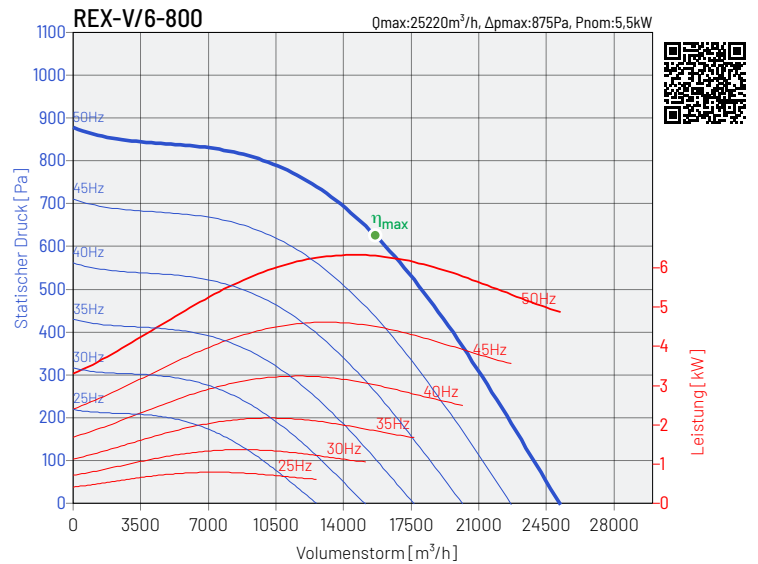
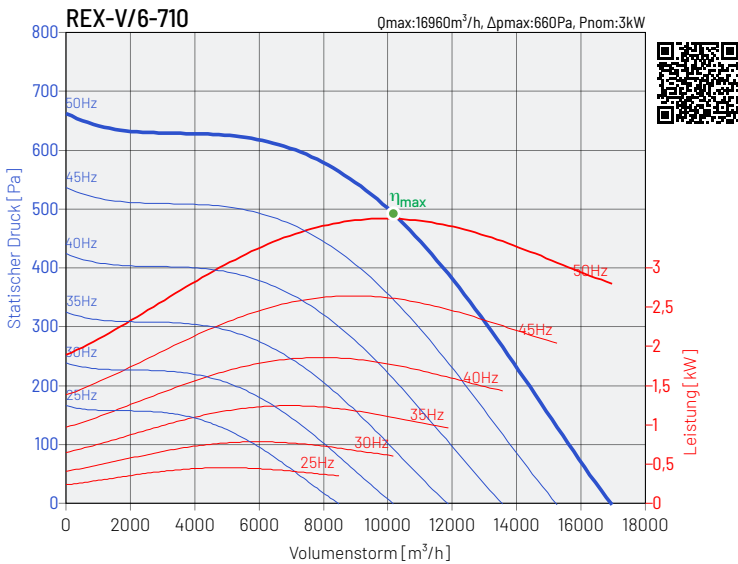
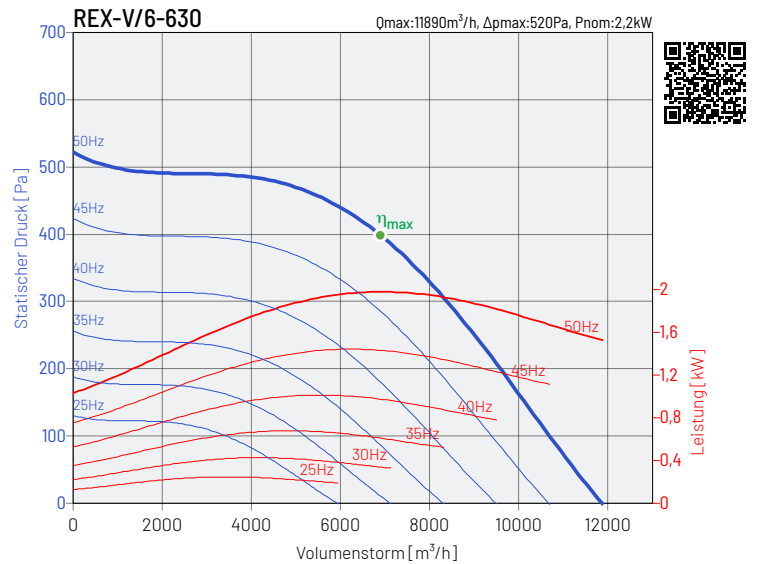
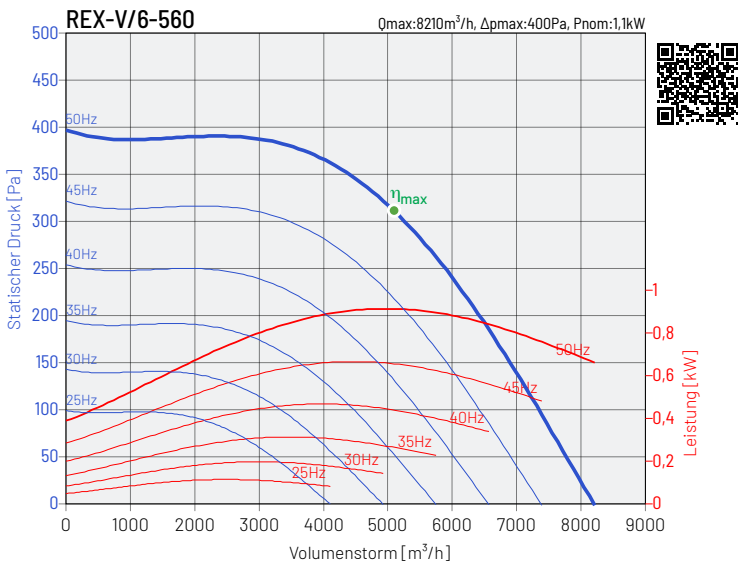
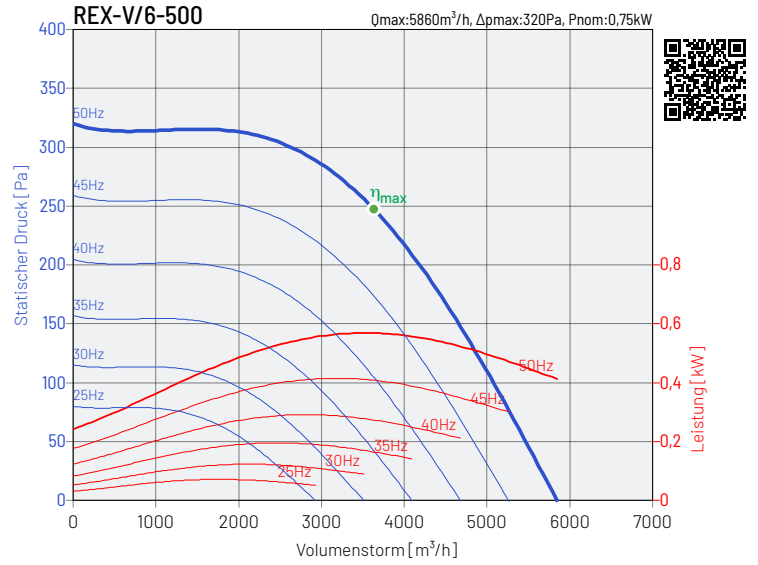
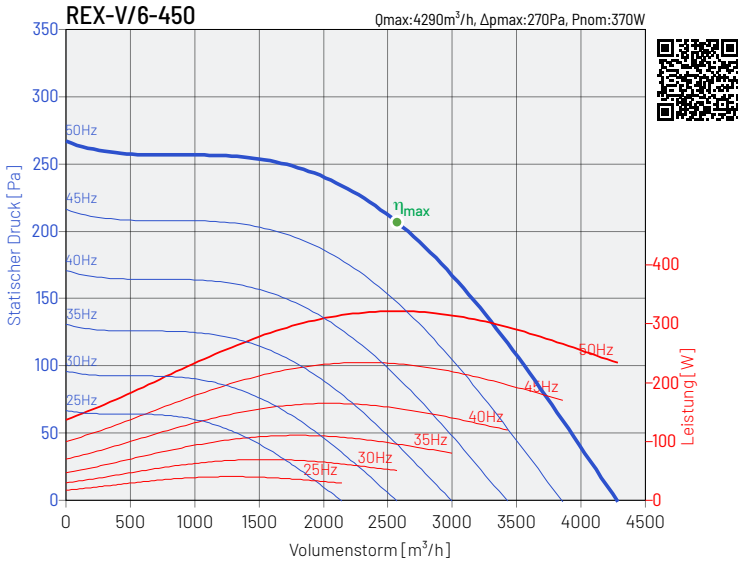

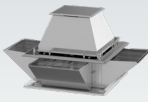

ABMESSUNGEN

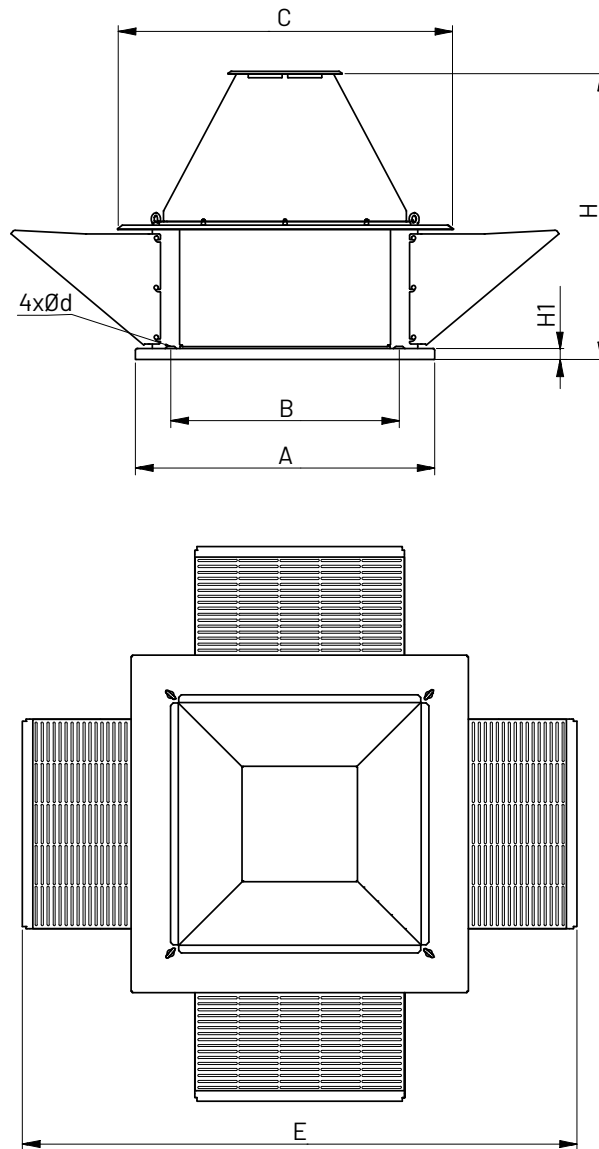

Typ	A mm	B mm	C mm	$\varnothing d$ mm	E mm	H mm	H1 mm
REX-x-190	435	330	386	12	593	385	15
REX-x-220	435	330	386	12	593	385	15
REX-x-250	435	330	441	12	735	453	15
REX-2-280	435	330	441	12	637	416	15
REX-4-280	435	330	441	12	735	453	15
REX-x-315	560	450	513	12	833	495	15
REX-x-355	560	450	583	12	952	540	15

Typ	A mm	B mm	C mm	$\varnothing d$ mm	E mm	H mm	H1 mm
REX-x-400	560	450	653	12	1045	554	15
REX-x-450	710	590	731	12	1212	603	15
REX-x-500	710	590	811	12	1343	707	15
REX-x-560	710	590	896	12	1520	781	15
REX-x-630	900	750	1001	14	1604	797	40
REX-x-710	900	750	1121	14	1782	885	40
REX-x-800	1100	840	1241	14	2040	1060	40

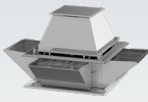

MONTAGEZUBEHÖR

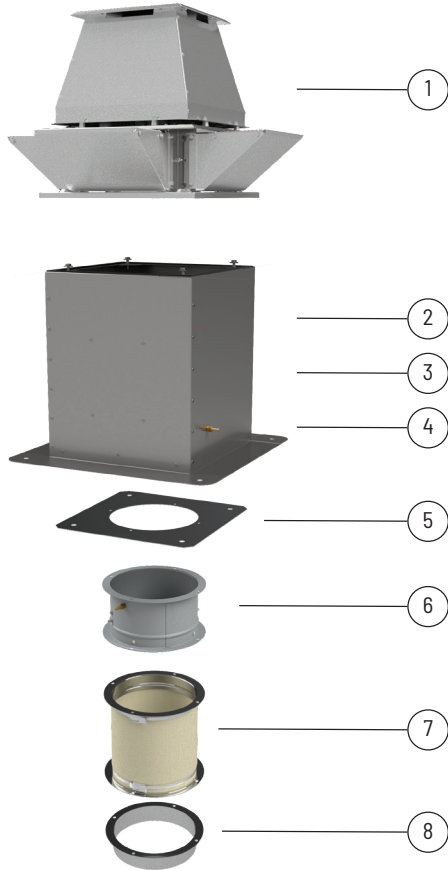

1	2	3	4	5
Typ	Dachsocket RSS/EX	Dachsocket RS/EX	Dachsocket RSA/EX	Montageplatte P/EX
REX-V/x-190	RSS/EX-435	RS/EX-435	RSA/EX-435	P/EX-435
REX-V/x-220	RSS/EX-435	RS/EX-435	RSA/EX-435	P/EX-435
REX-V/x-250	RSS/EX-435	RS/EX-435	RSA/EX-435	P/EX-435
REX-V/x-280	RSS/EX-435	RS/EX-435	RSA/EX-435	P/EX-435
REX-V/x-315	RSS/EX-560	RS/EX-560	RSA/EX-560	P/EX-560
REX-V/x-355	RSS/EX-560	RS/EX-560	RSA/EX-560	P/EX-560
REX-V/x-400	RSS/EX-560	RS/EX-560	RSA/EX-560	P/EX-560
REX-V/x-450	RSS/EX-710	RS/EX-710	RSA/EX-710	P/EX-710
REX-V/x-500	RSS/EX-710	RS/EX-710	RSA/EX-710	P/EX-710
REX-V/x-560	RSS/EX-710	RS/EX-710	RSA/EX-710	P/EX-710
REX-V/x-630	RSS/EX-900	RS/EX-900	RSA/EX-900	P/EX-900
REX-V/x-710	RSS/EX-900	RS/EX-900	RSA/EX-900	P/EX-900
REX-V/x-800	RSS/EX-1100	RS/EX-1100	RSA/EX-1100	P/EX-1100



1	6	7	8
Typ	Verschluss-klappe KZD/EX	Manschette ZPDO/EX	Gegenflansch K/EX
REX-V/x-190	KZD/EX-435	ZPDO/EX-435	K/EX-435
REX-V/x-220	KZD/EX-435	ZPDO/EX-435	K/EX-435
REX-V/x-250	KZD/EX-435	ZPDO/EX-435	K/EX-435
REX-V/x-280	KZD/EX-435	ZPDO/EX-435	K/EX-435
REX-V/x-315	KZD/EX-560	ZPDO/EX-560	K/EX-560
REX-V/x-355	KZD/EX-560	ZPDO/EX-560	K/EX-560
REX-V/x-400	KZD/EX-560	ZPDO/EX-560	K/EX-560
REX-V/x-450	KZD/EX-710	ZPDO/EX-710	K/EX-710
REX-V/x-500	KZD/EX-710	ZPDO/EX-710	K/EX-710
REX-V/x-560	KZD/EX-710	ZPDO/EX-710	K/EX-710
REX-V/x-630	KZD/EX-900	ZPDO/EX-900	K/EX-900
REX-V/x-710	KZD/EX-900	ZPDO/EX-900	K/EX-900
REX-V/x-800	KZD/EX-1100	ZPDO/EX-1100	K/EX-1100

Artikelnummer

43527601	RSS/EX-435	43527621	RSA/EX-435	43527631	P/EX-435	43527641	KZD/EX-435	43527651	ZPDO/EX-435	43527661	K/EX-435
43527602	RSS/EX-560	43527622	RSA/EX-560	43527632	P/EX-560	43527642	KZD/EX-560	43527652	ZPDO/EX-560	43527662	K/EX-560
43527603	RSS/EX-710	43527623	RSA/EX-710	43527633	P/EX-710	43527643	KZD/EX-710	43527653	ZPDO/EX-710	43527663	K/EX-710
43527604	RSS/EX-900	43527624	RSA/EX-900	43527634	P/EX-900	43527644	KZD/EX-900	43527654	ZPDO/EX-900	43527664	K/EX-900
43527605	RSS/EX-1100	43527625	RSA/EX-1100	43527635	P/EX-1100	43527645	KZD/EX-1100	43527655	ZPDO/EX-1100	43527665	K/EX-1100
43527611	RS/EX-435										
43527612	RS/EX-560										
43527613	RS/EX-710										
43527614	RS/EX-900										
43527615	RS/EX-1100										

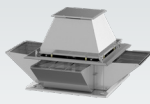

ELEKTRISCHES ZUBEHÖR



Typ	inverter L	Umschalter PTC	Serviceschalter	Schütz
2-POLIGE MOTOREN 3000RPM				
REX-V/2-190-012T 2G	-	U-EK230	R-S 3-F + SP, 16A	DILM7-10(230V50HZ)
REX-V/2-190-012T 2G VFD	L 0,4 kW	U-EK230	R-S 3-F + SP, 16A	DILM7-10(230V50HZ)
REX-V/2-190-012T 2GD VFD	L 0,4 kW	U-EK230	R-S 3-F + SP, 16A	DILM7-10(230V50HZ)
REX-V/2-190-012S 2G	-	U-EK230	R-S 1-F + SP, 16A	DILM7-10(230V50HZ)
REX-V/2-190-012S 2GD	-	U-EK230	R-S 1-F + SP, 16A	DILM7-10(230V50HZ)
REX-V/2-220-012T 2G	-	U-EK230	R-S 3-F + SP, 16A	DILM7-10(230V50HZ)
REX-V/2-220-012T 2G VFD	L 0,4 kW	U-EK230	R-S 3-F + SP, 16A	DILM7-10(230V50HZ)
REX-V/2-220-012T 2GD VFD	L 0,4 kW	U-EK230	R-S 3-F + SP, 16A	DILM7-10(230V50HZ)
REX-V/2-220-012S 2G	-	U-EK230	R-S 1-F + SP, 16A	DILM7-10(230V50HZ)
REX-V/2-220-012S 2GD	-	U-EK230	R-S 1-F + SP, 16A	DILM7-10(230V50HZ)
REX-V/2-280(250)-025T 2G	-	U-EK230	R-S 3-F + SP, 16A	DILM7-10(230V50HZ)
REX-V/2-280(250)-025T 2G VFD	L 0,4 kW	U-EK230	R-S 3-F + SP, 16A	DILM7-10(230V50HZ)
REX-V/2-280(250)-025T 2GD VFD	L 0,4 kW	U-EK230	R-S 3-F + SP, 16A	DILM7-10(230V50HZ)
REX-V/2-280(250)-025S 2G	-	U-EK230	R-S 1-F + SP, 16A	DILM7-10(230V50HZ)
REX-V/2-280(250)-025S 2GD	-	U-EK230	R-S 1-F + SP, 16A	DILM7-10(230V50HZ)
4-POLIGE MOTOREN 1500RPM				
REX-V/4-190-006T 2G	-	U-EK230	R-S 3-F + SP, 16A	DILM7-10(230V50HZ)
REX-V/4-190-012T 2G VFD	L 0,4 kW	U-EK230	R-S 3-F + SP, 16A	DILM7-10(230V50HZ)
REX-V/4-190-012T 2GD VFD	L 0,4 kW	U-EK230	R-S 3-F + SP, 16A	DILM7-10(230V50HZ)
REX-V/4-190-009S 2G	-	U-EK230	R-S 1-F + SP, 16A	DILM7-10(230V50HZ)
REX-V/4-190-009S 2GD	-	U-EK230	R-S 1-F + SP, 16A	DILM7-10(230V50HZ)
REX-V/4-220-006T 2G	-	U-EK230	R-S 3-F + SP, 16A	DILM7-10(230V50HZ)
REX-V/4-220-012T 2G VFD	L 0,4 kW	U-EK230	R-S 3-F + SP, 16A	DILM7-10(230V50HZ)
REX-V/4-220-012T 2GD VFD	L 0,4 kW	U-EK230	R-S 3-F + SP, 16A	DILM7-10(230V50HZ)
REX-V/4-220-009S 2G	-	U-EK230	R-S 1-F + SP, 16A	DILM7-10(230V50HZ)
REX-V/4-220-009S 2GD	-	U-EK230	R-S 1-F + SP, 16A	DILM7-10(230V50HZ)
REX-V/4-250-018T 2G	-	U-EK230	R-S 3-F + SP, 16A	DILM7-10(230V50HZ)
REX-V/4-250-018T 2G VFD	L 0,4 kW	U-EK230	R-S 3-F + SP, 16A	DILM7-10(230V50HZ)
REX-V/4-250-018T 2GD VFD	L 0,4 kW	U-EK230	R-S 3-F + SP, 16A	DILM7-10(230V50HZ)
REX-V/4-250-018S 2G	-	U-EK230	R-S 1-F + SP, 16A	DILM7-10(230V50HZ)
REX-V/4-250-018S 2GD	-	U-EK230	R-S 1-F + SP, 16A	DILM7-10(230V50HZ)
REX-V/4-280-025T 2G	-	U-EK230	R-S 3-F + SP, 16A	DILM7-10(230V50HZ)
REX-V/4-280-025T 2G VFD	L 0,4 kW	U-EK230	R-S 3-F + SP, 16A	DILM7-10(230V50HZ)
REX-V/4-280-025T 2GD VFD	L 0,4 kW	U-EK230	R-S 3-F + SP, 16A	DILM7-10(230V50HZ)
REX-V/4-280-025S 2G	-	U-EK230	R-S 1-F + SP, 16A	DILM7-10(230V50HZ)
REX-V/4-280-025S 2GD	-	U-EK230	R-S 1-F + SP, 16A	DILM7-10(230V50HZ)
REX-V/4-315-037T 2G	-	U-EK230	R-S 3-F + SP, 16A	DILM7-10(230V50HZ)
REX-V/4-315-037T 2G VFD	L 0,4 kW	U-EK230	R-S 3-F + SP, 16A	DILM7-10(230V50HZ)
REX-V/4-315-037T 2GD VFD	L 0,4 kW	U-EK230	R-S 3-F + SP, 16A	DILM7-10(230V50HZ)
REX-V/4-315-037S 2G	-	U-EK230	R-S 1-F + SP, 16A	DILM7-10(230V50HZ)
REX-V/4-315-037S 2GD	-	U-EK230	R-S 1-F + SP, 16A	DILM7-10(230V50HZ)
REX-V/4-355-055T 2G	-	U-EK230	R-S 3-F + SP, 16A	DILM7-10(230V50HZ)
REX-V/4-355-055T 2G VFD	L 0,75 kW	U-EK230	R-S 3-F + SP, 16A	DILM7-10(230V50HZ)
REX-V/4-355-055T 2GD VFD	L 0,75 kW	U-EK230	R-S 3-F + SP, 16A	DILM7-10(230V50HZ)
REX-V/4-355-055S 2G	-	U-EK230	R-S 1-F + SP, 16A	DILM7-10(230V50HZ)
REX-V/4-355-055S 2GD	-	U-EK230	R-S 1-F + SP, 16A	DILM7-10(230V50HZ)
REX-V/4-400-075T 2G	-	U-EK230	R-S 3-F + SP, 16A	DILM7-10(230V50HZ)
REX-V/4-400-075T 2G VFD	L 0,75 kW	U-EK230	R-S 3-F + SP, 16A	DILM7-10(230V50HZ)

* Geräte für den sicheren Bereich, die Ausführung für den ATEX-Bereich sollte mit der technischen Abteilung von Ventur Deutschland GmbH

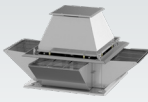

ELEKTRISCHES ZUBEHÖR



Typ	inverter L	Umschalter PTC	Serviceschalter	Schütz
REX-V/4-400-075T 2GD VFD	L 0,75 kW	U-EK230	R-S 3-F + SP, 16A	DILM7-10(230V50HZ)
REX-V/4-400-075S 2G	-	U-EK230	R-S 1-F + SP, 16A	DILM7-10(230V50HZ)
REX-V/4-400-075S 2GD	-	U-EK230	R-S 1-F + SP, 16A	DILM7-10(230V50HZ)
REX-V/4-450-110T 2G	-	U-EK230	R-S 3-F + SP, 16A	DILM7-10(230V50HZ)
REX-V/4-450-110T 2G VFD	L 1,5 kW	U-EK230	R-S 3-F + SP, 16A	DILM7-10(230V50HZ)
REX-V/4-450-110T 2GD VFD	L 1,5 kW	U-EK230	R-S 3-F + SP, 16A	DILM7-10(230V50HZ)
REX-V/4-450-110S 2G	-	U-EK230	R-S 1-F + SP, 16A	DILM7-10(230V50HZ)
REX-V/4-450-110S 2GD	-	U-EK230	R-S 1-F + SP, 16A	DILM7-10(230V50HZ)
REX-V/4-500-220T 2G	-	U-EK230	R-S 3-F + SP, 16A	DILM7-10(230V50HZ)
REX-V/4-500-220T 2G VFD	L 2,2 kW	U-EK230	R-S 3-F + SP, 16A	DILM7-10(230V50HZ)
REX-V/4-500-220T 2GD VFD	L 2,2 kW	U-EK230	R-S 3-F + SP, 16A	DILM7-10(230V50HZ)
REX-V/4-560-300T 2G	-	U-EK230	R-S 3-F + SP, 16A	DILM7-10(230V50HZ)
REX-V/4-560-300T 2G VFD	L 3 kW	U-EK230	R-S 3-F + SP, 16A	DILM7-10(230V50HZ)
REX-V/4-560-300T 2GD VFD	L 3 kW	U-EK230	R-S 3-F + SP, 16A	DILM7-10(230V50HZ)
6-POLIGE MOTOREN 1000RPM				
REX-V/6-250-018T 2G	-	U-EK230	R-S 3-F + SP, 16A	DILM7-10(230V50HZ)
REX-V/6-250-012T 2G VFD	L 0,4 kW	U-EK230	R-S 3-F + SP, 16A	DILM7-10(230V50HZ)
REX-V/6-250-012T 2GD VFD	L 0,4 kW	U-EK230	R-S 3-F + SP, 16A	DILM7-10(230V50HZ)
REX-V/6-280-018T 2G	-	U-EK230	R-S 3-F + SP, 16A	DILM7-10(230V50HZ)
REX-V/6-280-012T 2G VFD	L 0,4 kW	U-EK230	R-S 3-F + SP, 16A	DILM7-10(230V50HZ)
REX-V/6-280-012T 2GD VFD	L 0,4 kW	U-EK230	R-S 3-F + SP, 16A	DILM7-10(230V50HZ)
REX-V/6-315-018T 2G	-	U-EK230	R-S 3-F + SP, 16A	DILM7-10(230V50HZ)
REX-V/6-315-012T 2G VFD	L 0,4 kW	U-EK230	R-S 3-F + SP, 16A	DILM7-10(230V50HZ)
REX-V/6-315-012T 2GD VFD	L 0,4 kW	U-EK230	R-S 3-F + SP, 16A	DILM7-10(230V50HZ)
REX-V/6-355-018T 2G	-	U-EK230	R-S 3-F + SP, 16A	DILM7-10(230V50HZ)
REX-V/6-355-018T 2G VFD	L 0,4 kW	U-EK230	R-S 3-F + SP, 16A	DILM7-10(230V50HZ)
REX-V/6-355-018T 2GD VFD	L 0,4 kW	U-EK230	R-S 3-F + SP, 16A	DILM7-10(230V50HZ)
REX-V/6-400-025T 2G	-	U-EK230	R-S 3-F + SP, 16A	DILM7-10(230V50HZ)
REX-V/6-400-025T 2G VFD	L 0,4 kW	U-EK230	R-S 3-F + SP, 16A	DILM7-10(230V50HZ)
REX-V/6-400-025T 2GD VFD	L 0,4 kW	U-EK230	R-S 3-F + SP, 16A	DILM7-10(230V50HZ)
REX-V/6-450-037T 2G	-	U-EK230	R-S 3-F + SP, 16A	DILM7-10(230V50HZ)
REX-V/6-450-037T 2G VFD	L 0,4 kW	U-EK230	R-S 3-F + SP, 16A	DILM7-10(230V50HZ)
REX-V/6-450-037T 2GD VFD	L 0,4 kW	U-EK230	R-S 3-F + SP, 16A	DILM7-10(230V50HZ)
REX-V/6-500-075T 2G	-	U-EK230	R-S 3-F + SP, 16A	DILM7-10(230V50HZ)
REX-V/6-500-075T 2G VFD	L 0,75 kW	U-EK230	R-S 3-F + SP, 16A	DILM7-10(230V50HZ)
REX-V/6-500-075T 2GD VFD	L 0,75 kW	U-EK230	R-S 3-F + SP, 16A	DILM7-10(230V50HZ)
REX-V/6-560-110T 2G	-	U-EK230	R-S 3-F + SP, 16A	DILM7-10(230V50HZ)
REX-V/6-560-110T 2G VFD	L 1,5 kW	U-EK230	R-S 3-F + SP, 16A	DILM7-10(230V50HZ)
REX-V/6-560-110T 2GD VFD	L 1,5 kW	U-EK230	R-S 3-F + SP, 16A	DILM7-10(230V50HZ)
REX-V/6-630-220T 2G	-	U-EK230	R-S 3-F + SP, 16A	DILM7-10(230V50HZ)
REX-V/6-630-220T 2G VFD	L 2,2 kW	U-EK230	R-S 3-F + SP, 16A	DILM7-10(230V50HZ)
REX-V/6-630-220T 2GD VFD	L 2,2 kW	U-EK230	R-S 3-F + SP, 16A	DILM7-10(230V50HZ)
REX-V/6-710-300T 2G	-	U-EK230	R-S 3-F + SP, 16A	DILM7-10(230V50HZ)
REX-V/6-710-300T 2G VFD	L 4,0 kW	U-EK230	R-S 3-F + SP, 16A	DILM7-10(230V50HZ)
REX-V/6-710-300T 2GD VFD	L 4,0 kW	U-EK230	R-S 3-F + SP, 16A	DILM7-10(230V50HZ)
REX-V/6-800-550T 2G	-	U-EK230	R-S 3-F + SP, 25A/6	DILM12-10(230V50HZ)
REX-V/6-800-550T 2G VFD	L 5,5 kW	U-EK230	R-S 3-F + SP, 25A	DILM12-10(230V50HZ)
REX-V/6-800-550T 2GD VFD	L 5,5 kW	U-EK230	R-S 3-F + SP, 25A	DILM12-10(230V50HZ)

* Geräte für den sicheren Bereich, die Ausführung für den ATEX-Bereich sollte mit der technischen Abteilung von Ventur Deutschland GmbH