



ZASTOSOWANIE

Wentylator przeznaczony do wszelkiego rodzaju instalacji wentylacji ogólnej. Typowe zastosowania to:

- wentylacja mieszkań, biur,
- wentylacja sklepów, barów, kawiarni, restauracji,
- wentylacja sal szkolnych, studiów dźwiękowych, bibliotek,
- wentylacja kuchni przemysłowych.

KONSTRUKCJA

- wentylator promieniowy z napędem bezpośrednim,
- obudowa z blachy aluminiowej,
- ognioodporna warstwa izolacji akustycznej (włókno szklane MO) o grubości 25mm,
- wirnik z blachy aluminiowej, z łopatkami pochylonymi do tyłu (CVAB-N),
- wirnik z blachy stalowej, z łopatkami pochylonymi do tyłu (CVAT-N),
- silnik w przepływie medium,
- króćce przyłączeniowe o profilu okrągłym,
- montaż w pozycji poziomej,
- puszka przyłączeniowa na obudowie (CVAB-N),
- możliwość montażu zewnętrznego przy zastosowaniu odpowiedniej osłony (na zapytanie).

SILNIK ELEKTRYCZNY

- silniki jednofazowe 230 V, 50Hz (CVAB-N),
- silnik trójfazowy 230/400V, 50Hz (CVAT-N),
- stopień ochrony IP55, klasa izolacji F,
- do regulacji napięciowej (silniki jednofazowe),
- do regulacji częstotliwościowej (silniki trójfazowe),
- termiczne zabezpieczenie uzwojenia przed przeciążeniem.



Wersja do stref zagrożenia wybuchem - CVAT-N EX

DANE TECHNICZNE

Typ	prędkość obrotowa [obr./min]	pobór mocy max [W]	natężenie 230V 400V		wydaj. max [m³/h]	poziom ciśn. akust.* [dB(A)]			temp. pracy min max [°C]	masa [kg]	regulator	ErP	nr artykułu	
			[A]			wlot	emit.	wylot						
JEDNOFAZOWE 4 BIEGUNOWE														
CVAB/4-1400/250N D	1300	107	0,5	-	1280	49	44	50	-40	+60	13	TLR 15 DS/RVS-1,5	2018	41020325
CVAB/4-2000/315N D	1390	169	0,7	-	1820	53	47	54	-40	+60	13	TLR 15 DS/RVS-1,5	2018	41020335
CVAB/4-3000/355N D	1370	312	1,3	-	2800	58	51	58	-40	+60	30	TLR 15 DS/RVS-1,5	2018	41020345
CVAB/4-4000/400N D	1390	557	2,3	-	4210	62	54	60	-40	+60	32	TLR 25 DS/RVS-3	2018	41020355
CVAB/4-6000/450N D	1380	930	4	-	6140	64	57	63	-40	+60	46	REB 5/RVS-5	2018	41020365
CVAB/4-9000/500N D	1390	1289	5,5	-	7580	68	61	66	-40	+60	58	REB 10/RVS-7	2018	41020370
TRÓJFAZOWE 4 BIEGUNOWE														
CVAT/4-1400/250N D 0,18	1480	116	0,9	0,5	1.230	50	37	48	-20	+40	13	falownik 0.4 kW	2018	41020525
CVAT/4-2000/315N D 0,18	1460	169	0,9	0,5	1.830	54	41	53	-20	+40	13	falownik 0.4 kW	2018	41020535
CVAT/4-3000/355N D 0,18	1430	251	0,9	0,5	2.660	56	43	56	-20	+40	30	falownik 0.4 kW	2018	41020545
CVAT/4-4000/400N D 0,37	1445	438	1,6	0,9	3.850	60	47	60	-20	+40	32	falownik 0.4 kW	2018	41020555
CVAT/4-6000/450N D 0,75	1465	747	3,0	1,7	5.620	63	50	64	-20	+40	46	falownik 0.75 kW	2018	41020565
CVAT/4-9000/500N D 1,1	1480	1347	4,4	2,5	7.900	67	53	68	-20	+40	58	falownik 1.5 kW	2018	41020575
CVAT/4-12000/560N D 2,2	1470	2093	7,3	4,2	11.100	69	56	71	-20	+40	82	falownik 2.2 kW	2018	41020595
CVAT/4-16000/630N D 3	1460	3234	10,3	5,9	14.640	72	60	75	-20	+40	113	falownik 4.0 kW	2018	41020607
TRÓJFAZOWE 6 BIEGUNOWE														
CVAT/6-15000/710N D 1,5	970	1828	6,3	3,6	14.320	72	60	74	-20	+40	149	falownik 1.5 kW	2018	41020605

* pomiar z odległości 1,5 m od wentylatora

CHARAKTERYSTYKI PRACY I CHARAKTERYSTYKI AKUSTYCZNE

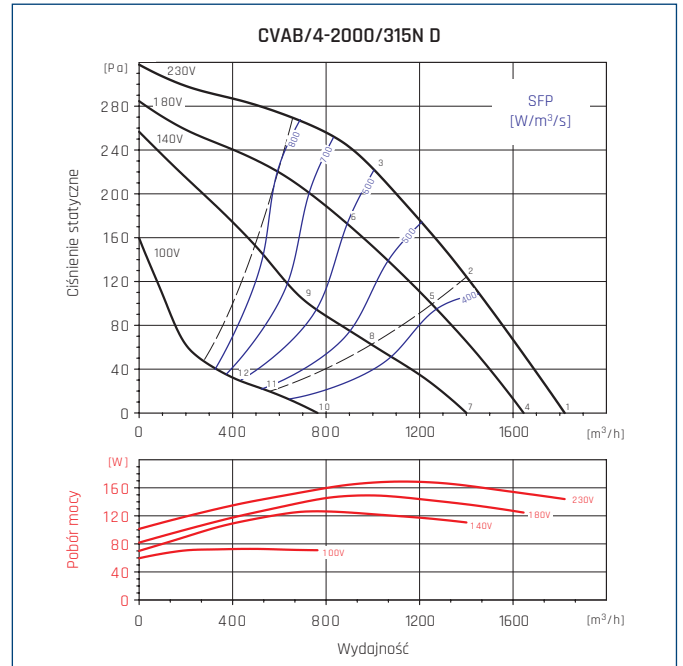
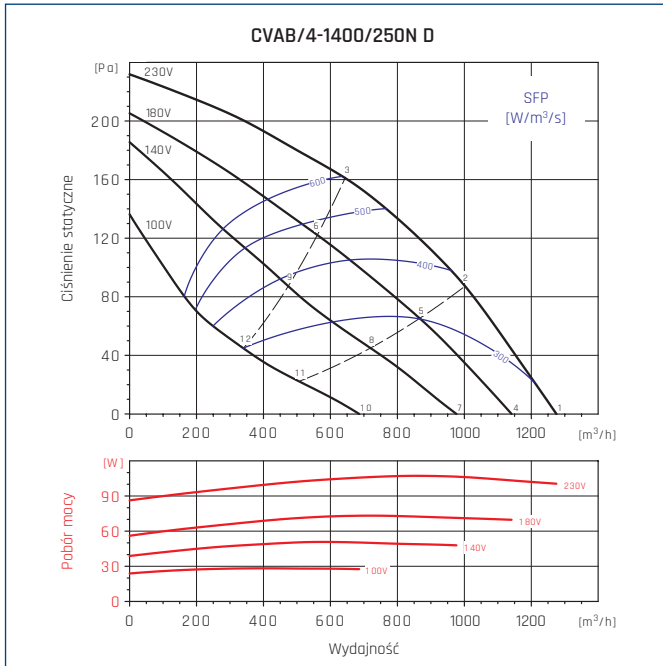

Częst. Hz/dB(A)		63	125	250	500	1000	2000	4000	8000	L _{WA}
1	Wlot	32	50	58	59	61	57	56	37	66
	Wylot	35	49	57	59	60	56	49	35	65
	Emitowany	26	43	46	49	55	56	51	28	60
2	Wlot	28	48	56	57	59	57	53	36	64
	Wylot	29	47	55	57	61	58	47	35	64
	Emitowany	22	41	44	48	54	56	48	27	59
3	Wlot	26	47	53	56	60	58	44	52	64
	Wylot	27	44	52	57	62	61	51	41	66
	Emitowany	21	41	42	47	54	57	47	35	60
4	Wlot	32	32	57	57	59	57	56	35	64
	Wylot	33	31	55	57	55	58	48	32	63
	Emitowany	26	28	42	47	54	56	51	27	60
5	Wlot	26	30	54	55	57	56	49	33	62
	Wylot	27	30	52	55	55	58	44	31	62
	Emitowany	21	25	39	46	53	55	45	25	58
6	Wlot	26	29	53	55	58	56	48	38	62
	Wylot	26	31	50	55	60	60	46	38	64
	Emitowany	20	25	38	46	54	55	44	31	58
7	Wlot	30	44	55	55	56	56	48	31	62
	Wylot	30	44	53	54	56	53	43	31	61
	Emitowany	23	38	40	45	51	54	42	22	56
8	Wlot	25	41	54	53	55	55	39	31	60
	Wylot	25	40	50	53	57	52	36	29	60
	Emitowany	18	35	39	43	50	53	33	21	55
9	Wlot	23	37	49	51	54	50	41	33	58
	Wylot	24	39	48	52	58	54	41	32	60
	Emitowany	17	31	34	41	49	48	35	24	52
10	Wlot	27	35	48	49	52	49	33	26	56
	Wylot	28	39	47	50	51	48	32	26	55
	Emitowany	22	30	34	50	47	42	26	17	52
11	Wlot	23	34	45	48	50	41	30	26	53
	Wylot	26	36	43	47	49	39	28	25	52
	Emitowany	18	29	31	41	48	38	23	17	49
12	Wlot	23	34	43	47	47	36	28	32	51
	Wylot	23	35	40	45	50	38	30	27	52
	Emitowany	17	29	30	40	45	34	25	19	47

Częst. Hz/dB(A)		63	125	250	500	1000	2000	4000	8000	L _{WA}
1	Wlot	37	55	63	64	65	62	60	45	70
	Wylot	40	55	61	64	65	60	54	42	69
	Emitowany	32	50	52	55	58	58	53	35	63
2	Wlot	32	53	60	62	63	60	56	42	68
	Wylot	35	52	59	61	65	61	51	40	68
	Emitowany	27	48	50	53	57	57	49	33	61
3	Wlot	32	52	58	61	63	61	47	55	67
	Wylot	32	49	56	60	64	62	53	44	68
	Emitowany	26	46	47	51	57	57	49	38	61
4	Wlot	37	37	62	63	63	62	59	43	69
	Wylot	39	35	60	62	59	64	53	40	68
	Emitowany	32	31	49	53	58	58	53	34	62
5	Wlot	31	34	59	60	61	59	53	40	66
	Wylot	33	33	57	59	58	62	48	37	66
	Emitowany	26	29	46	51	55	56	47	31	60
6	Wlot	31	33	56	58	60	58	52	42	65
	Wylot	31	33	54	58	60	62	49	41	66
	Emitowany	25	27	43	49	55	55	46	35	59
7	Wlot	35	50	59	60	60	60	53	39	66
	Wylot	36	50	57	59	60	57	48	37	65
	Emitowany	30	45	46	50	55	56	47	29	60
8	Wlot	29	46	56	56	57	56	44	35	63
	Wylot	30	45	53	55	59	54	41	32	62
	Emitowany	24	41	43	47	52	53	38	25	56
9	Wlot	27	41	51	53	55	52	44	36	59
	Wylot	28	44	49	53	58	54	42	34	61
	Emitowany	22	36	38	43	50	48	37	27	53
10	Wlot	29	40	49	51	53	51	36	29	57
	Wylot	30	42	47	50	52	48	34	28	56
	Emitowany	26	35	38	50	48	45	30	21	53
11	Wlot	24	38	46	48	49	43	32	27	53
	Wylot	27	39	44	47	50	41	31	26	53
	Emitowany	21	34	35	42	47	40	26	20	49
12	Wlot	22	36	43	45	46	38	28	33	50
	Wylot	24	37	41	45	50	40	31	27	52
	Emitowany	19	31	31	39	43	35	26	20	45

● - punkt najwyższej sprawności wentylatora.

CHARAKTERYSTYKI PRACY I CHARAKTERYSTYKI AKUSTYCZNE

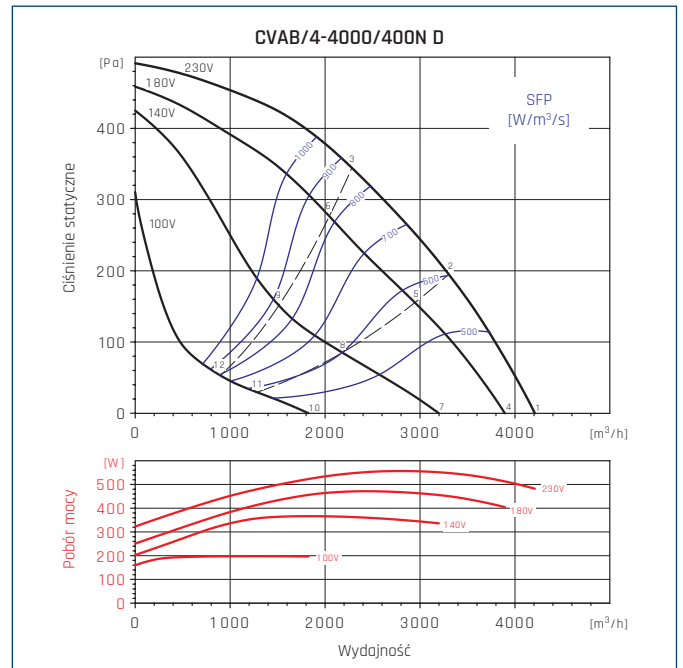
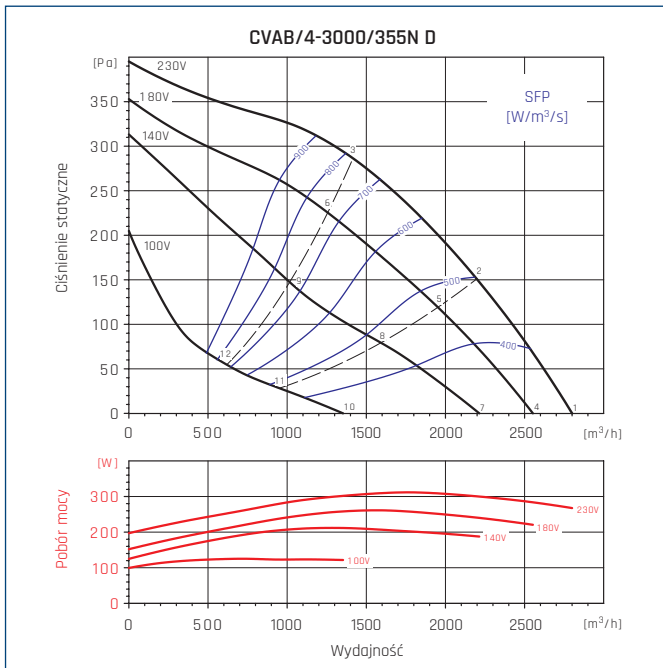

Częst. Hz/dB(A)		63	125	250	500	1000	2000	4000	8000	L _{WA}
1	Wlot	32	50	58	59	61	57	56	37	66
	Wylot	35	49	57	59	60	56	49	35	65
	Emitowany	26	43	46	49	55	56	51	28	60
2	Wlot	28	48	56	57	59	57	53	36	64
	Wylot	29	47	55	57	61	58	47	35	64
	Emitowany	22	41	44	48	54	56	48	27	59
3	Wlot	26	47	53	56	60	58	44	52	64
	Wylot	27	44	52	57	62	61	51	41	66
	Emitowany	21	41	42	47	54	57	47	35	60
4	Wlot	32	32	57	57	59	57	56	35	64
	Wylot	33	31	55	57	55	58	48	32	63
	Emitowany	26	28	42	47	54	56	51	27	60
5	Wlot	26	30	54	55	57	56	49	33	62
	Wylot	27	30	52	55	55	58	44	31	62
	Emitowany	21	25	39	46	53	55	45	25	58
6	Wlot	26	29	53	55	58	56	48	38	62
	Wylot	26	31	50	55	60	60	46	38	64
	Emitowany	20	25	38	46	54	55	44	31	58
7	Wlot	30	44	55	55	56	56	48	31	62
	Wylot	30	44	53	54	56	53	43	31	61
	Emitowany	23	38	40	45	51	54	42	22	56
8	Wlot	25	41	54	53	55	55	39	31	60
	Wylot	25	40	50	53	57	52	36	29	60
	Emitowany	18	35	39	43	50	53	33	21	55
9	Wlot	23	37	49	51	54	50	41	33	58
	Wylot	24	39	48	52	58	54	41	32	60
	Emitowany	17	31	34	41	49	48	35	24	52
10	Wlot	27	35	48	49	52	49	33	26	56
	Wylot	28	39	47	50	51	48	32	26	55
	Emitowany	22	30	34	50	47	42	26	17	52
11	Wlot	23	34	45	48	50	41	30	26	53
	Wylot	26	36	43	47	49	39	28	25	52
	Emitowany	18	29	31	41	48	38	23	17	49
12	Wlot	23	34	43	47	47	36	28	32	51
	Wylot	23	35	40	45	50	38	30	27	52
	Emitowany	17	29	30	40	45	34	25	19	47

Częst. Hz/dB(A)		63	125	250	500	1000	2000	4000	8000	L _{WA}
1	Wlot	37	55	63	64	65	62	60	45	70
	Wylot	40	55	61	64	65	60	54	42	69
	Emitowany	32	50	52	55	58	58	53	35	63
2	Wlot	32	53	60	62	63	60	56	42	68
	Wylot	35	52	59	61	65	61	51	40	68
	Emitowany	27	48	50	53	57	57	49	33	61
3	Wlot	32	52	58	61	63	61	47	55	67
	Wylot	32	49	56	60	64	62	53	44	68
	Emitowany	26	46	47	51	57	57	49	38	61
4	Wlot	37	37	62	63	63	62	59	43	69
	Wylot	39	35	60	62	59	64	53	40	68
	Emitowany	32	31	49	53	58	58	53	34	62
5	Wlot	31	34	59	60	61	59	53	40	66
	Wylot	33	33	57	59	58	62	48	37	66
	Emitowany	26	29	46	51	55	56	47	31	60
6	Wlot	31	33	56	58	60	58	52	42	65
	Wylot	31	33	54	58	60	62	49	41	66
	Emitowany	25	27	43	49	55	55	46	35	59
7	Wlot	35	50	59	60	60	60	53	39	66
	Wylot	36	50	57	59	60	57	48	37	65
	Emitowany	30	45	46	50	55	56	47	29	60
8	Wlot	29	46	56	56	57	56	44	35	63
	Wylot	30	45	53	55	59	54	41	32	62
	Emitowany	24	41	43	47	52	53	38	25	56
9	Wlot	27	41	51	53	55	52	44	36	59
	Wylot	28	44	49	53	58	54	42	34	61
	Emitowany	22	36	38	43	50	48	37	27	53
10	Wlot	29	40	49	51	53	51	36	29	57
	Wylot	30	42	47	50	52	48	34	28	56
	Emitowany	26	35	38	50	48	45	30	21	53
11	Wlot	24	38	46	48	49	43	32	27	53
	Wylot	27	39	44	47	50	41	31	26	53
	Emitowany	21	34	35	42	47	40	26	20	49
12	Wlot	22	36	43	45	46	38	28	33	50
	Wylot	24	37	41	45	50	40	31	27	52
	Emitowany	19	31	31	39	43	35	26	20	45

• - punkt najwyższej sprawności wentylatora.

CHARAKTERYSTYKI PRACY I CHARAKTERYSTYKI AKUSTYCZNE

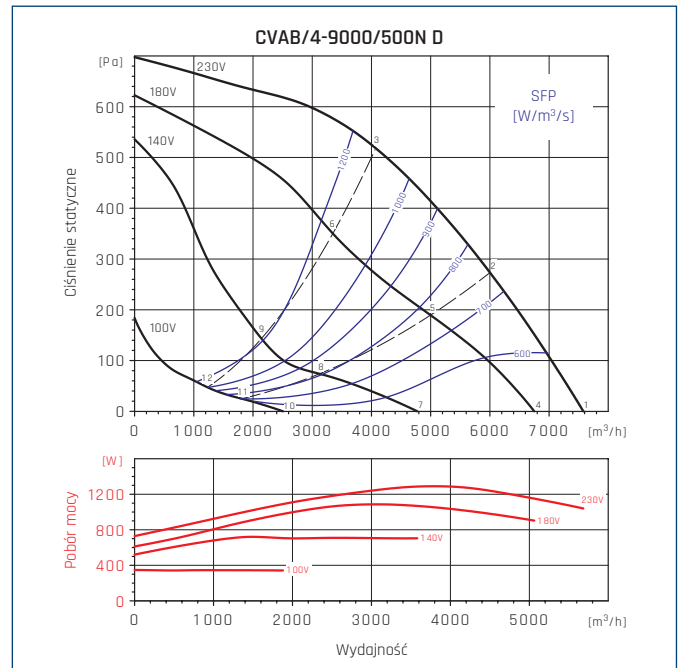
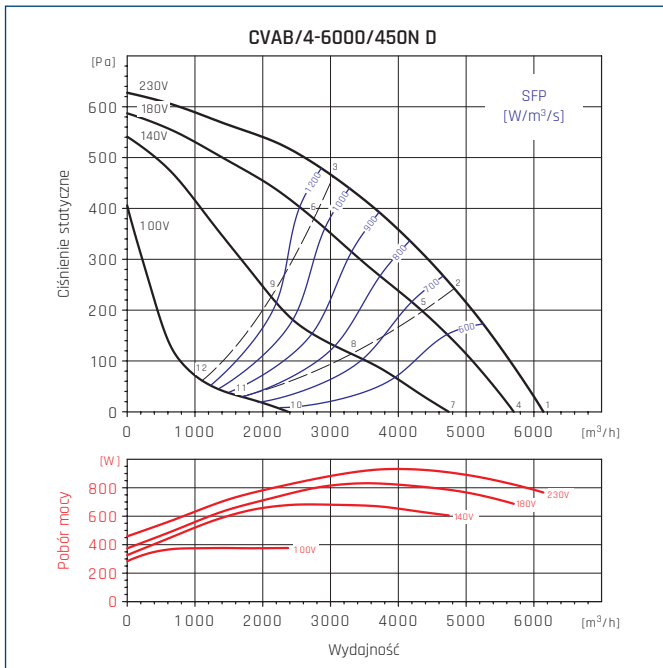

Częst. Hz/dB(A)		63	125	250	500	1000	2000	4000	8000	L _{WA}
1	Wlot	41	60	66	68	67	65	62	51	73
	Wylot	45	59	65	67	68	63	57	47	73
	Emitowany	36	55	57	59	61	59	54	41	66
2	Wlot	38	60	66	67	67	64	59	50	73
	Wylot	40	58	63	66	69	64	55	46	72
	Emitowany	33	55	57	58	60	58	52	40	65
3	Wlot	38	58	63	66	67	64	52	59	72
	Wylot	38	54	60	64	67	64	56	48	71
	Emitowany	33	53	54	56	60	58	51	42	64
4	Wlot	40	40	65	67	66	64	61	49	72
	Wylot	43	38	63	65	62	67	56	45	71
	Emitowany	35	34	55	57	59	58	53	39	64
5	Wlot	37	38	63	65	65	63	57	47	70
	Wylot	39	37	61	63	61	66	52	43	69
	Emitowany	32	32	53	55	58	56	49	37	62
6	Wlot	36	36	60	62	63	61	55	46	68
	Wylot	36	36	58	61	61	64	53	44	68
	Emitowany	31	30	49	53	57	55	48	38	61
7	Wlot	38	55	62	63	62	61	57	44	69
	Wylot	41	54	60	61	63	59	52	40	68
	Emitowany	35	49	52	54	57	56	50	35	62
8	Wlot	33	52	58	59	59	58	50	39	65
	Wylot	35	51	56	58	61	56	46	36	64
	Emitowany	30	46	48	50	53	52	43	30	58
9	Wlot	31	47	53	55	57	54	48	40	62
	Wylot	32	49	51	55	59	55	45	36	62
	Emitowany	27	41	43	47	51	48	41	30	55
10	Wlot	31	45	51	53	53	53	40	31	59
	Wylot	33	46	48	50	54	48	37	30	57
	Emitowany	29	40	41	49	47	46	32	23	53
11	Wlot	26	43	48	50	50	47	36	30	56
	Wylot	29	44	46	48	52	44	35	29	55
	Emitowany	24	38	38	43	45	41	28	22	49
12	Wlot	24	41	45	47	47	43	31	36	52
	Wylot	26	42	44	47	51	44	34	29	54
	Emitowany	23	36	35	40	43	37	28	23	46

Częst. Hz/dB(A)		63	125	250	500	1000	2000	4000	8000	L _{WA}
1	Wlot	46	65	71	73	71	69	66	58	78
	Wylot	50	65	69	71	73	68	62	54	77
	Emitowany	42	61	63	64	64	61	57	48	70
2	Wlot	42	65	69	71	70	67	61	56	76
	Wylot	45	62	66	69	71	65	58	51	75
	Emitowany	37	60	62	62	63	58	52	46	68
3	Wlot	43	63	68	70	70	67	56	62	76
	Wylot	43	59	64	67	70	65	59	51	73
	Emitowany	39	58	60	61	63	59	53	46	68
4	Wlot	45	45	71	73	70	69	65	58	77
	Wylot	50	44	69	70	67	73	61	53	76
	Emitowany	41	38	62	63	63	60	56	47	68
5	Wlot	41	41	67	69	67	65	60	53	74
	Wylot	43	40	64	66	63	69	55	48	72
	Emitowany	36	34	58	59	59	56	50	42	65
6	Wlot	41	39	64	66	66	64	59	51	72
	Wylot	42	39	61	63	62	67	56	48	70
	Emitowany	36	32	55	56	59	54	49	41	63
7	Wlot	43	61	66	68	66	65	62	51	73
	Wylot	47	60	63	65	67	62	57	45	72
	Emitowany	41	55	58	60	60	57	54	42	66
8	Wlot	36	55	59	61	59	58	54	41	66
	Wylot	38	55	57	59	61	56	48	38	65
	Emitowany	34	50	51	52	53	50	46	32	59
9	Wlot	34	51	55	57	58	56	51	42	63
	Wylot	36	53	52	56	59	55	47	38	63
	Emitowany	32	46	48	49	52	48	44	34	56
10	Wlot	33	50	53	56	54	56	44	35	61
	Wylot	36	50	50	51	56	49	40	33	59
	Emitowany	33	45	45	49	48	49	36	26	54
11	Wlot	26	46	48	50	49	49	38	31	56
	Wylot	30	47	47	48	52	45	36	29	55
	Emitowany	25	41	40	43	43	41	30	23	49
12	Wlot	25	45	45	47	47	47	33	38	53
	Wylot	28	45	45	48	52	46	37	30	55
	Emitowany	25	40	37	40	41	39	30	25	47

● - punkt najwyższej sprawności wentylatora.

CHARAKTERYSTYKI PRACY I CHARAKTERYSTYKI AKUSTYCZNE

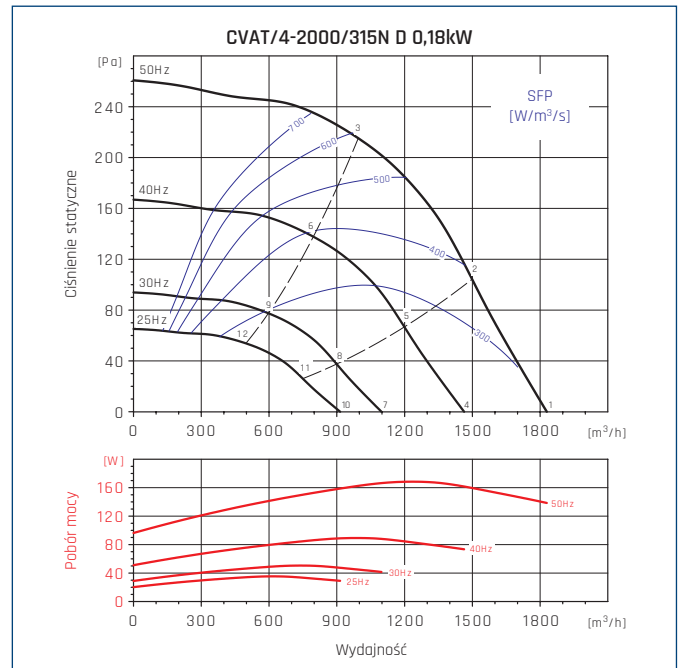
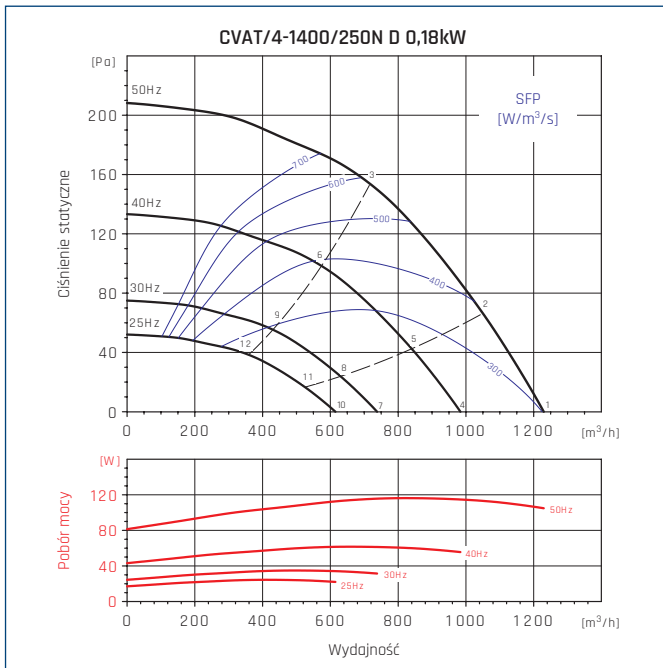

Częst. Hz/dB(A)		63	125	250	500	1000	2000	4000	8000	L _{WA}
1	Wlot	32	55	59	62	58	57	54	51	66
	Wylot	34	50	56	56	59	57	47	42	64
	Emitowany	28	44	45	48	47	45	36	30	53
2	Wlot	34	54	57	61	58	54	52	47	65
	Wylot	34	49	55	55	60	54	46	37	63
	Emitowany	29	42	43	47	47	42	34	24	52
3	Wlot	37	53	58	62	59	54	52	46	65
	Wylot	39	49	56	57	56	54	49	40	63
	Emitowany	31	41	43	48	48	44	35	25	53
4	Wlot	27	50	54	57	53	52	49	46	61
	Wylot	29	46	51	51	54	52	42	38	59
	Emitowany	23	39	40	43	43	40	31	25	48
5	Wlot	29	49	52	56	53	49	47	42	60
	Wylot	29	44	50	50	55	49	41	32	58
	Emitowany	24	38	38	42	42	37	30	19	47
6	Wlot	32	49	53	57	54	49	47	41	61
	Wylot	34	44	51	53	51	50	45	36	58
	Emitowany	26	37	38	43	43	39	30	20	48
7	Wlot	21	44	48	51	47	46	43	40	55
	Wylot	23	39	45	45	48	46	36	31	52
	Emitowany	17	33	33	37	36	34	25	18	42
8	Wlot	23	43	46	50	47	43	41	36	54
	Wylot	23	38	44	44	49	43	35	26	52
	Emitowany	18	31	32	36	35	31	23	13	41
9	Wlot	26	42	46	51	48	43	41	35	54
	Wylot	27	38	45	46	45	43	38	29	51
	Emitowany	20	30	31	37	37	33	24	14	41
10	Wlot	17	40	44	47	43	42	39	36	51
	Wylot	19	35	41	41	44	42	32	27	48
	Emitowany	13	29	30	33	32	30	21	15	38
11	Wlot	19	39	42	46	43	39	37	32	50
	Wylot	19	34	40	40	45	39	31	22	48
	Emitowany	14	27	28	32	32	27	19	9	37
12	Wlot	22	38	42	47	44	39	37	31	50
	Wylot	23	34	41	42	41	39	34	25	47
	Emitowany	16	26	27	33	33	29	20	10	38

Częst. Hz/dB(A)		63	125	250	500	1000	2000	4000	8000	L _{WA}
1	Wlot	37	60	63	66	63	62	58	54	71
	Wylot	40	56	61	61	64	62	52	47	69
	Emitowany	33	48	49	52	51	49	40	33	57
2	Wlot	38	59	62	64	62	58	56	51	69
	Wylot	39	54	60	59	64	58	50	41	67
	Emitowany	33	47	48	50	50	45	38	28	55
3	Wlot	40	57	61	64	61	57	55	49	68
	Wylot	42	53	59	61	59	57	52	43	66
	Emitowany	35	45	46	50	50	46	37	28	55
4	Wlot	32	55	58	61	58	58	53	50	66
	Wylot	35	51	56	56	59	57	47	42	64
	Emitowany	28	43	45	47	46	44	35	29	52
5	Wlot	33	54	57	60	57	53	51	46	64
	Wylot	34	49	55	54	59	53	46	37	63
	Emitowany	28	42	43	45	45	40	33	23	51
6	Wlot	35	52	56	59	57	52	50	44	63
	Wylot	37	49	54	56	54	52	47	39	61
	Emitowany	30	40	42	45	45	41	32	23	50
7	Wlot	26	49	52	55	51	51	47	43	59
	Wylot	29	45	50	50	53	50	41	36	57
	Emitowany	22	37	38	41	40	38	29	22	46
8	Wlot	27	48	51	53	50	47	45	40	58
	Wylot	28	43	49	48	53	47	39	30	56
	Emitowany	22	36	37	39	39	34	27	17	44
9	Wlot	29	46	50	53	50	46	44	38	57
	Wylot	31	42	48	50	48	46	41	32	55
	Emitowany	24	34	35	39	39	35	26	17	44
10	Wlot	22	45	48	51	47	47	43	39	56
	Wylot	25	41	46	46	49	47	37	32	54
	Emitowany	18	33	34	37	36	34	25	18	42
11	Wlot	23	44	47	49	47	43	41	36	54
	Wylot	24	39	45	44	49	43	35	26	52
	Emitowany	18	32	33	35	35	30	23	13	40
12	Wlot	25	42	46	49	46	42	40	34	53
	Wylot	27	38	44	46	44	42	37	28	51
	Emitowany	20	30	31	35	35	31	22	13	40

● - punkt najwyższej sprawności wentylatora.

CHARAKTERYSTYKI PRACY I CHARAKTERYSTYKI AKUSTYCZNE

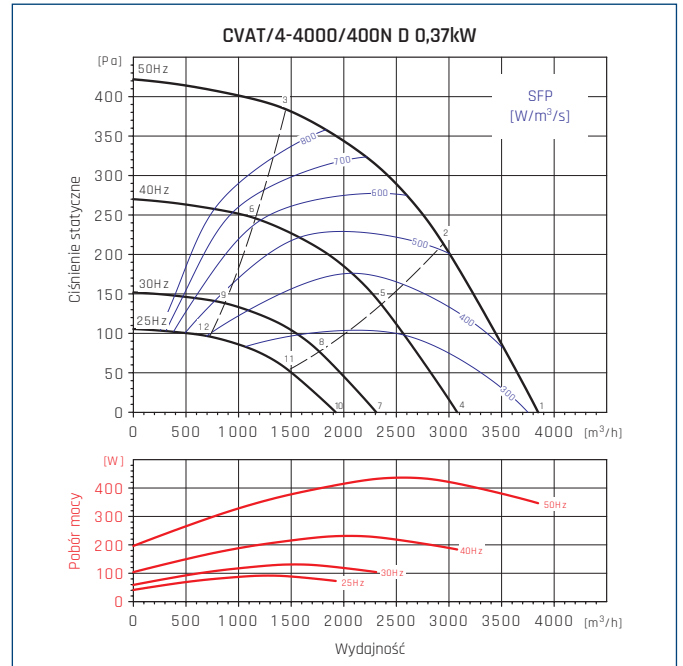
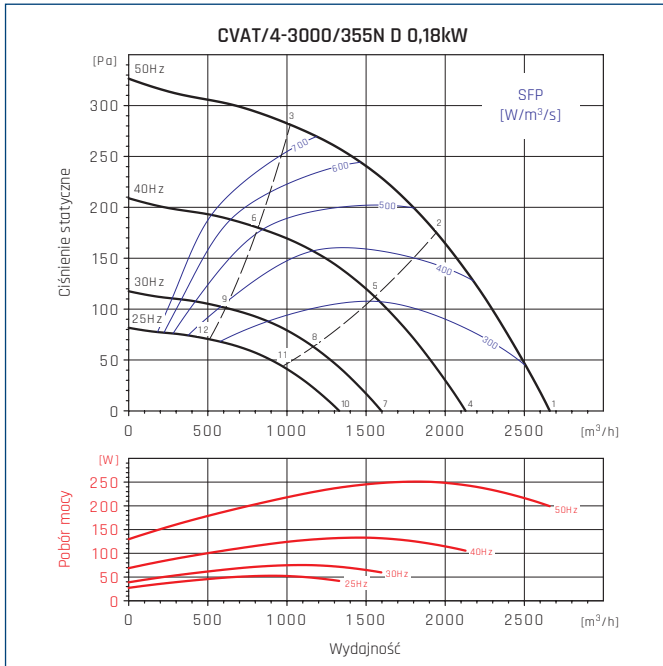

Częst. Hz/dB(A)		63	125	250	500	1000	2000	4000	8000	L _{WA}
1	Wlot	41	64	67	69	66	67	61	57	74
	Wylot	45	61	65	66	68	66	57	50	73
	Emitowany	37	52	54	55	54	53	43	37	61
2	Wlot	40	61	64	66	64	61	57	52	71
	Wylot	42	58	63	62	67	60	53	44	70
	Emitowany	35	50	51	52	52	47	40	31	58
3	Wlot	41	58	61	63	61	57	55	49	68
	Wylot	43	55	59	61	59	57	51	44	66
	Emitowany	36	47	48	50	50	46	38	29	56
4	Wlot	37	59	62	64	61	62	56	53	69
	Wylot	40	56	61	61	63	61	52	45	68
	Emitowany	32	47	49	50	49	48	39	32	56
5	Wlot	35	57	59	61	59	56	53	48	66
	Wylot	38	53	58	57	62	55	48	39	65
	Emitowany	30	45	46	47	47	42	35	26	53
6	Wlot	36	53	56	58	56	53	50	44	63
	Wylot	38	50	54	56	54	52	47	39	61
	Emitowany	31	42	43	45	45	41	33	24	51
7	Wlot	30	53	56	58	55	56	50	46	63
	Wylot	34	50	54	55	57	55	46	39	62
	Emitowany	26	41	43	44	43	42	32	25	50
8	Wlot	29	50	53	55	53	50	46	41	60
	Wylot	31	47	52	51	56	49	42	33	59
	Emitowany	24	39	40	41	40	36	29	20	47
9	Wlot	30	47	50	52	50	46	43	38	57
	Wylot	32	44	48	50	48	46	40	32	55
	Emitowany	25	36	37	39	39	35	27	18	45
10	Wlot	26	49	52	54	51	52	46	42	59
	Wylot	30	46	50	51	53	51	42	35	58
	Emitowany	22	37	39	40	39	38	28	22	46
11	Wlot	25	46	49	51	49	46	42	37	56
	Wylot	27	43	48	47	52	45	38	29	55
	Emitowany	20	35	36	37	37	32	25	16	43
12	Wlot	26	43	46	48	46	42	39	34	53
	Wylot	28	40	44	46	44	42	36	28	51
	Emitowany	21	32	33	35	35	31	23	14	41

Częst. Hz/dB(A)		63	125	250	500	1000	2000	4000	8000	L _{WA}
1	Wlot	45	67	70	71	68	70	64	59	77
	Wylot	50	65	68	69	71	69	60	52	76
	Emitowany	40	55	57	57	56	55	46	39	63
2	Wlot	43	65	68	69	67	65	61	56	74
	Wylot	47	63	68	66	71	64	57	49	74
	Emitowany	38	54	55	55	54	50	43	34	61
3	Wlot	44	62	65	66	64	61	57	52	71
	Wylot	47	59	62	65	62	60	54	47	69
	Emitowany	40	51	52	52	52	48	40	32	59
4	Wlot	40	62	65	66	64	65	59	55	72
	Wylot	45	61	64	65	66	64	55	48	71
	Emitowany	35	50	52	52	51	50	41	34	58
5	Wlot	38	61	63	64	62	60	56	51	70
	Wylot	42	58	63	61	66	59	52	44	69
	Emitowany	33	49	51	50	49	45	38	29	56
6	Wlot	39	57	60	61	59	56	52	47	66
	Wylot	42	54	57	60	57	55	49	42	64
	Emitowany	35	46	48	48	47	43	36	28	54
7	Wlot	33	56	59	60	57	59	53	48	66
	Wylot	39	54	57	58	60	58	49	41	65
	Emitowany	29	44	46	46	45	44	35	28	52
8	Wlot	32	54	57	58	56	54	49	44	63
	Wylot	36	52	57	55	60	53	46	37	63
	Emitowany	27	43	44	44	43	39	32	23	50
9	Wlot	33	51	53	55	53	50	46	41	60
	Wylot	36	48	51	54	51	49	43	36	58
	Emitowany	28	40	41	41	41	37	29	21	48
10	Wlot	29	52	55	56	53	55	49	44	62
	Wylot	35	50	53	54	56	54	45	37	61
	Emitowany	25	40	42	42	41	40	31	24	48
11	Wlot	28	50	53	54	52	50	46	41	59
	Wylot	32	48	53	51	56	49	42	34	59
	Emitowany	23	39	40	40	39	35	28	19	46
12	Wlot	29	47	50	51	49	46	42	37	56
	Wylot	32	44	47	50	47	45	39	32	54
	Emitowany	25	36	37	37	37	33	25	17	44

● - punkt najwyższej sprawności wentylatora.

CHARAKTERYSTYKI PRACY I CHARAKTERYSTYKI AKUSTYCZNE

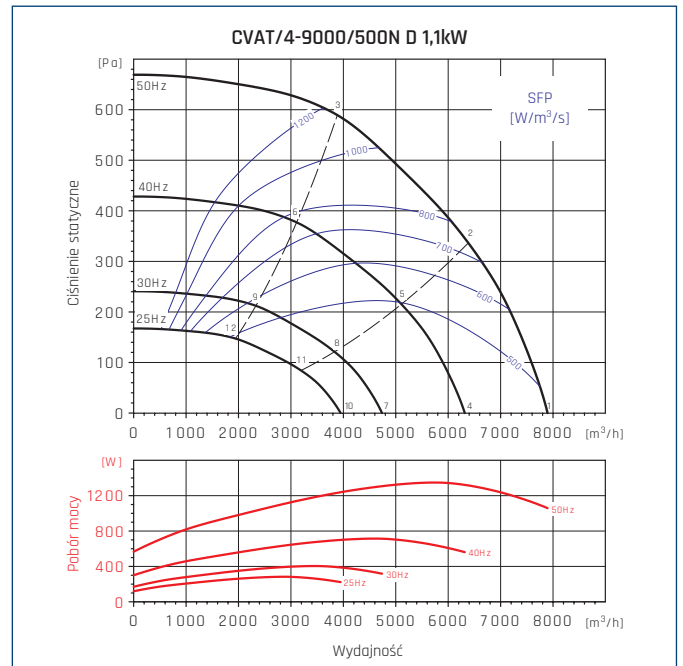
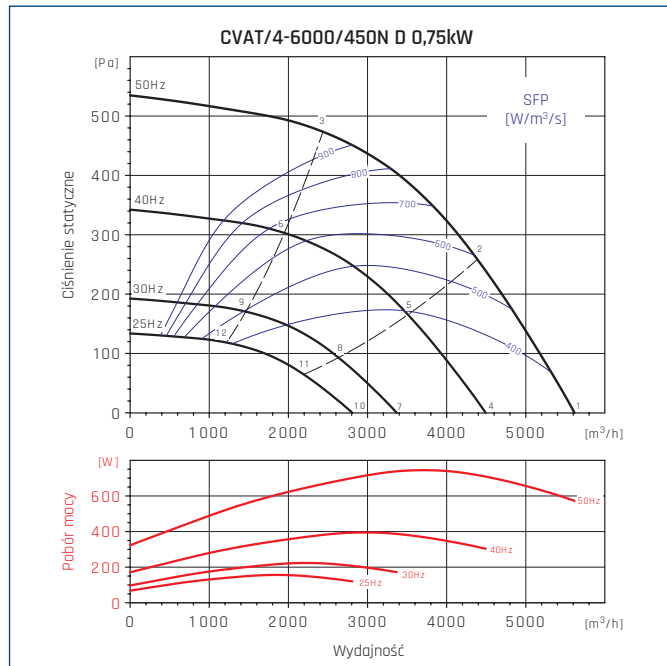

Częst. Hz/dB(A)		63	125	250	500	1000	2000	4000	8000	L _{WA}
1	Wlot	48	71	73	74	71	74	67	62	80
	Wylot	55	70	72	74	75	72	64	55	80
	Emitowany	43	59	61	59	58	58	49	41	66
2	Wlot	46	69	72	72	70	69	64	59	78
	Wylot	52	68	72	70	75	67	60	53	78
	Emitowany	41	58	60	58	57	53	46	38	65
3	Wlot	49	68	69	70	68	66	61	57	75
	Wylot	52	65	67	70	67	64	59	52	75
	Emitowany	44	57	58	56	55	51	44	37	63
4	Wlot	43	66	69	69	67	69	62	57	75
	Wylot	50	65	67	69	70	68	59	51	75
	Emitowany	38	54	56	55	54	54	44	37	62
5	Wlot	41	64	67	67	65	64	59	54	73
	Wylot	47	63	67	65	70	62	56	48	74
	Emitowany	36	53	55	53	52	48	41	33	60
6	Wlot	44	63	65	65	63	61	57	52	71
	Wylot	48	61	62	66	62	60	54	47	70
	Emitowany	40	52	53	51	51	46	39	32	58
7	Wlot	37	60	62	63	60	63	56	51	69
	Wylot	44	59	61	62	64	61	53	44	69
	Emitowany	32	48	50	48	47	47	38	30	55
8	Wlot	35	58	61	61	59	57	52	47	67
	Wylot	41	57	61	59	64	56	49	42	67
	Emitowany	30	46	49	47	46	42	35	27	53
9	Wlot	38	57	58	58	57	54	50	46	64
	Wylot	41	54	56	59	56	53	47	41	64
	Emitowany	33	46	47	45	44	40	33	26	52
10	Wlot	33	56	58	59	56	59	52	47	65
	Wylot	40	55	57	58	60	57	49	40	65
	Emitowany	28	44	46	44	43	43	34	26	51
11	Wlot	31	54	57	57	55	54	48	43	63
	Wylot	37	53	57	55	60	52	45	38	63
	Emitowany	26	43	45	43	42	38	31	23	50
12	Wlot	34	53	54	54	53	50	46	42	60
	Wylot	37	50	52	55	52	49	43	37	60
	Emitowany	29	42	43	41	40	36	29	22	48

Częst. Hz/dB(A)		63	125	250	500	1000	2000	4000	8000	L _{WA}
1	Wlot	51	73	75	75	73	77	68	63	82
	Wylot	58	73	74	76	77	75	67	57	83
	Emitowany	46	61	63	61	60	60	50	43	68
2	Wlot	48	73	75	75	73	72	66	61	81
	Wylot	56	72	77	74	78	71	64	57	82
	Emitowany	43	61	64	61	59	56	49	41	68
3	Wlot	54	73	74	73	72	70	65	61	80
	Wylot	58	71	72	75	72	69	62	56	79
	Emitowany	49	62	63	59	58	54	48	41	67
4	Wlot	46	68	71	70	68	72	64	58	77
	Wylot	53	68	70	71	72	70	62	52	78
	Emitowany	41	56	59	56	55	55	45	38	63
5	Wlot	44	68	71	70	68	67	61	56	76
	Wylot	52	67	72	69	74	66	59	52	77
	Emitowany	39	56	59	56	55	51	44	36	63
6	Wlot	49	68	69	68	67	65	60	56	75
	Wylot	53	66	67	70	67	64	58	51	74
	Emitowany	44	57	58	54	54	49	43	36	62
7	Wlot	40	62	64	64	62	66	57	52	71
	Wylot	47	62	63	65	66	64	56	46	71
	Emitowany	35	50	52	50	49	49	39	32	57
8	Wlot	37	62	64	64	62	61	55	50	70
	Wylot	45	61	65	63	67	60	53	46	71
	Emitowany	32	50	53	50	48	44	37	30	57
9	Wlot	42	61	63	62	60	59	54	50	68
	Wylot	46	60	61	64	61	57	51	45	68
	Emitowany	38	50	52	48	47	43	37	30	56
10	Wlot	36	58	60	60	58	62	53	48	67
	Wylot	43	58	59	61	62	60	52	42	68
	Emitowany	31	46	48	46	45	45	35	28	53
11	Wlot	33	58	60	60	58	57	51	46	66
	Wylot	41	57	62	59	63	56	49	42	67
	Emitowany	28	46	49	46	44	40	33	26	53
12	Wlot	39	57	59	58	56	55	50	46	64
	Wylot	42	56	57	60	57	53	47	41	64
	Emitowany	34	47	48	44	43	39	33	26	52

● - punkt najwyższej sprawności wentylatora.

CHARAKTERYSTYKI PRACY I CHARAKTERYSTYKI AKUSTYCZNE

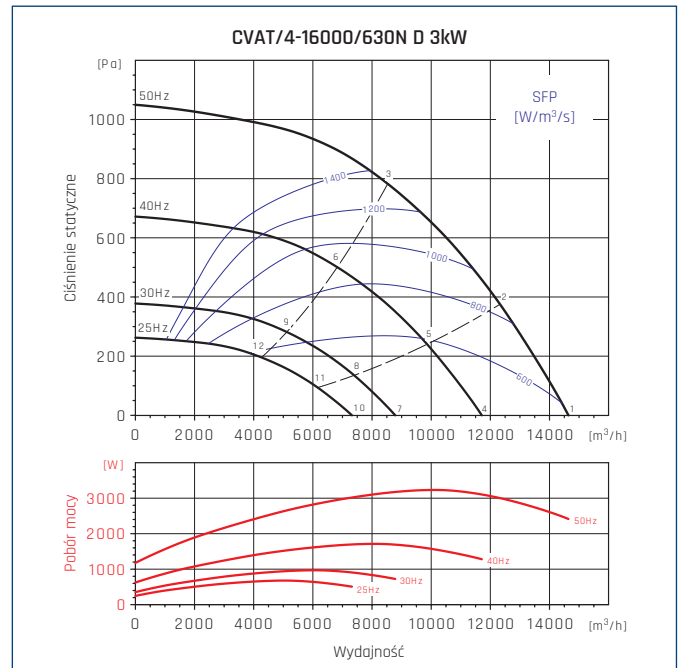
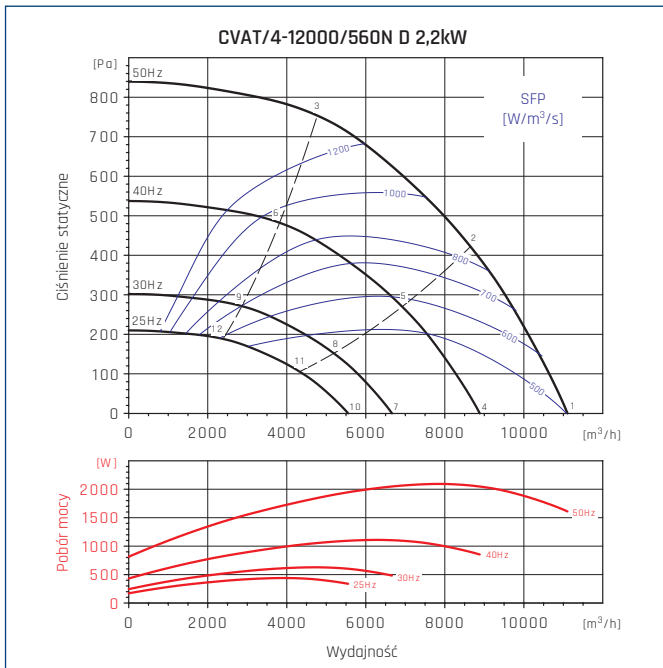

Częst. Hz/dB(A)		63	125	250	500	1000	2000	4000	8000	L _{WA}
1	Wlot	55	77	79	78	76	81	72	66	86
	Wylot	63	78	78	81	81	78	71	60	87
	Emitowany	49	64	67	64	62	63	53	46	72
2	Wlot	51	76	78	77	76	75	69	64	84
	Wylot	60	76	80	77	81	73	67	60	85
	Emitowany	46	64	67	63	61	58	51	44	71
3	Wlot	56	75	76	74	73	72	67	63	81
	Wylot	60	74	74	78	74	70	64	58	81
	Emitowany	51	65	66	61	60	55	49	43	70
4	Wlot	50	72	74	73	71	76	67	61	81
	Wylot	58	73	73	76	76	74	66	55	82
	Emitowany	44	60	63	59	58	59	49	41	67
5	Wlot	46	71	73	72	71	70	64	59	79
	Wylot	55	71	75	72	76	68	62	55	81
	Emitowany	41	59	62	58	57	53	46	39	66
6	Wlot	51	70	71	69	68	67	62	58	77
	Wylot	55	69	69	73	69	65	59	53	77
	Emitowany	46	60	61	56	55	50	45	39	65
7	Wlot	44	66	68	67	65	70	61	55	75
	Wylot	52	67	67	69	70	67	60	49	76
	Emitowany	38	53	56	52	51	52	42	35	61
8	Wlot	39	65	67	66	64	64	57	52	73
	Wylot	49	65	69	66	70	62	56	49	74
	Emitowany	34	53	56	52	50	47	40	33	60
9	Wlot	45	64	65	63	62	61	56	52	70
	Wylot	49	63	62	66	62	59	53	47	70
	Emitowany	40	53	55	49	49	44	38	32	59
10	Wlot	40	62	64	63	61	66	57	51	71
	Wylot	48	63	63	65	66	63	56	45	72
	Emitowany	34	49	52	49	47	48	38	31	57
11	Wlot	36	61	63	62	61	60	53	48	69
	Wylot	45	61	65	62	66	58	52	45	70
	Emitowany	31	49	52	48	46	43	36	29	56
12	Wlot	41	60	61	59	58	57	52	48	66
	Wylot	45	59	59	62	59	55	49	43	66
	Emitowany	36	49	51	45	45	40	34	28	55

Częst. Hz/dB(A)		63	125	250	500	1000	2000	4000	8000	L _{WA}
1	Wlot	57	79	81	80	78	84	74	68	88
	Wylot	67	82	81	84	84	81	74	62	90
	Emitowany	52	67	70	65	64	66	56	48	74
2	Wlot	53	79	82	80	78	78	71	66	87
	Wylot	64	81	84	81	85	76	70	64	89
	Emitowany	48	68	71	66	64	60	53	47	74
3	Wlot	61	81	81	78	78	77	71	68	87
	Wylot	66	81	79	84	79	75	69	64	88
	Emitowany	56	70	71	65	64	59	54	48	75
4	Wlot	53	75	77	75	74	79	69	63	83
	Wylot	62	77	76	79	79	76	69	57	85
	Emitowany	47	62	66	61	59	61	51	43	69
5	Wlot	48	75	77	75	74	74	66	61	82
	Wylot	60	76	79	76	80	72	65	59	84
	Emitowany	43	63	66	61	59	55	48	42	69
6	Wlot	56	76	77	74	73	72	67	63	82
	Wylot	61	76	74	79	74	71	64	59	83
	Emitowany	52	65	67	60	59	54	49	44	70
7	Wlot	46	68	70	69	67	73	63	57	77
	Wylot	56	70	70	73	73	70	63	51	78
	Emitowany	41	56	59	54	53	55	45	37	63
8	Wlot	42	68	71	69	67	67	60	55	76
	Wylot	53	69	73	69	74	65	59	53	78
	Emitowany	37	57	60	54	53	49	42	36	63
9	Wlot	50	70	70	67	67	66	60	57	76
	Wylot	55	70	68	72	68	64	58	53	76
	Emitowany	45	59	60	53	53	48	43	37	64
10	Wlot	42	64	66	65	63	69	59	53	73
	Wylot	52	67	66	69	69	66	59	47	74
	Emitowany	37	52	55	50	49	51	41	33	59
11	Wlot	38	64	67	65	63	63	56	51	72
	Wylot	49	65	69	65	70	61	55	49	74
	Emitowany	33	53	56	50	49	45	38	32	59
12	Wlot	46	66	66	63	63	62	56	53	72
	Wylot	51	66	64	69	64	60	54	49	72
	Emitowany	41	55	56	49	49	44	39	33	60

● - punkt najwyższej sprawności wentylatora.

CHARAKTERYSTYKI PRACY I CHARAKTERYSTYKI AKUSTYCZNE

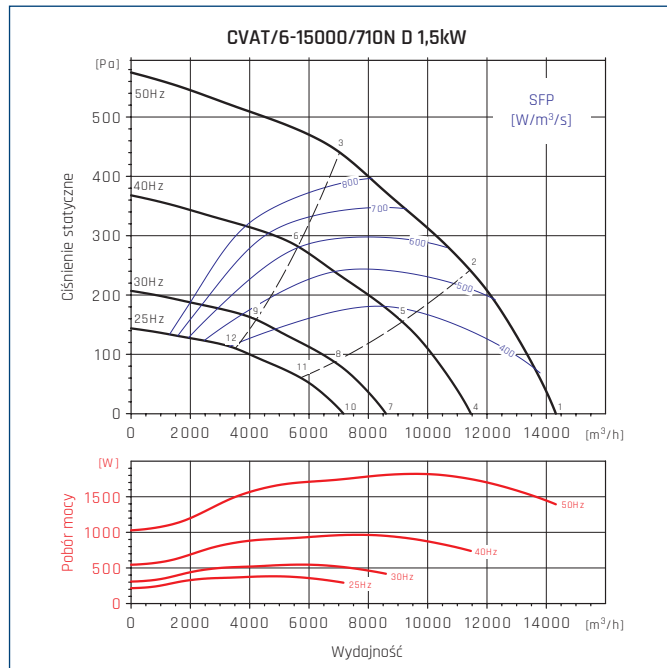

WYMIARY [mm]

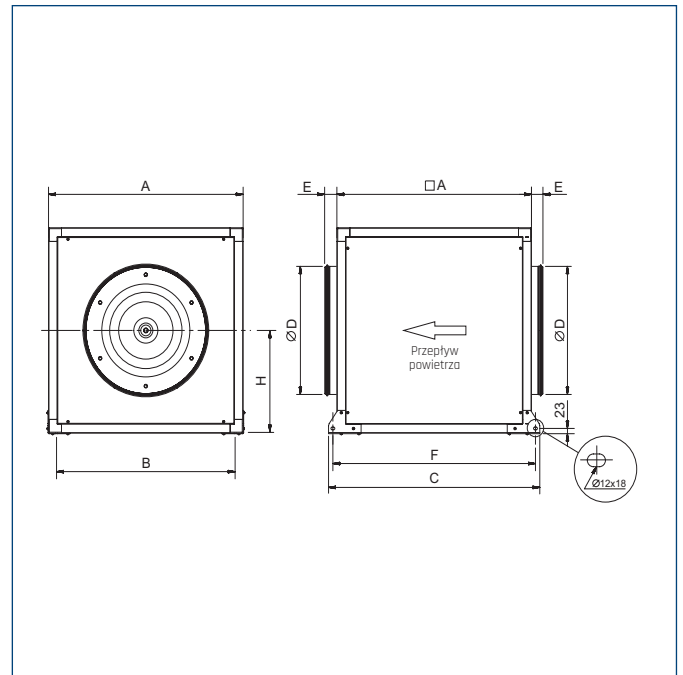

Częst. Hz/dB(A)		63	125	250	500	1000	2000	4000	8000	L _{WA}
1	Wlot	58	80	82	80	78	85	74	67	89
	Wylot	68	83	81	84	84	81	74	62	90
	Emitowany	53	69	72	66	65	67	56	48	75
2	Wlot	52	79	81	79	78	78	70	65	86
	Wylot	64	81	84	80	84	75	69	63	89
	Emitowany	48	68	72	65	63	60	53	47	75
3	Wlot	60	80	80	76	76	76	70	67	85
	Wylot	65	80	77	82	77	73	66	62	86
	Emitowany	56	71	72	63	62	57	53	48	75
4	Wlot	53	75	77	75	74	80	69	63	84
	Wylot	64	78	76	79	79	76	69	57	85
	Emitowany	48	64	67	61	60	62	51	43	71
5	Wlot	47	74	76	74	73	73	65	60	81
	Wylot	59	76	79	75	79	70	64	58	84
	Emitowany	43	63	67	60	58	55	48	43	70
6	Wlot	55	76	75	71	71	71	65	62	80
	Wylot	60	75	72	77	72	68	61	57	81
	Emitowany	51	66	67	58	57	52	48	43	70
7	Wlot	47	69	71	69	67	74	63	56	78
	Wylot	57	72	70	73	73	70	63	50	79
	Emitowany	42	57	61	55	53	56	45	37	64
8	Wlot	41	68	70	67	67	67	59	54	75
	Wylot	53	69	73	69	73	64	58	52	78
	Emitowany	37	57	61	54	52	49	42	36	64
9	Wlot	49	69	69	65	64	65	58	56	74
	Wylot	54	69	66	71	66	62	55	51	75
	Emitowany	45	60	61	52	51	46	42	37	64
10	Wlot	43	65	67	65	63	70	59	52	74
	Wylot	53	68	66	69	69	66	59	47	75
	Emitowany	38	53	57	51	50	52	41	33	60
11	Wlot	37	64	66	64	63	63	55	50	71
	Wylot	49	66	69	65	69	60	54	48	74
	Emitowany	33	53	57	50	48	45	38	32	60
12	Wlot	45	65	65	61	61	61	54	52	70
	Wylot	50	65	62	67	62	58	51	47	71
	Emitowany	41	56	57	48	47	42	38	33	60

Typ CVAB/CVAT	A	B	C	D	E	F	H
1400/250N D	500	457	574	250	58	534	250
2000/315N D	500	457	574	315	58	534	250
3000/355N D	650	607	724	355	58	684	325
4000/400N D	650	607	724	400	58	684	325
6000/450N D	750	707	824	450	58	784	375
9000/500N D	800	757	824	500	58	834	400
12000/560N D	900	826	977	560	58	937	450
16000/630N D	1000	959	1077	630	58	1037	500
15000/710N D	1100	1059	1177	710	58	1137	550

● - punkt najwyższej sprawności wentylatora.

Alternatywa montażu

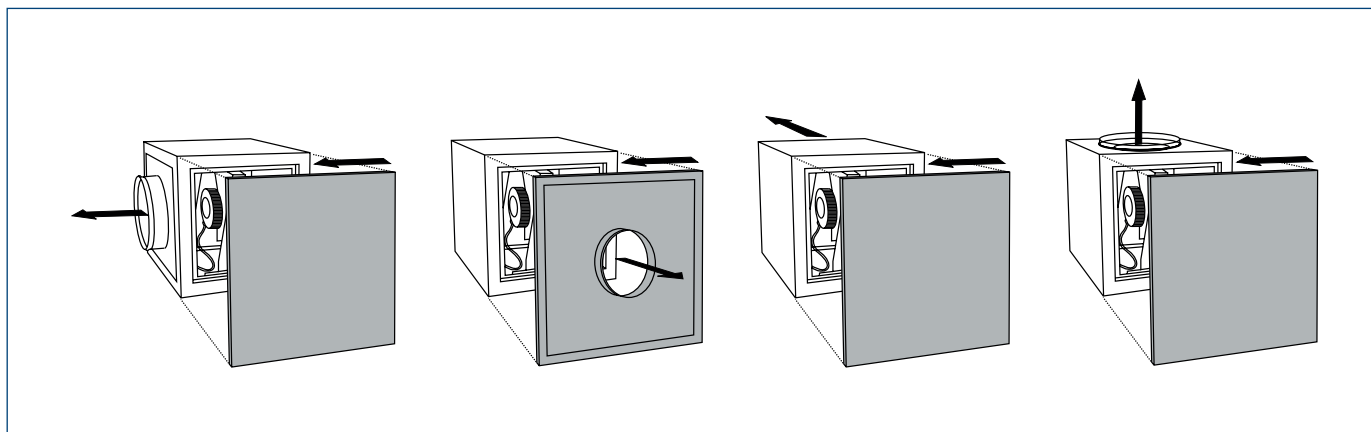

AKCESORIA MONTAŻOWE

Wentylator	filtr kanałowy DF	filtr kanałowy DF-K				złącze przeciwdrganiowe ACOP	klapa zwrotna CAR-PL	przepust. soczewk. IRIS	osłona CTI CVA-N
		wkład filtracyjny do DF-K							
		EU3	EU5	EU7					
CVAB/4-1400/250N D	DF 250	DF-K 250	EU3 100-250mm	EU5 100-250mm	EU7 100-250mm	ACOP PL 250	CAR-PL 250	IRIS 250	CTI CVA-N 250/315
CVAB/4-2000/315N D	DF 315	DF-K 315	EU3 315-450mm	EU5 315-450mm	EU7 315-450mm	ACOP PL 315	CAR-PL 315	IRIS 315	CTI CVA-N 250/315
CVAB/4-3000/355N D	DF 355	DF-K 355	EU3 315-450mm	EU5 315-450mm	EU7 315-450mm	ACOP PL 355	CAR-PL 355	-	CTI CVA-355/400
CVAB/4-4000/400N D	DF 400	DF-K 400	EU3 315-450mm	EU5 315-450mm	EU7 315-450mm	ACOP PL 400	CAR-PL 400	IRIS 400	CTI CVA-355/400
CVAB/4-6000/450N D	-	DF-K 450	EU3 315-450mm	EU5 315-450mm	EU7 315-450mm	-	-	-	CTI CVA-N 450
CVAB/4-9000/500N D	-	DF-K 500	-	-	-	-	-	-	CTI CVA-500
CVAT/4-1400/250N D 0,18	DF 250	DF-K 250	EU3 100-250mm	EU5 100-250mm	EU7 100-250mm	ACOP PL 250	CAR-PL 250	IRIS 250	CTI CVA-N 250/315
CVAT/4-2000/315N D 0,18	DF 315	DF-K 315	EU3 315-450mm	EU5 315-450mm	EU7 315-450mm	ACOP PL 315	CAR-PL 315	IRIS 315	CTI CVA-N 250/315
CVAT/4-3000/355N D 0,18	DF 355	DF-K 355	EU3 315-450mm	EU5 315-450mm	EU7 315-450mm	ACOP PL 355	CAR-PL 355	-	CTI CVA-355/400
CVAT/4-4000/400N D 0,37	DF 400	DF-K 400	EU3 315-450mm	EU5 315-450mm	EU7 315-450mm	ACOP PL 400	CAR-PL 400	IRIS 400	CTI CVA-355/400
CVAT/4-6000/450N D 0,75	-	DF-K 450	EU3 315-450mm	EU5 315-450mm	EU7 315-450mm	-	-	-	CTI CVA-N 450
CVAT/4-9000/500N D 1,1	-	DF-K 500	-	-	-	-	-	IRIS 500	CTI CVA-500
CVAT/4-12000/560N D 2,2	-	DF-K 560	-	-	-	-	-	-	CTI CVA-N 560
CVAT/4-16000/630N D 3	-	-	-	-	-	-	-	IRIS 630	CTI CVA-N 630
CVAT/6-15000/710N D 1,5	-	-	-	-	-	-	-	-	CTI CVA-N 710

Numery artykułów

ACOP PL 250	40521830	DF 250	40520650	DF-K 450	40521750	EU7 315-450mm	40520840	CTI CVA-N 450	41022482-03
ACOP PL 315	40521835	DF 315	40520660	DF-K 500	40521755	IRIS 250	19527250	CTI CVA-500	41022482-04
ACOP PL 355	40521840	DF 355	40520670	DF-K 560	40521760	IRIS 315	19527315	CTI CVA-N 560	41022482-05
ACOP PL 400	40521845	DF 400	40520675	EU3 100-250mm	40520800	IRIS 400	19527400	CTI CVA-N 630	41022482-06
CAR-PL 250	40521050-01	DF-K 250	40521730	EU3 315-450mm	40520830	IRIS 500	19527500	CTI CVA-N 710	41022482-07
CAR-PL 315	40521060-01	DF-K 315	40521735	EU5 100-250mm	40520805	IRIS 630	19527630		
CAR-PL 355	40521065-01	DF-K 355	40521740	EU5 315-450mm	40520835	CTI CVA-N 250/315	41022482-01		
CAR-PL 400	40521070-01	DF-K 400	40521745	EU7 100-250mm	40520810	CTI CVA-355/400	41022482-02		



AKCESORIA ELEKTRYCZNE

Wentylator	termostat ścienny	termostat kanałowy	czujnik zanieczyszczeń	higrostat	regulator tyrystorowy		
	TS	TK-1	SQA	HIG-2	REB N	REB NE	TLR
CVAB/4-1400/250N D	TS	TK-1	SQA	HIG-2	REB-1 N	REB-1 NE	TLR 15 DS
CVAB/4-2000/315N D	TS	TK-1	SQA	HIG-2	REB-1 N	REB-1 NE	TLR 15 DS
CVAB/4-3000/355N D	TS	TK-1	SQA	HIG-2	REB-2.5 N	REB-2.5 NE	TLR 15 DS
CVAB/4-4000/400N D	TS	TK-1	SQA	HIG-2	REB-2.5 N	REB-2.5 NE	TLR 25 DS
CVAB/4-6000/450N D	TS + DILM 7-10	TK-1 + DILM 7-10	SQA + DILM 7-10	HIG-2 + DILM 7-10	REB-5	-	-
CVAB/4-9000/500N D	TS + DILM 7-10	TK-1 + DILM 7-10	SQA + DILM 7-10	HIG-2 + DILM 7-10	REB-10	-	-
CVAT/4-1400/250N D 0,18	TS + DILM 7-10	TK-1 + DILM 7-10	SQA + DILM 7-10	HIG-2 + DILM 7-10	-	-	-
CVAT/4-2000/315N D 0,18	TS + DILM 7-10	TK-1 + DILM 7-10	SQA + DILM 7-10	HIG-2 + DILM 7-10	-	-	-
CVAT/4-3000/355N D 0,18	TS + DILM 7-10	TK-1 + DILM 7-10	SQA + DILM 7-10	HIG-2 + DILM 7-10	-	-	-
CVAT/4-4000/400N D 0,37	TS + DILM 7-10	TK-1 + DILM 7-10	SQA + DILM 7-10	HIG-2 + DILM 7-10	-	-	-
CVAT/4-6000/450N D 0,75	TS + DILM 7-10	TK-1 + DILM 7-10	SQA + DILM 7-10	HIG-2 + DILM 7-10	-	-	-
CVAT/4-9000/500N D 1,1	TS + DILM 7-10	TK-1 + DILM 7-10	SQA + DILM 7-10	HIG-2 + DILM 7-10	-	-	-
CVAT/4-12000/560N D 2,2	TS + DILM 7-10	TK-1 + DILM 7-10	SQA + DILM 7-10	HIG-2 + DILM 7-10	-	-	-
CVAT/4-16000/630N D 3	TS + DILM 7-10	TK-1 + DILM 7-10	SQA + DILM 7-10	HIG-2 + DILM 7-10	-	-	-
CVAT/6-15000/710N D 1,5	TS + DILM 7-10	TK-1 + DILM 7-10	SQA + DILM 7-10	HIG-2 + DILM 7-10	-	-	-

Wentylator	11-stopniowy regulator tyrystorowy	2-nastawowy 6-biegowy regulator tyrystorowy	ERV	regulator transformatorowy		regulator transformatorowy 2-nastawowy		falownik
				RMB	RVS	SC2	SC2A	
CVAB/4-1400/250N D	IRF-900	RND-1	ERV-3	RMB-1.5	RVS-1.5	SC2-1-15L25	SC2A1-15L25	-
CVAB/4-2000/315N D	IRF-900	RND-1	ERV-3	RMB-1.5	RVS-1.5	SC2-1-15L25	SC2A1-15L25	-
CVAB/4-3000/355N D	IRF-900	RND-1	ERV-3	RMB-1.5	RVS-1.5	SC2-1-15L25	SC2A1-15L25	-
CVAB/4-4000/400N D	IRF-900	RND-1	ERV-3	RMB-3.5	RVS-3	SC2-1-25L25	SC2A1-25L25	-
CVAB/4-6000/450N D	-	-	ERV-5	RMB-8	RVS-5	SC2-1-50L25	SC2A1-50L25	-
CVAB/4-9000/500N D	-	-	ERV-10	RMB-8	RVS-7	SC2-1-75L25	SC2A1-75L25	-
CVAT/4-1400/250N D 0,18	-	-	-	-	-	-	-	L 0.75kW
CVAT/4-2000/315N D 0,18	-	-	-	-	-	-	-	L 0.75kW
CVAT/4-3000/355N D 0,18	-	-	-	-	-	-	-	L 0.75kW
CVAT/4-4000/400N D 0,37	-	-	-	-	-	-	-	L 0.75kW
CVAT/4-6000/450N D 0,75	-	-	-	-	-	-	-	L 0.75kW
CVAT/4-9000/500N D 1,1	-	-	-	-	-	-	-	L 1.5kW
CVAT/4-12000/560N D 2,2	-	-	-	-	-	-	-	L 2.2kW
CVAT/4-16000/630N D 3	-	-	-	-	-	-	-	L 4.0kW
CVAT/6-15000/710N D 1,5	-	-	-	-	-	-	-	L 2.2kW

Numery artykułów

DILM 7-10	91040997	L 2.2kW	40016332	RMB-1.5	40025060	SC2-1-15L25	40025250	SQA	40025140
ERV-10	40025054	L 4.0kW	40016352	RMB-3.5	40025070	SC2-1-25L25	40025252	TK-1	40025330
ERV-3	40025046	REB-1 N	40025010	RMB-8	40025080	SC2-1-50L25	40025256	TLR 15 DS	40025025
ERV-5	40025053	REB-1 NE	40025020	RND-1	40025630	SC2-1-75L25	40025258	TLR 25 DS	40025045
HIG-2	40025150	REB-10	40025055	RVS-1.5	40025232	SC2A1-15L25	40025251	TS	40025345
IRF-900	40015154	REB-2.5 N	40025030	RVS-3	40025234	SC2A1-25L25	40025253		
L 0.75kW	40015312	REB-2.5 NE	40025040	RVS-5	40025235	SC2A1-50L25	40025257		
L 1.5kW	40016322	REB-5	40025051	RVS-7	40025236	SC2A1-75L25	40025259		



CHARAKTERYSTYKA ERP

SWNM*								
	Nazwa produktu	CVAB/4-1400/250N D	CVAB/4-2000/315N D	CVAB/4-3000/355N D	CVAB/4-4000/400N D	CVAB/4-9000/500N D	CVAT/4-1400/250N D	CVAT/4-2000/315N D
a	Nazwa dostawcy	VENTURE INDUSTRIES	VENTURE INDUSTRIES	VENTURE INDUSTRIES	VENTURE INDUSTRIES	VENTURE INDUSTRIES	VENTURE INDUSTRIES	VENTURE INDUSTRIES
b	Numer artykułu	41020325	41020335	41020345	41020355	41020370	41020525	41020535
c	Kategoria urządzenia	SWNM (NRVU)	SWNM (NRVU)	SWNM (NRVU)	SWNM (NRVU)	SWNM (NRVU)	SWNM (NRVU)	SWNM (NRVU)
c	Typ urządzenia	JSW (UVU)	JSW (UVU)	JSW (UVU)	JSW (UVU)	JSW (UVU)	JSW (UVU)	JSW (UVU)
d	Napęd	bezstopniowy	bezstopniowy	bezstopniowy	bezstopniowy	bezstopniowy	bezstopniowy	bezstopniowy
e	Typ odzysku ciepła	brak	brak	brak	brak	brak	brak	brak
f	Sprawność temperaturowa [%]	nie dotyczy	nie dotyczy	nie dotyczy	nie dotyczy	nie dotyczy	nie dotyczy	nie dotyczy
g	Znamionowe natężenie przepływu w SWNM [m³/s]	0,25	0,29	0,49	0,75	1,28	0,23	0,34
h	Efektywny pobór mocy [kW]	0,11	0,17	0,31	0,56	1,28	0,12	0,17
i	JMWint [W/(m³/s)]	nie dotyczy	nie dotyczy	nie dotyczy	nie dotyczy	nie dotyczy	nie dotyczy	nie dotyczy
j	Prędkość czotowa [m/s]	1,3	1,5	1,4	2,2	2,3	1,2	1,8
k	$\Delta p_{s, ext}$ [Pa]	116	215	238	288	461	134	183
l	$\Delta p_{s, int}$ [Pa]	nie dotyczy	nie dotyczy	nie dotyczy	nie dotyczy	nie dotyczy	nie dotyczy	nie dotyczy
m	$\Delta p_{s, add}$ [Pa]	nie dotyczy	nie dotyczy	nie dotyczy	nie dotyczy	nie dotyczy	nie dotyczy	nie dotyczy
n	sprawność statyczna wentylatora [%]	40,7	44,9	46,2	50,1	52,7	38,9	39,4
o	Stopień zewnętrznych przecieków powietrza [%]	5	5	5	5	5	5	5
p	Stopień wewnętrznych przecieków powietrza [%]	nie dotyczy	nie dotyczy	nie dotyczy	nie dotyczy	nie dotyczy	nie dotyczy	nie dotyczy
q	efektywność energetyczna filtra	nie dotyczy	nie dotyczy	nie dotyczy	nie dotyczy	nie dotyczy	nie dotyczy	nie dotyczy
r	Ostrzeżenia o konieczności wymiany filtra	nie dotyczy	nie dotyczy	nie dotyczy	nie dotyczy	nie dotyczy	nie dotyczy	nie dotyczy
s	L_{wa} [dB(A)]	59	61	65	68	75	53	55
	Strona internetowa	venture.pl solerpalau.com	venture.pl solerpalau.com	venture.pl solerpalau.com	venture.pl solerpalau.com	venture.pl solerpalau.com	venture.pl solerpalau.com	venture.pl solerpalau.com

	Nazwa produktu	CVAT/4-3000/355N D	CVAT/4-4000/400N D	CVAT/4-6000/450N D	CVAT/4-9000/500N D	CVA/4-12000/560N D	CVAT/4-16000/630N D	CVAT/6-15000/710N D
a	Nazwa dostawcy	VENTURE INDUSTRIES	VENTURE INDUSTRIES	VENTURE INDUSTRIES	VENTURE INDUSTRIES	VENTURE INDUSTRIES	VENTURE INDUSTRIES	VENTURE INDUSTRIES
b	Numer artykułu	41020545	41020555	41020565	41020575	41020595	41020607	41020605
c	Kategoria urządzenia	SWNM (NRVU)	SWNM (NRVU)	SWNM (NRVU)	SWNM (NRVU)	SWNM (NRVU)	SWNM (NRVU)	SWNM (NRVU)
c	Typ urządzenia	JSW (UVU)	JSW (UVU)	JSW (UVU)	JSW (UVU)	JSW (UVU)	JSW (UVU)	JSW (UVU)
d	Napęd	bezstopniowy	bezstopniowy	bezstopniowy	bezstopniowy	bezstopniowy	bezstopniowy	bezstopniowy
e	Typ odzysku ciepła	brak	brak	brak	brak	brak	brak	brak
f	Sprawność temperaturowa [%]	nie dotyczy	nie dotyczy	nie dotyczy	nie dotyczy	nie dotyczy	nie dotyczy	nie dotyczy
g	Znamionowe natężenie przepływu w SWNM [m³/s]	0,49	0,71	1,03	1,66	2,01	2,49	3,08
h	Efektywny pobór mocy [kW]	0,25	0,44	0,75	1,34	2,08	3,19	1,77
i	JMWint [W/(m³/s)]	nie dotyczy	nie dotyczy	nie dotyczy	nie dotyczy	nie dotyczy	nie dotyczy	Nie dotyczy
j	Prędkość czotowa [m/s]	1,4	2	2,2	3	3	2,9	3
k	$\Delta p_{s, ext}$ [Pa]	209	284	367	391	574	749	265
l	$\Delta p_{s, int}$ [Pa]	nie dotyczy	nie dotyczy	nie dotyczy	nie dotyczy	nie dotyczy	nie dotyczy	nie dotyczy
m	$\Delta p_{s, add}$ [Pa]	nie dotyczy	nie dotyczy	nie dotyczy	nie dotyczy	nie dotyczy	nie dotyczy	nie dotyczy
n	sprawność statyczna wentylatora [%]	40	45,6	57,7	58,4	61	61,6	52,4
o	Stopień zewnętrznych przecieków powietrza [%]	5	5	5	5	5	5	5
p	Stopień wewnętrznych przecieków powietrza [%]	nie dotyczy	nie dotyczy	nie dotyczy	nie dotyczy	nie dotyczy	nie dotyczy	nie dotyczy
q	efektywność energetyczna filtra	nie dotyczy	nie dotyczy	nie dotyczy	nie dotyczy	nie dotyczy	nie dotyczy	nie dotyczy
r	Ostrzeżenia o konieczności wymiany filtra	nie dotyczy	nie dotyczy	nie dotyczy	nie dotyczy	nie dotyczy	nie dotyczy	nie dotyczy
s	L_{wa} [dB(A)]	58	61	64	68	71	75	69
	Strona internetowa	venture.pl solerpalau.com	venture.pl solerpalau.com	venture.pl solerpalau.com	venture.pl solerpalau.com	venture.pl solerpalau.com	venture.pl solerpalau.com	venture.pl solerpalau.com

* SWNM-"system wentylacyjny przeznaczony do budynków niemieszkalnych"-zgodnie z Rozporządzeniem Komisji (UE) nr 1253/2014