



ZASTOSOWANIE

Wentylatory HCTT EX odpowiadają wymaganiom Dyrektywy ATEX 2014/34/UE, są zaprojektowane do użytku w strefach zagrożenia wybuchem poza kopalniami i wyrobiskami górniczymi. Spełniają wymogi grupy II kategorii 2G/3G - strefa 1 i/lub 2.

Oznaczenie: ATEX II2G Exe II T3 Gb.

KONSTRUKCJA

- wirnik formowany wtryskowo w całości z tworzywa sztucznego wzmocniany włóknem szklanym (w modelach 315-400) lub łopatki z tworzywa sztucznego w odlewanej z aluminium pianie,
- czasza aluminiowa,
- podstawa z blachy stalowej ocynkowanej,
- maksymalna temperatura tłoczonego medium 40°C.

SILNIK ELEKTRYCZNY

- asynchroniczny, trójfazowy, 400 V, 50 Hz,
- stopień ochrony IP55,
- klasa izolacji F,
- zabezpieczenie termiczne (oprócz modeli od 800 do 1000).

WYKONANIA SPECJALNE

dla modeli od 800 do 1000:

- II 2G Ex h IIB T4,
- II 2G Ex h IIB+H2 T4 (silnik Ex d IIC T4),
- II 3D c T125°C.

DANE TECHNICZNE DLA WENTYLATORÓW WYWIEWNYCH (TYP B)

Typ	predkość obrotowa	wydajność max	poziom ciśnienia akustycznego*		masa	nr artykułu
	[obr/min]	[m³/h]	[dB(A)]		[kg]	
HCTT/4-315-B	1300	1930	59	58	14,4	43525731
HCTT/4-355-B	1260	2680	56	55	15,8	43525745
HCTT/4-400-B	1350	3700	59	58	16,5	43525755
HCTT/4-450-B	1230	5600	63	61	23,5	43525765
HCTT/4-500-B	1350	7100	69	67	25,4	43525775
HCTT/4-560-B	1320	9820	73	69	40	43525785
HCTT/4-630-B	1290	13000	74	70	42,6	43525795
HCTT/4-710-B	1300	18400	82	80	60	43525805
HCTT/4-800-B	1400	23800	89	86	67	43525815
HCTT/4-900-B	1400	30000	92	89	77	43525825
HCTT/4-1000-B	1450	38500	93	90	123	43525898
HCTT/6-450-B	835	3900	53	52	23,5	43525835
HCTT/6-500-B	830	4600	56	54	25,4	43525845
HCTT/6-560-B	850	6850	60	58	40	43525855
HCTT/6-630-B	810	8400	64	61	42,6	43525865
HCTT/6-710-B	900	12700	72	70	54	43525875
HCTT/6-800-B	930	15800	79	76	57	43525885
HCTT/6-900-B	930	20000	82	79	67	43525895
HCTT/6-1000-B	930	24700	83	80	108	43525905
HCTT/8-710-B	670	9500	64	62	52	43525915
HCTT/8-800-B	700	11900	71	68	57	43525925
HCTT/8-900-B	700	15000	74	71	67	43525935
HCTT/8-1000-B	700	18600	75	72	108	43525945

* Mierzony w wolnej przestrzeni z odległości 1,5 m.

DANE TECHNICZNE DLA WENTYLATORÓW NAWIEWNYCH (TYP A)

Typ	prędkość obrotowa	wydajność max	poziom ciśnienia akustycznego* wlot wylot		masa	nr artykułu
	[obr/min]	[m ³ /h]	[dB(A)]		[kg]	
HCTT/4-315-A	1360	2150	58	64	14,4	43525731-01
HCTT/4-355-A	1350	3250	59	61	15,8	43525745-01
HCTT/4-400-A	1380	4720	64	68	16,5	43525755-01
HCTT/4-450-A	1350	6670	68	71	23,5	43525765-01
HCTT/4-500-A	1380	8440	72	76	25,4	43525775-01
HCTT/4-560-A	1380	11400	75	80	40	43525785-01
HCTT/4-630-A	1360	15300	79	84	42,6	43525795-01
HCTT/4-710-A	1300	20500	80	85	60	43525805-01
HCTT/4-800-A	1400	26600	85	90	67	43525815-01
HCTT/4-900-A	1400	35900	88	94	77	43525825-01
HCTT/4-1000-A	1400	44900	89	95	123	43525898-01
HCTT/6-450-A	835	4400	56	60	23,5	43525835-01
HCTT/6-500-A	830	5500	60	63	25,4	43525845-01
HCTT/6-560-A	850	7900	64	68	40	43525855-01
HCTT/6-630-A	810	9900	66	70	42,6	43525865-01
HCTT/6-710-A	900	14200	69	75	54	43525875-01
HCTT/6-800-A	930	17700	75	80	57	43525885-01
HCTT/6-900-A	930	23800	78	84	67	43525895-01
HCTT/6-1000-A	930	28800	79	85	108	43525905-01
HCTT/8-710-A	670	-	67	52	52	43525915-01
HCTT/8-800-A	700	13300	67	72	57	43525925-01
HCTT/8-900-A	700	18000	70	76	67	43525935-01
HCTT/8-1000-A	700	21700	71	77	108	43525945-01

* Mierzony w wolnej przestrzeni z odległości 1,5 m

** Moc nominalna

CHARAKTERYSTYKI PRACY - WYWIEW (TYP B)

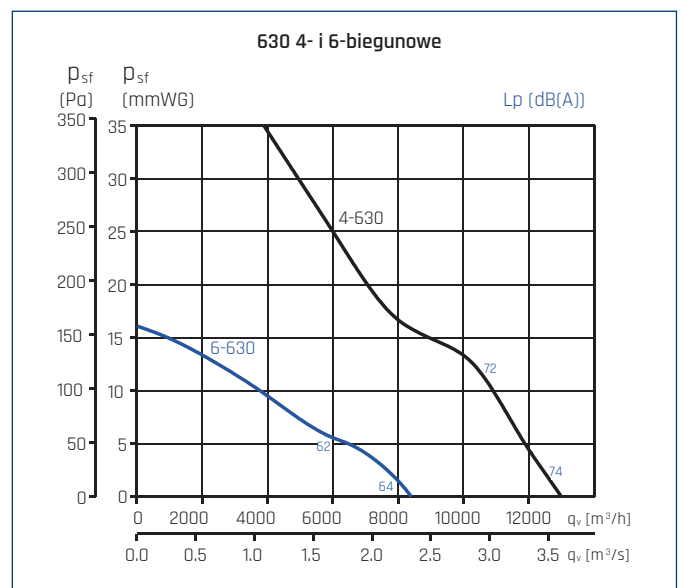
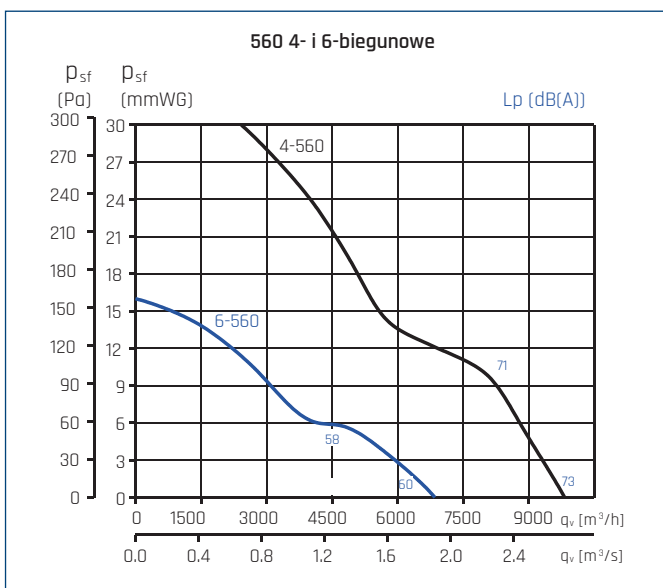
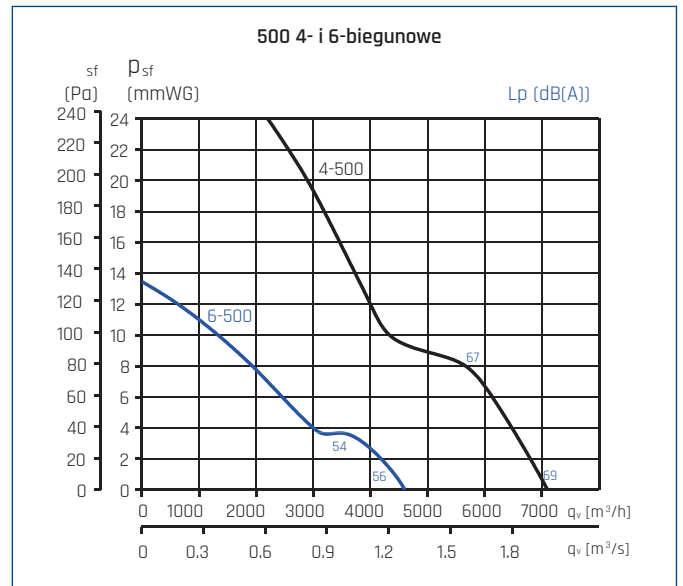
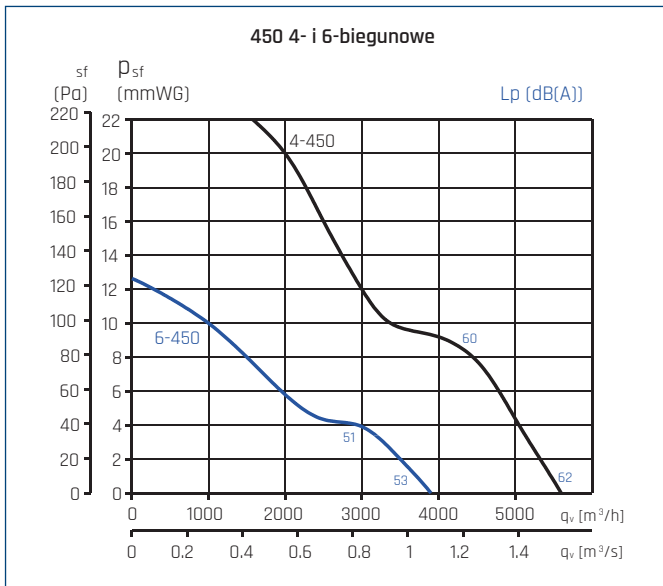
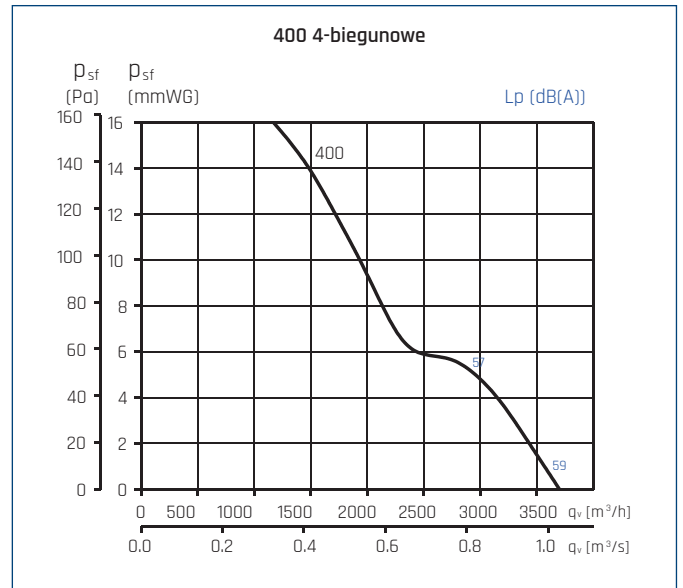
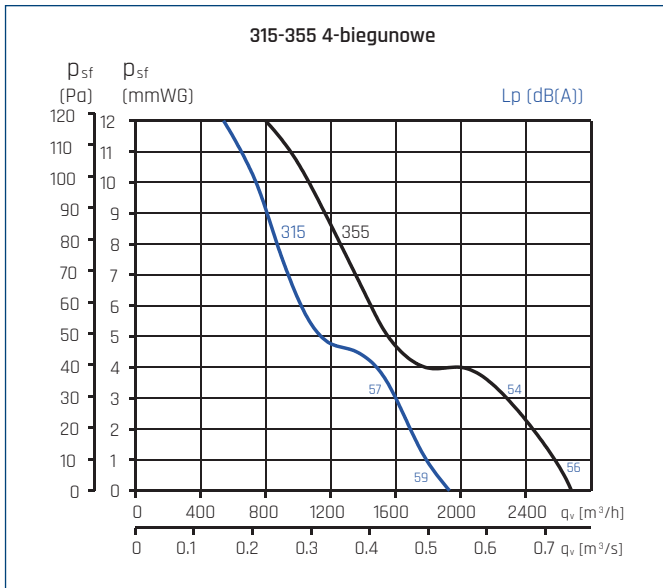

CHARAKTERYSTYKI PRACY - WYWIEW (TYP B)

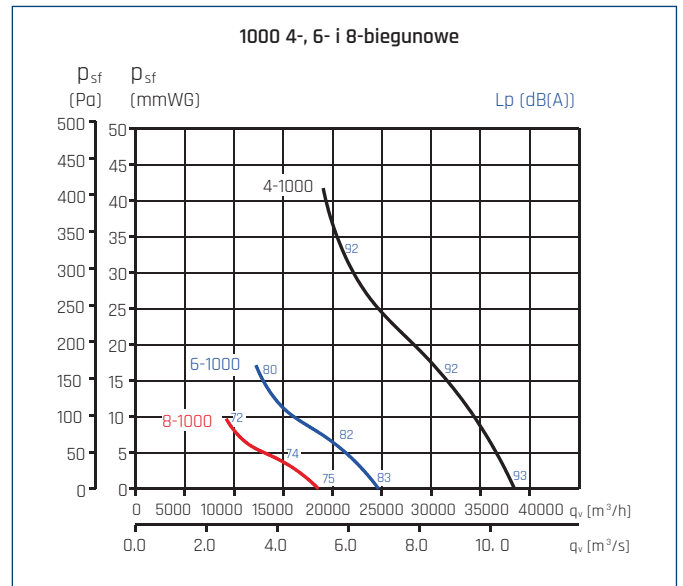
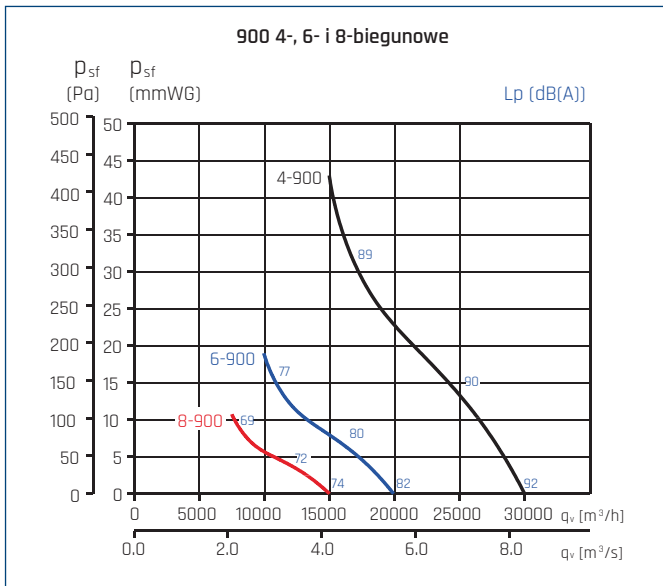
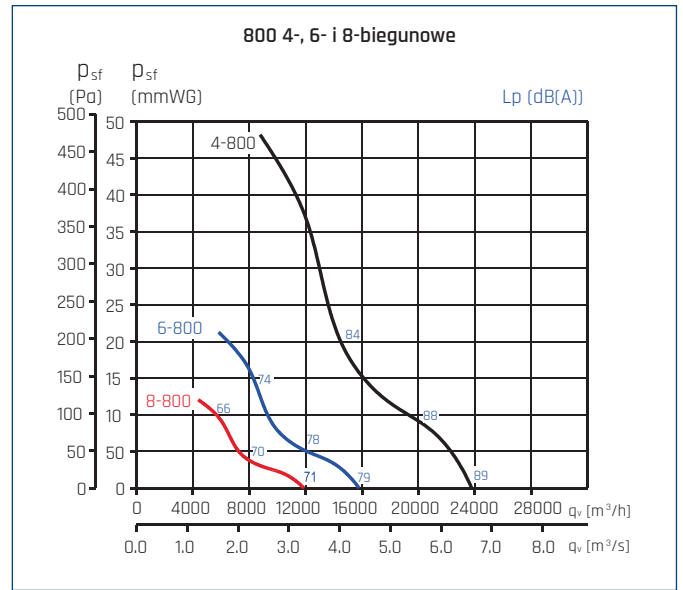
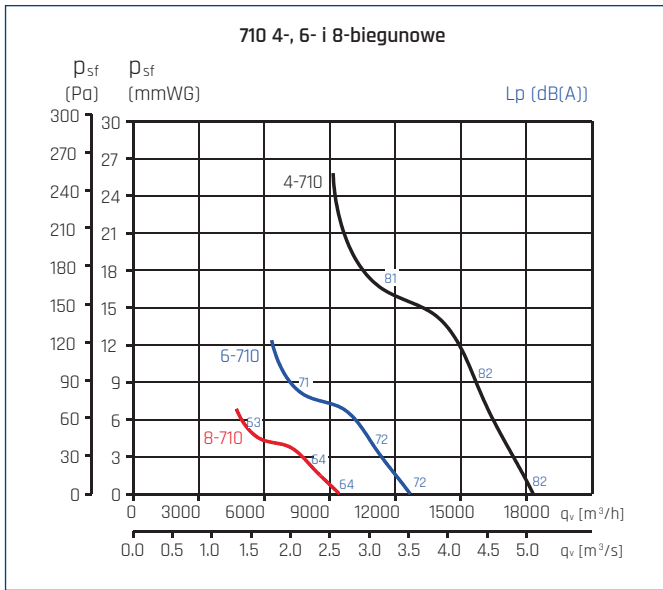

CHARAKTERYSTYKI PRACY - NAWIEW (TYP A)

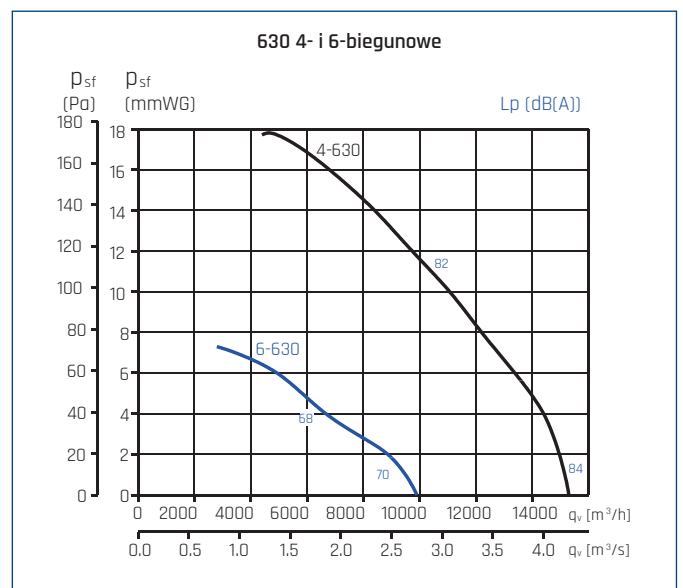
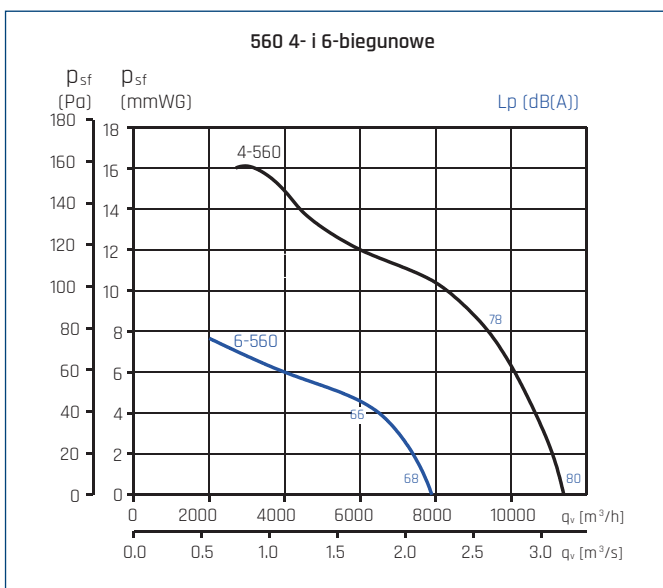
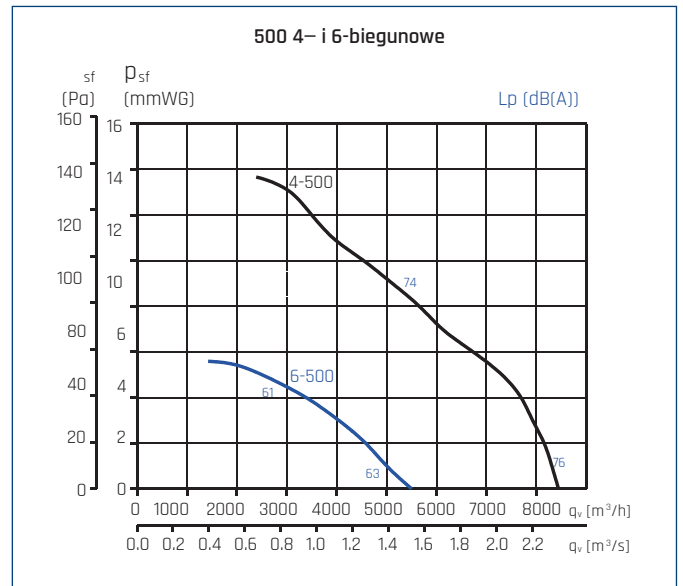
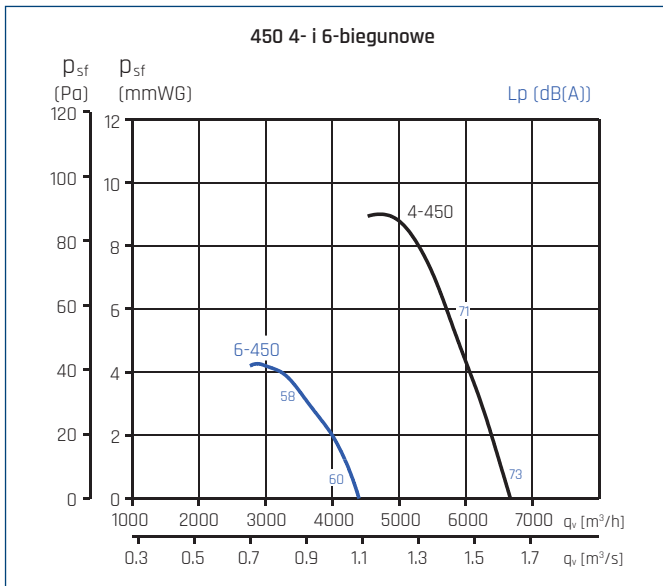
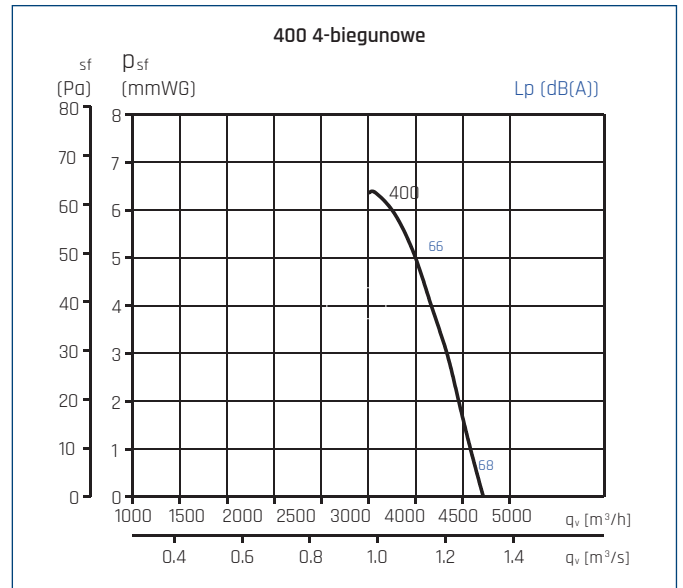
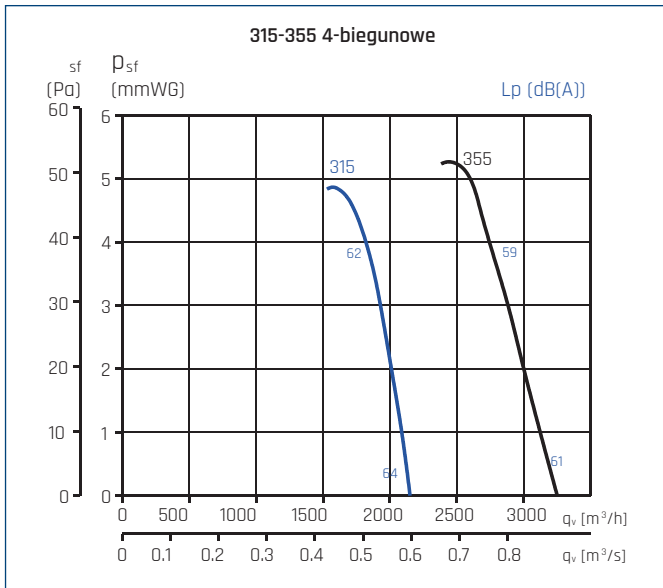

CHARAKTERYSTYKI PRACY - NAWIEW (TYP A)

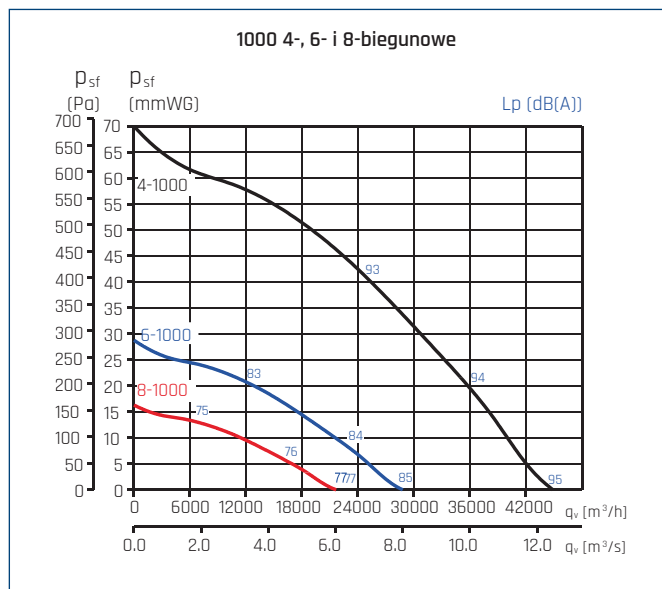
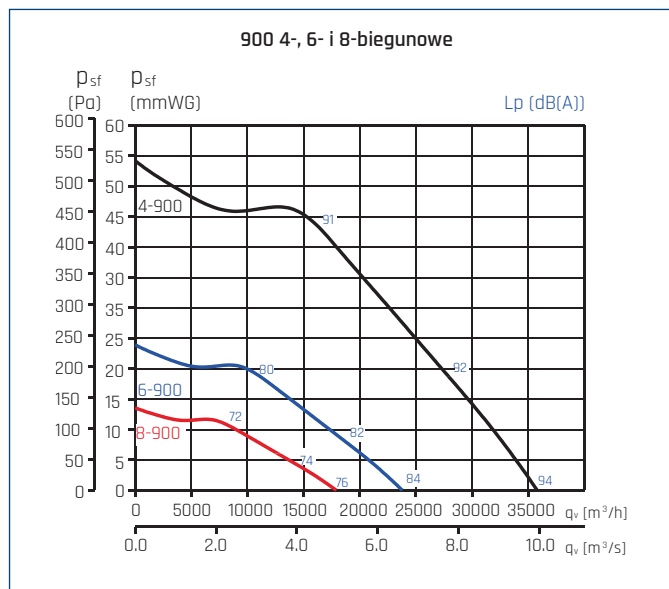
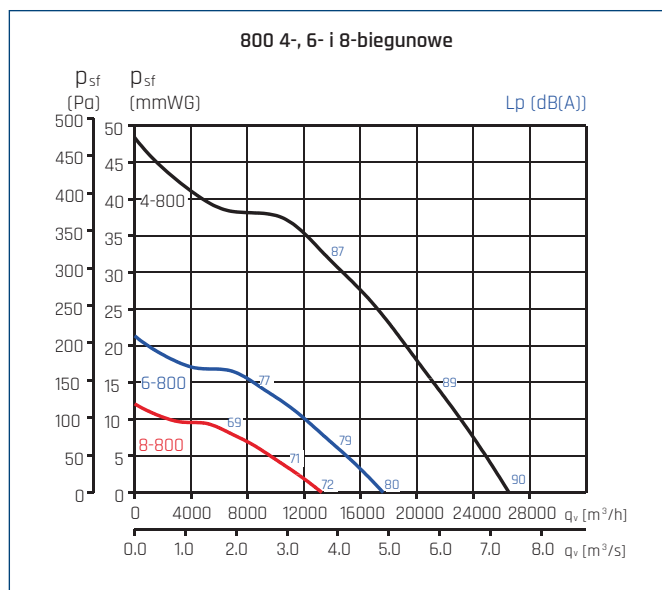
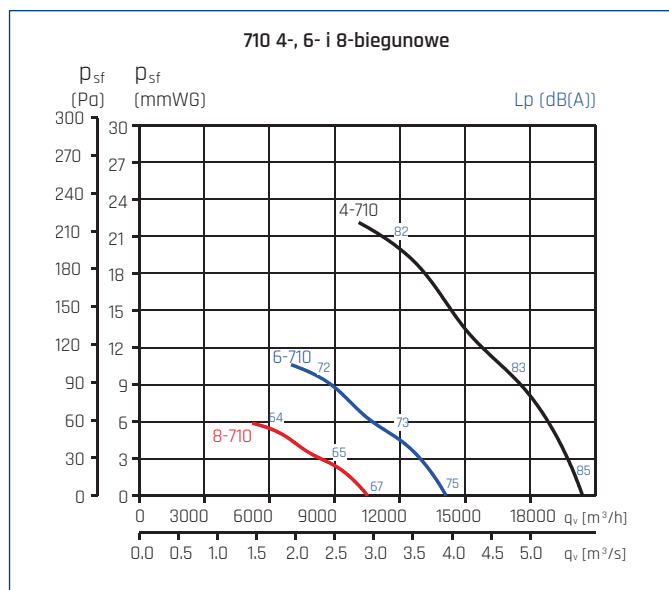

WYMIARY [mm]

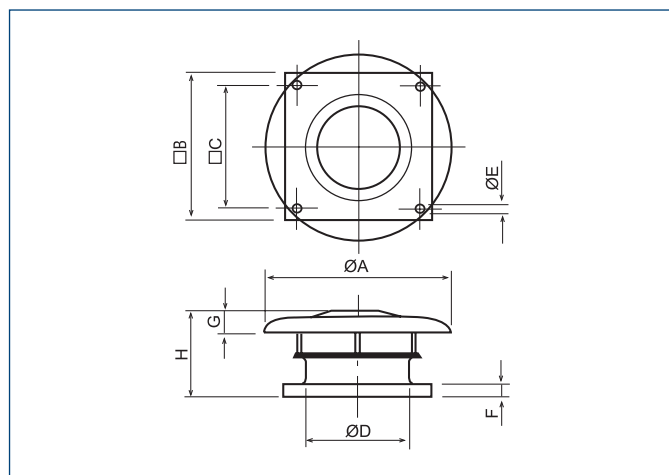

Typ	ØA	□B	□C	ØD	ØE	F	G	H
315	640	560	450	315	12	40	70	341
355	760	630	535	355	12	40	80	361
400	760	630	535	400	12	40	80	361
450	895	710	590	450	14	40	110	410
500	895	710	590	500	14	40	110	410
560	1150	905	750	560	14	50	165	488
630	1150	905	750	630	14	50	165	488
710	1350	1100	840	710	14	50	200	551
800	1350	1100	840	800	14	50	200	732
900	1580	1250	950	900	14	50	200	756
1000	1580	1250	950	1000	14	50	200	756