

## ZASTOSOWANIE

Wentylator promieniowy bez obudowy przeznaczony do transportu powietrza czystego lub lekko zapyłonego. Typowe zastosowania:

- centrale wentylacyjne,
- systemy suszące,
- układy recyrkulacji powietrza,
- komory lakiernicze.

## KONSTRUKCJA

- wentylator promieniowy o napędzie bezpośrednim,
- wirnik aluminiowy z łopatkami pochylonymi do tyłu, wyważony dynamicznie wg ISO 21940-1,
- wentylator przystosowany do pracy w pozycji poziomej,
- wentylator aluminiowy ze stalowymi elementami podstawy malowanymi na kolor szary RAL 7042,
- zakres temperatur pracy wentylatora od -20°C do +40°C,
- lej wlotowy wyposażony w 4 nypły Ø6mm do pomiaru ciśnienia rozłożone równomiernie na obwodzie wlotu w pobliżu wirnika.

## SILNIK ELEKTRYCZNY

- asynchroniczny, trójfazowy, 230/400V 50Hz lub 400/690V 50Hz,
- stopień ochrony IP55,
- klasa izolacji F,
- do regulacji częstotliwościowej.

## WYKONANIA SPECJALNE

- malowanie na kolor inny niż standardowy,
- silnik na inne niż standardowe napięcie oraz częstotliwość zasilania,
- silnik o innym stopniu ochrony IP,
- zakres temperatur pracy wentylatora poniżej -20°C oraz powyżej +40°C.



## DANE TECHNICZNE

Typ	wydajność max	ciśnienie max	moc silnika	prędkość obrotowa	natężenie	napięcie	poziom ciśn. akust.*	masa	nr artykułu
	[m³/h]	[Pa]	[kW]	[obr/min]	[A]	[V]	[dB(A)]	[kg]	
PBM-2-250-055T	1960	730	0,55	2790	2,35 / 1,35	230 / 400	69	16	461125205
PBM-2-280-110T	2760	980	1,1	2890	4,3 / 2,5	230 / 400	72	23	461128211
PBM-2-315-150T	3860	1220	1,5	2880	5,25 / 3,0	230 / 400	75	32	461131215
PBM-2-355-300T	5565	1545	3,0	2890	11 / 6,3	230 / 400	79	39	461135230
PBM-4-355-037T	2640	350	0,37	1370	1,25 / 2,2	230 / 400	64	20	461135403
PBM-2-400-550T	8000	2040	5,5	2925	9,8 / 5,7	400 / 690	82	83	461140255
PBM-4-400-075T	3920	480	0,75	1430	3,5 / 2,1	230 / 400	67	40	461140407
PBM-2-450-1100T	11580	2615	11,0	2945	19,1 / 11,1	400 / 690	86	112	461145211
PBM-4-450-110T	5650	615	1,1	1425	4,3 / 2,5	230 / 400	71	62	461145411
PBM-2-500-1500T	16440	3280	15,0	2940	26,5 / 15,4	400 / 690	89	128	461150215
PBM-4-500-220T	8000	780	2,2	1435	8,5 / 5,1	230 / 400	75	75	461150422
PBM-4-560-300T	11080	980	3,0	1445	11,6 / 6,8	230 / 400	78	81	461156430
PBM-6-560-150T	7480	435	1,5	930	7,2 / 4,2	230 / 400	69	75	461156615
PBM-4-630-550T	15700	1230	5,5	1455	11,1 / 6,8	400 / 690	81	156	461163455
PBM-6-630-220T	10220	530	2,2	950	9,9 / 5,8	230 / 400	73	112	461163622
PBM-4-710-1100T	22480	1600	11,0	1465	21,2 / 12,3	400 / 690	85	236	461171411
PBM-6-710-300T	14800	690	3,0	965	12,3 / 7,2	230 / 400	76	158	461171630
PBM-4-800-1850T	32300	2045	18,5	1470	35 / 23	400 / 690	88	287	461180418
PBM-6-800-550T	21880	860	5,5	950	12,3 / 7,1	400 / 690	78	205	461180655

\* pomiar wykonany w odległości 1m od wentylatora, dla Q=2/3\*Qmax

## CHARAKTERYSTYKI PRACY

- MC      Kategoria pomiarowa
- EC      Kategoria sprawności
- VSD     Regulacja prędkości
- SR      Ilość biegów
- $\eta$  [%]   Sprawność
- N       Współczynnik sprawności
- [kW]     Pobór mocy
- [m<sup>3</sup>/h]   Wydajność
- [Pa]      Ciśnienie całkowite
- [RPM]    Prędkość obrotowa

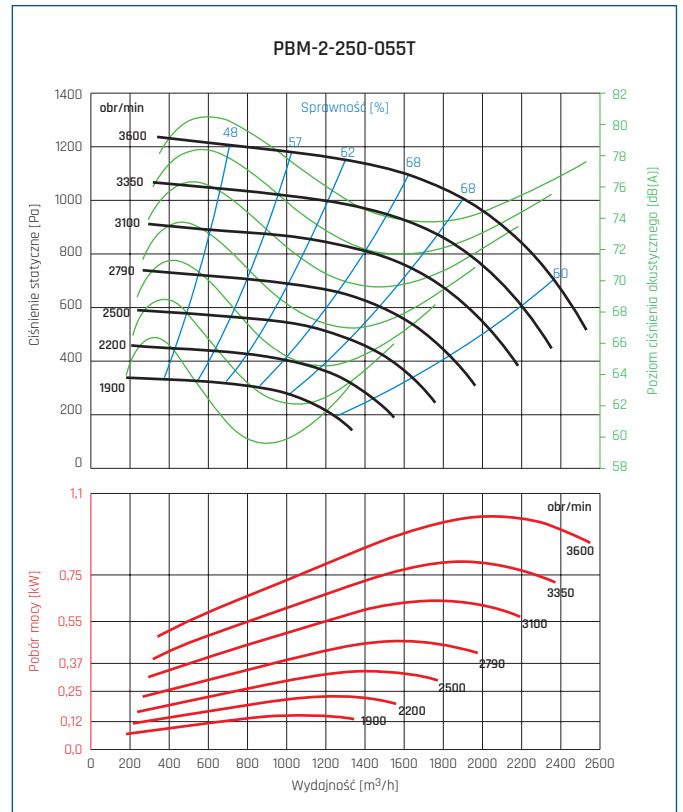

MC	EC	VSD	SR	$\eta$ [%]	N	[kW]	[m <sup>3</sup> /h]	[Pa]	[RPM]
B	Całkowita	Nie	1	52,9	67,2	0,44	1263	662	2790

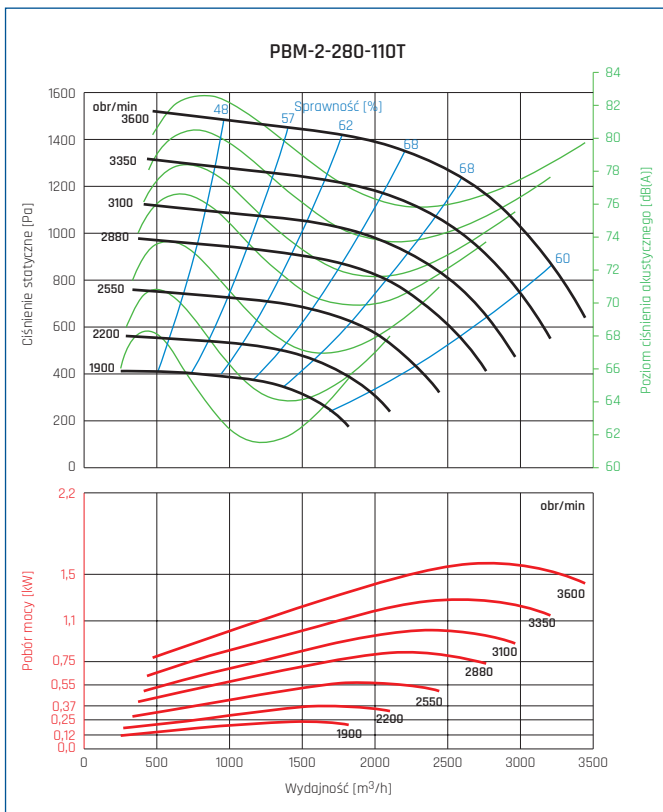

MC	EC	VSD	SR	$\eta$ [%]	N	[kW]	[m <sup>3</sup> /h]	[Pa]	[RPM]
B	Całkowita	Nie	1	55,6	67,2	0,78	1783	874	2890

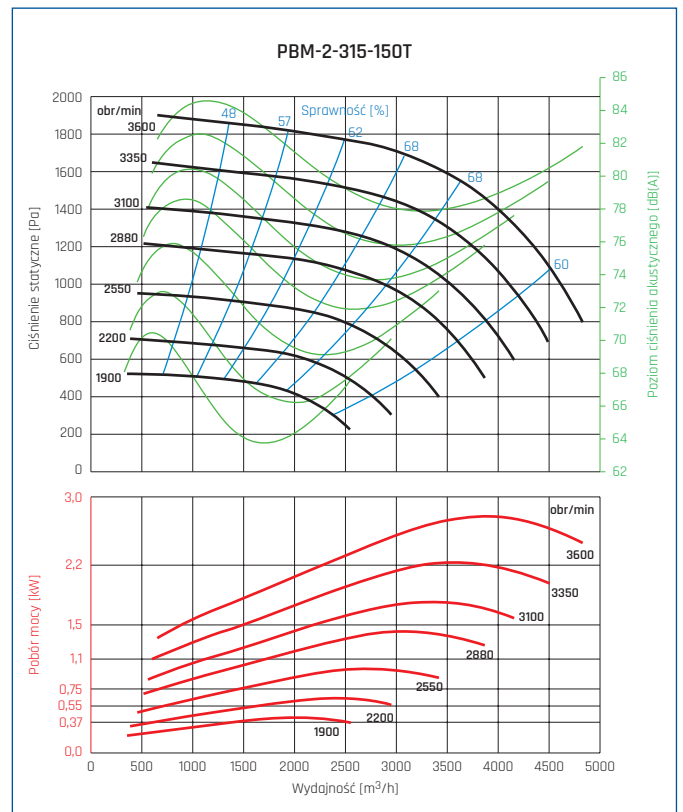

MC	EC	VSD	SR	$\eta$ [%]	N	[kW]	[m <sup>3</sup> /h]	[Pa]	[RPM]
B	Całkowita	Nie	1	56,4	65,6	1,33	2488	1086	2880

CHARAKTERYSTYKI PRACY

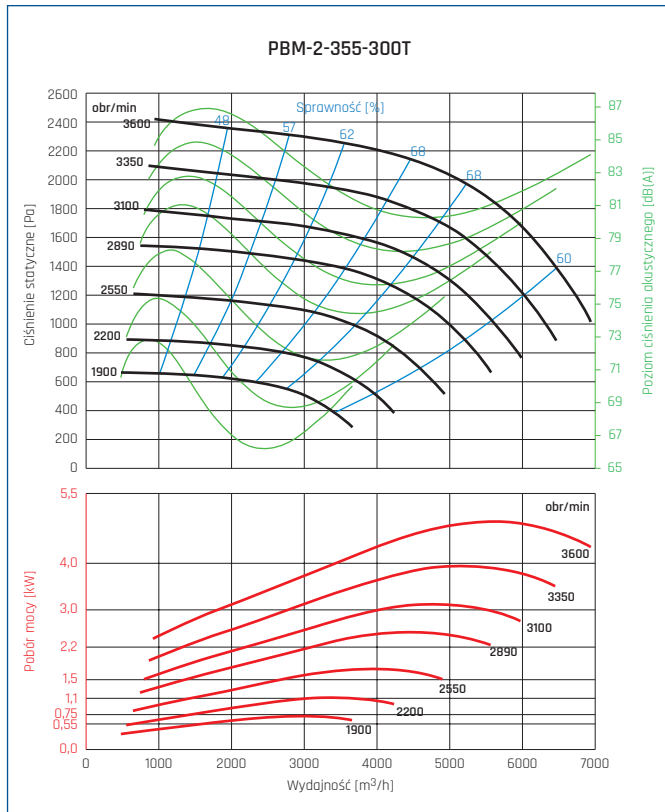

MC	EC	VSD	SR	η [%]	N	[kW]	[m³/h]	[Pa]	[RPM]
B	Całkowita	Nie	1	58,3	64,8	2,38	3585	1391	2890

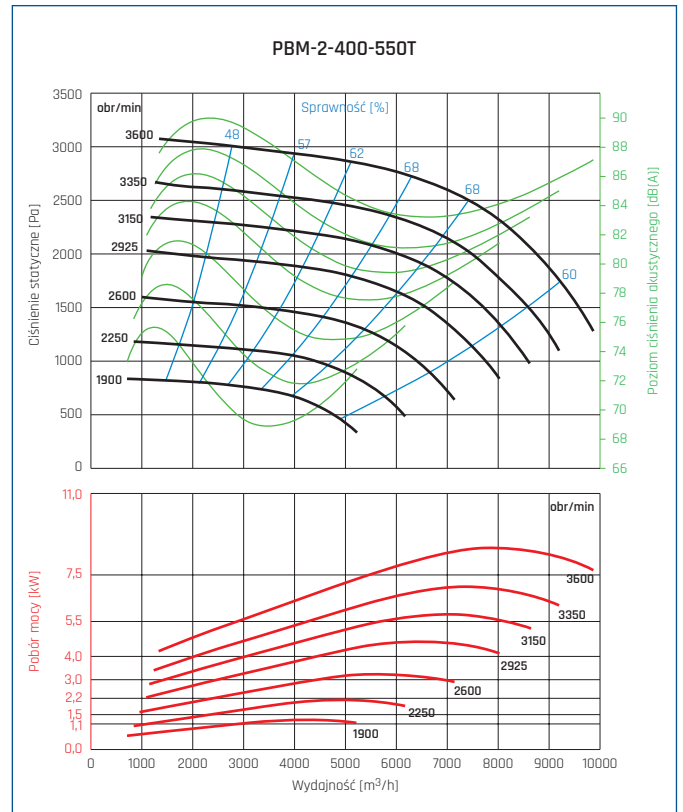

MC	EC	VSD	SR	η [%]	N	[kW]	[m³/h]	[Pa]	[RPM]
B	Całkowita	Nie	1	59,2	63,0	4,36	5161	1801	2925

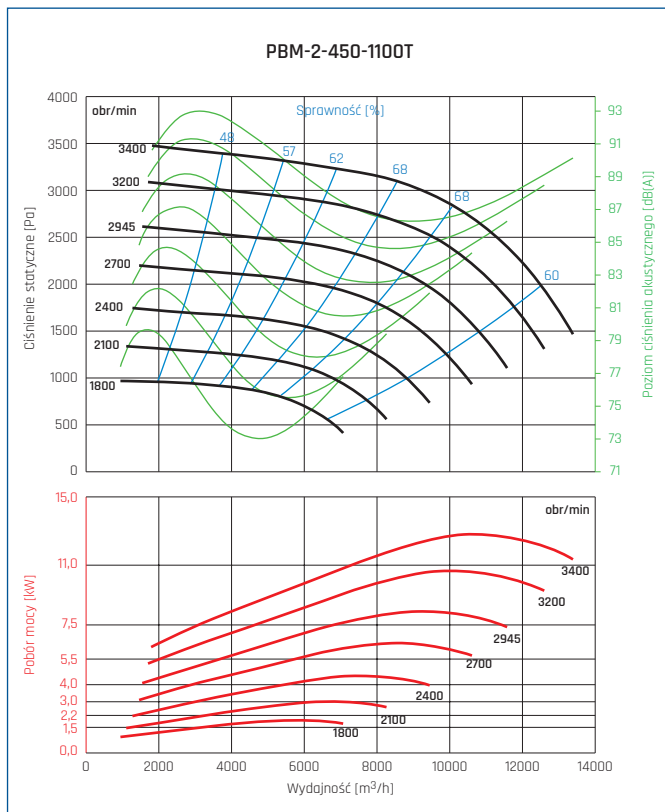

MC	EC	VSD	SR	η [%]	N	[kW]	[m³/h]	[Pa]	[RPM]
B	Całkowita	Nie	1	61,7	62,0	7,81	7460	2324	2945

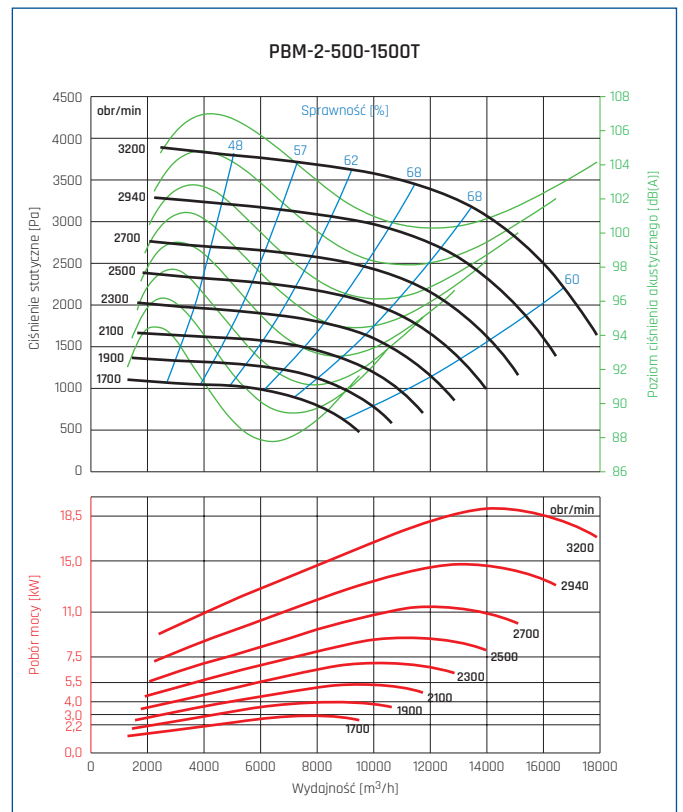

MC	EC	VSD	SR	η [%]	N	[kW]	[m³/h]	[Pa]	[RPM]
B	Całkowita	Nie	1	62,2	62,0	13,84	10588	2930	2940

CHARAKTERYSTYKI PRACY

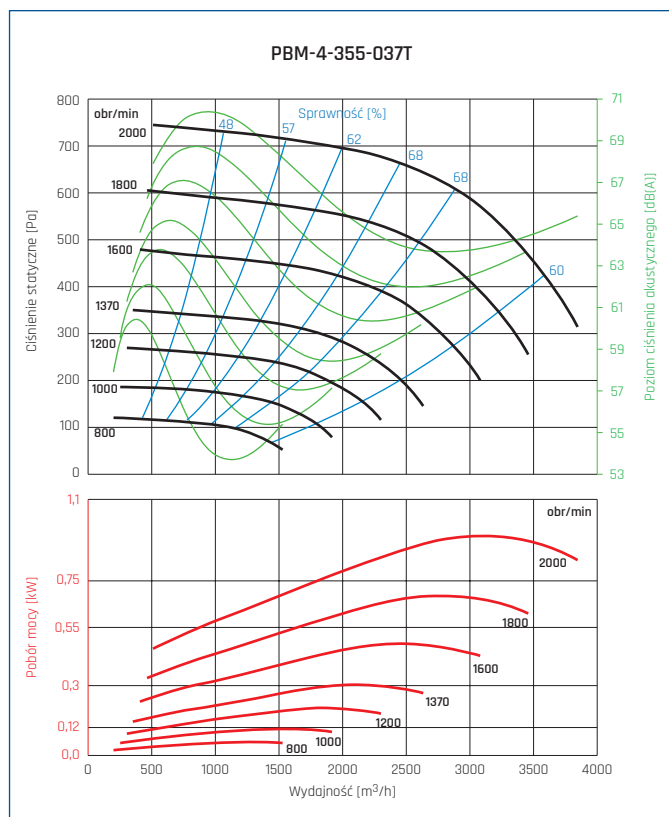

MC	EC	VSD	SR	η [%]	N	[kW]	[m³/h]	[Pa]	[RPM]
B	Całkowita	Nie	1	51,8	68,0	0,29	1699	322	1370

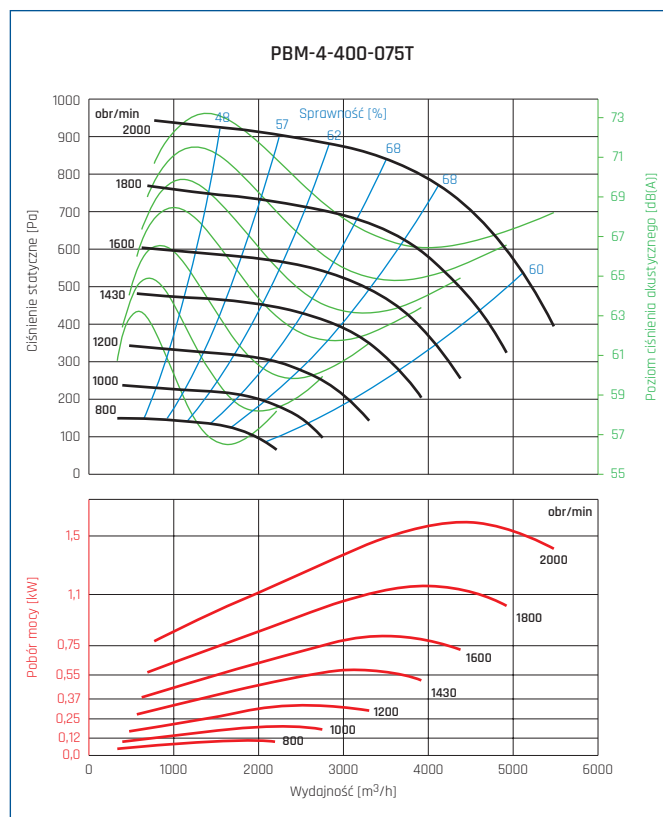

MC	EC	VSD	SR	η [%]	N	[kW]	[m³/h]	[Pa]	[RPM]
B	Całkowita	Nie	1	55,2	68,4	0,55	2523	430	1430

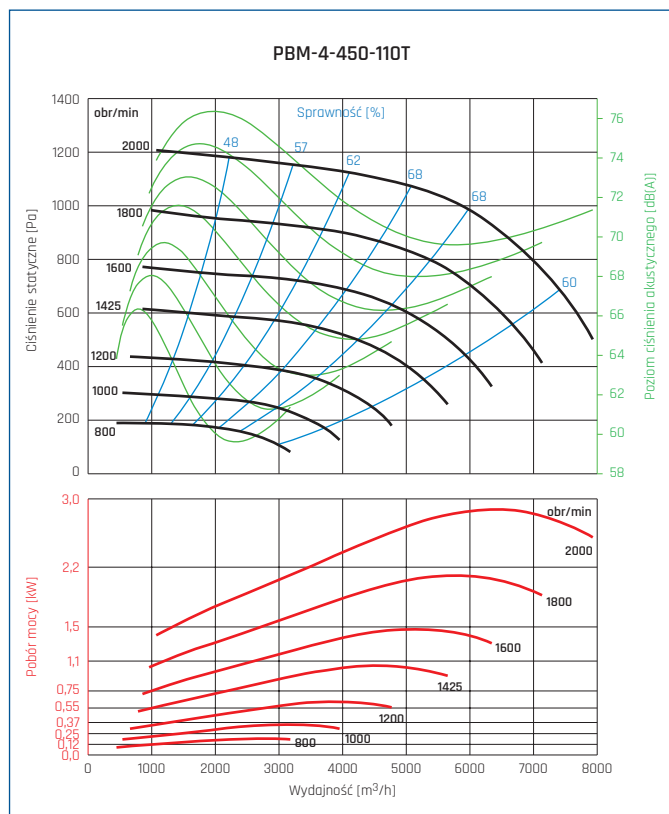

MC	EC	VSD	SR	η [%]	N	[kW]	[m³/h]	[Pa]	[RPM]
B	Całkowita	Nie	1	56,3	66,9	0,98	3633	547	1425

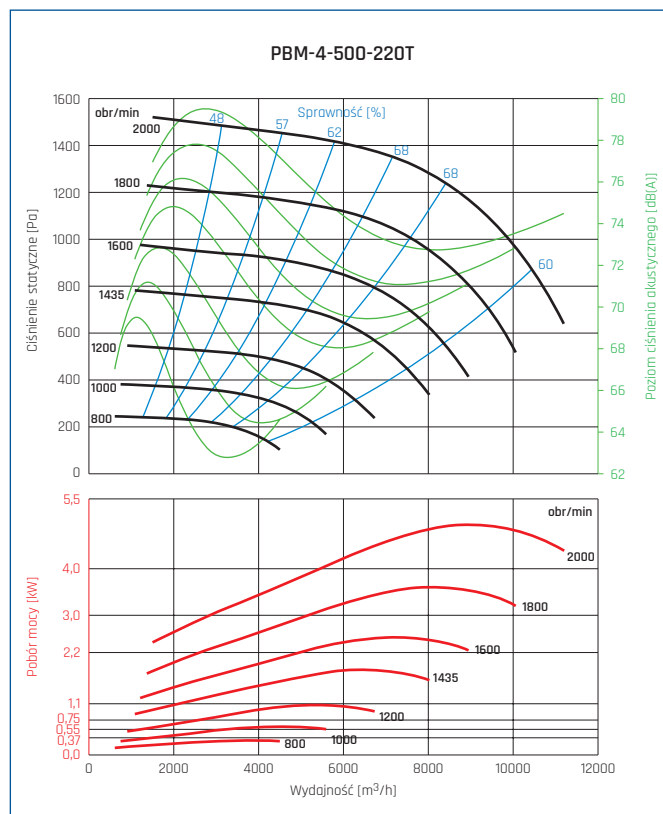

MC	EC	VSD	SR	η [%]	N	[kW]	[m³/h]	[Pa]	[RPM]
B	Całkowita	Nie	1	58	66,0	1,73	5168	698	1435

CHARAKTERYSTYKI PRACY

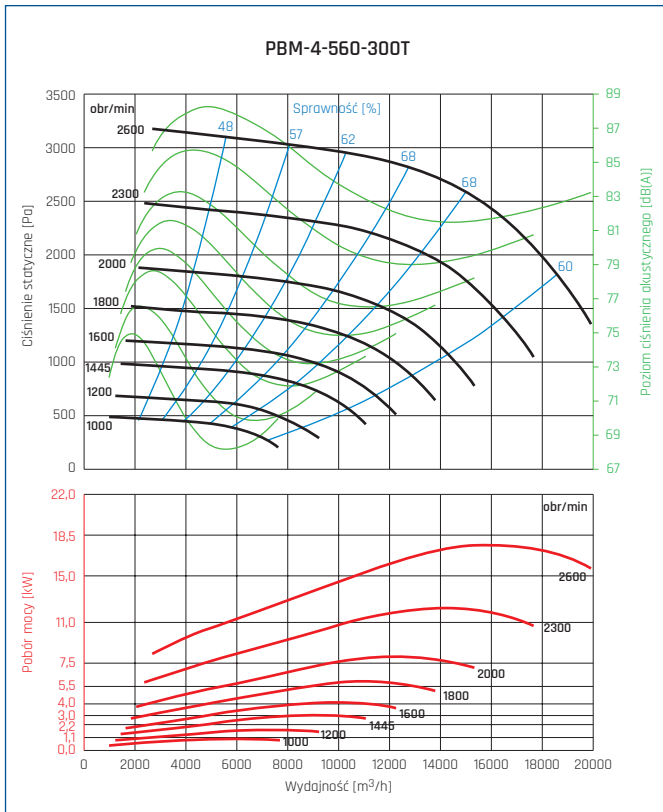

MC	EC	VSD	SR	η [%]	N	[kW]	[m³/h]	[Pa]	[RPM]
B	Całkowita	Nie	1	60,5	66,2	2,86	7131	874	1445

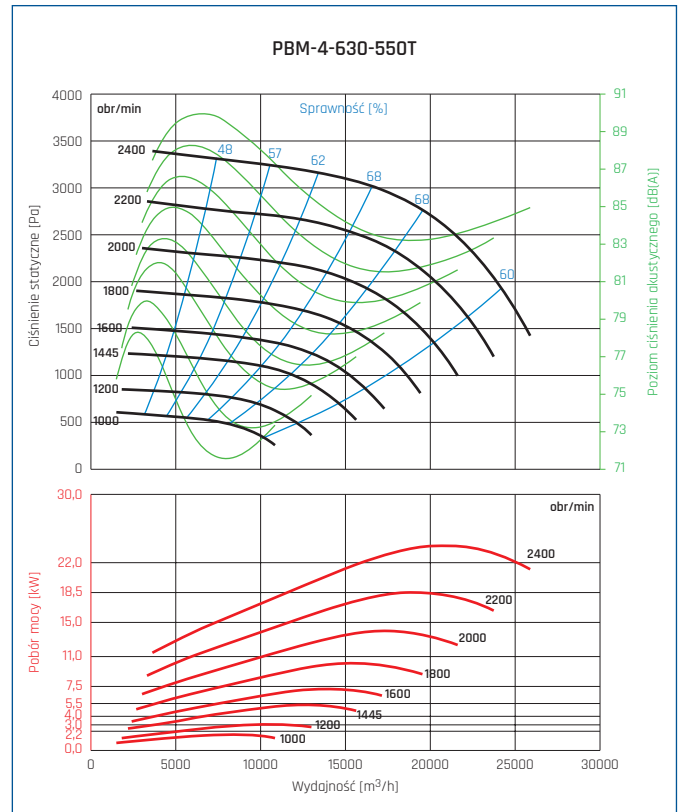

MC	EC	VSD	SR	η [%]	N	[kW]	[m³/h]	[Pa]	[RPM]
B	Całkowita	Nie	1	61,8	64,9	5,05	10104	1112	1455

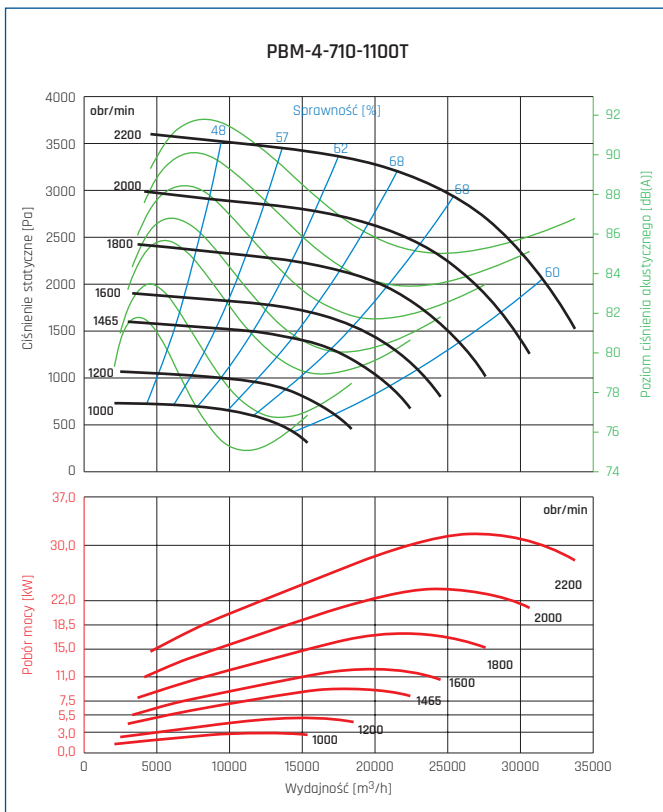

MC	EC	VSD	SR	η [%]	N	[kW]	[m³/h]	[Pa]	[RPM]
B	Całkowita	Nie	1	64,7	64,9	8,87	14478	1426	1465

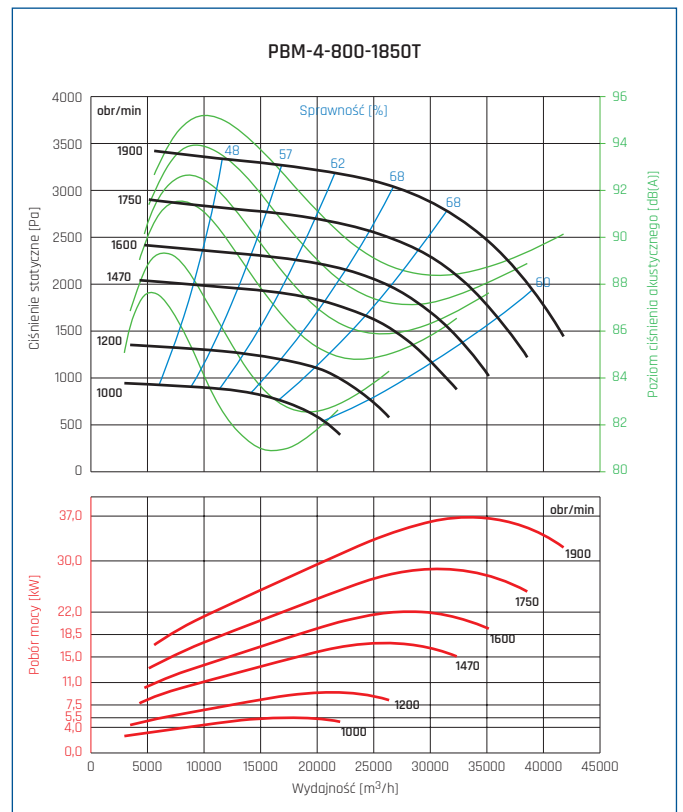

MC	EC	VSD	SR	η [%]	N	[kW]	[m³/h]	[Pa]	[RPM]
B	Całkowita	Nie	1	61,8	65,2	16,09	20828	1825	1470

## CHARAKTERYSTYKI PRACY

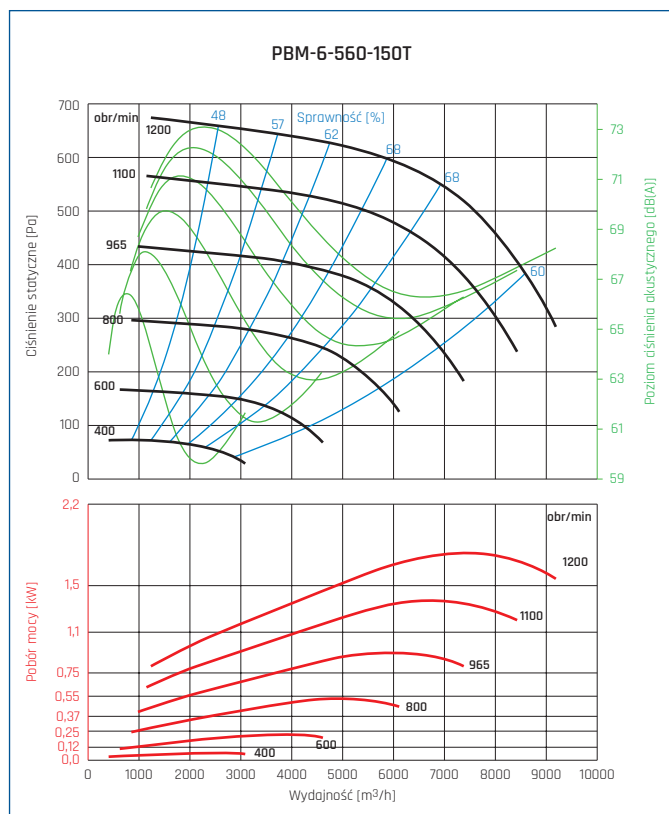

MC	EC	VSD	SR	η [%]	N	[kW]	[m³/h]	[Pa]	[RPM]
B	Całkowita	Nie	1	58,5	70,1	0,79	4589	362	930

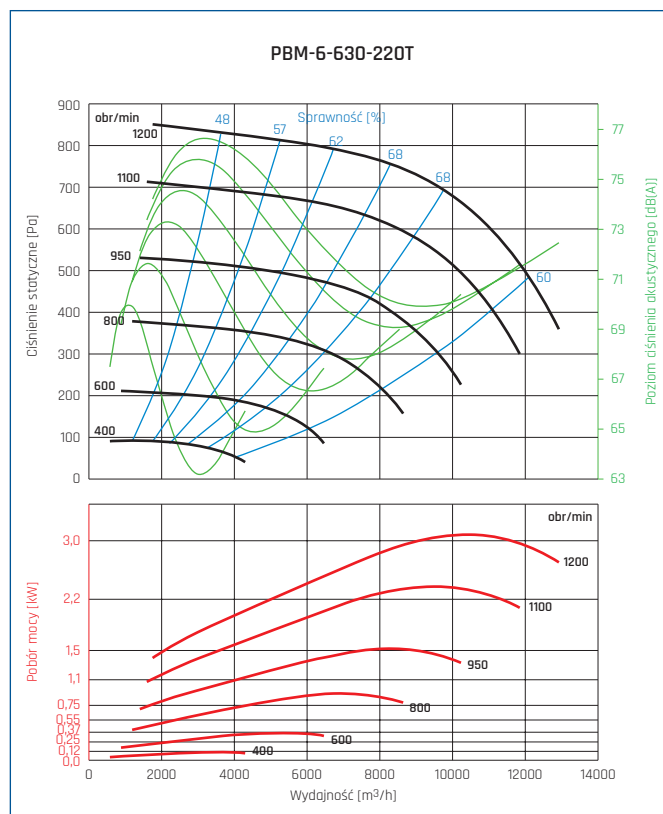

MC	EC	VSD	SR	η [%]	N	[kW]	[m³/h]	[Pa]	[RPM]
B	Całkowita	Nie	1	59,8	68,6	1,45	6597	474	950

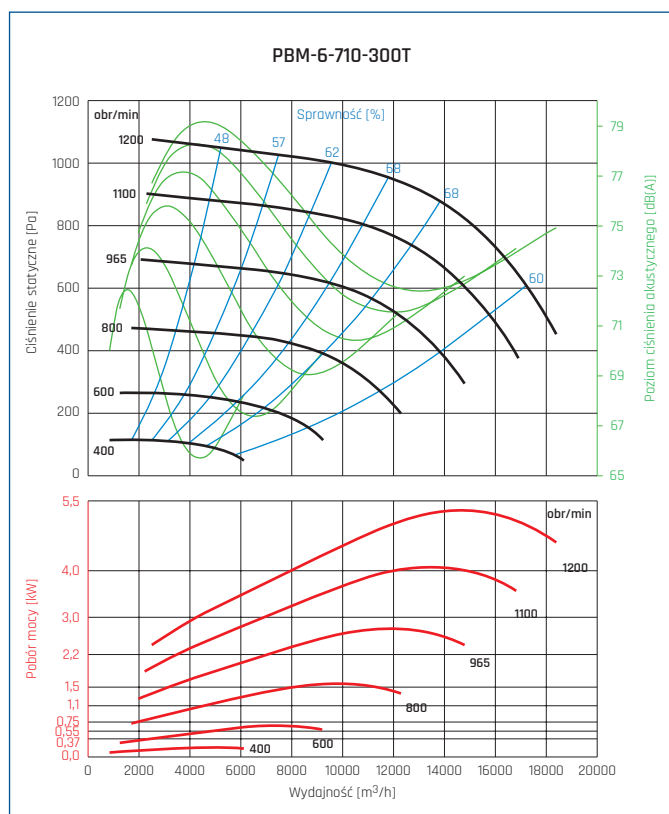

MC	EC	VSD	SR	η [%]	N	[kW]	[m³/h]	[Pa]	[RPM]
B	Całkowita	Nie	1	62,5	68,6	2,62	9537	619	965

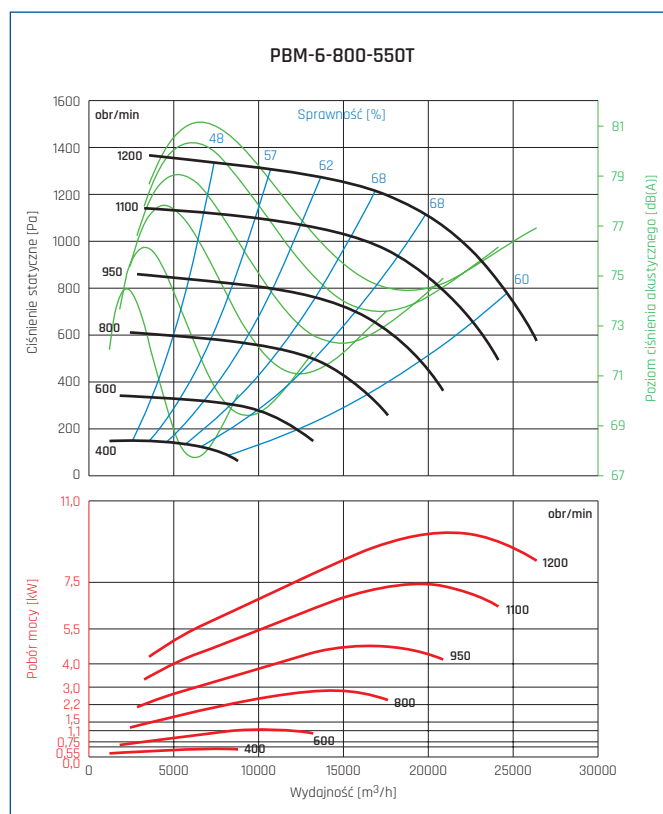

MC	EC	VSD	SR	η [%]	N	[kW]	[m³/h]	[Pa]	[RPM]
B	Całkowita	Nie	1	63,2	66,9	4,51	13460	762	950

## WYMIARY [mm]

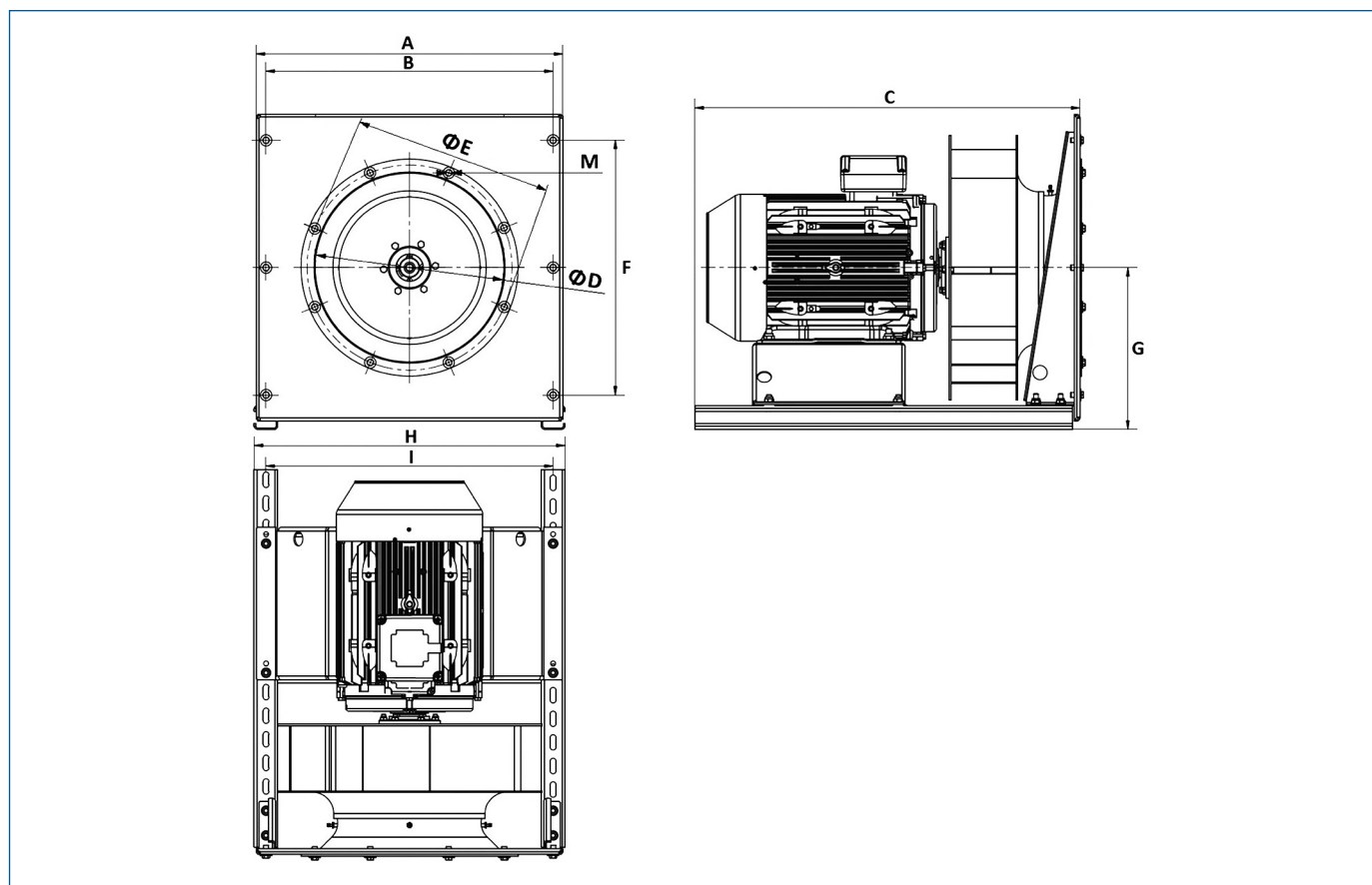

Typ	A	B	C	ØD	ØE	F	G	H	I	M
PBM-250	400	359	415	200	225	290	217,5	409	359	6 x M6
PBM-280	400	359	465	225	250	290	217,5	409	359	6 x M6
PBM-315	500	459	515	250	275	390	267,5	509	459	6 x M6
PBM-355	500	460	565	280	310	390	265,0	510	460	8 x M6
PBM-400	600	559	605	311	340	490	317,5	609	559	8 x M6
PBM-450	600	559	815	354	385	490	317,5	609	559	8 x M6
PBM-500	650	609	816	400	435	540	342,5	659	609	8 x M8
PBM-560	700	659	676	450	485	590	367,5	709	659	12 x M8

## WYMIARY [mm]

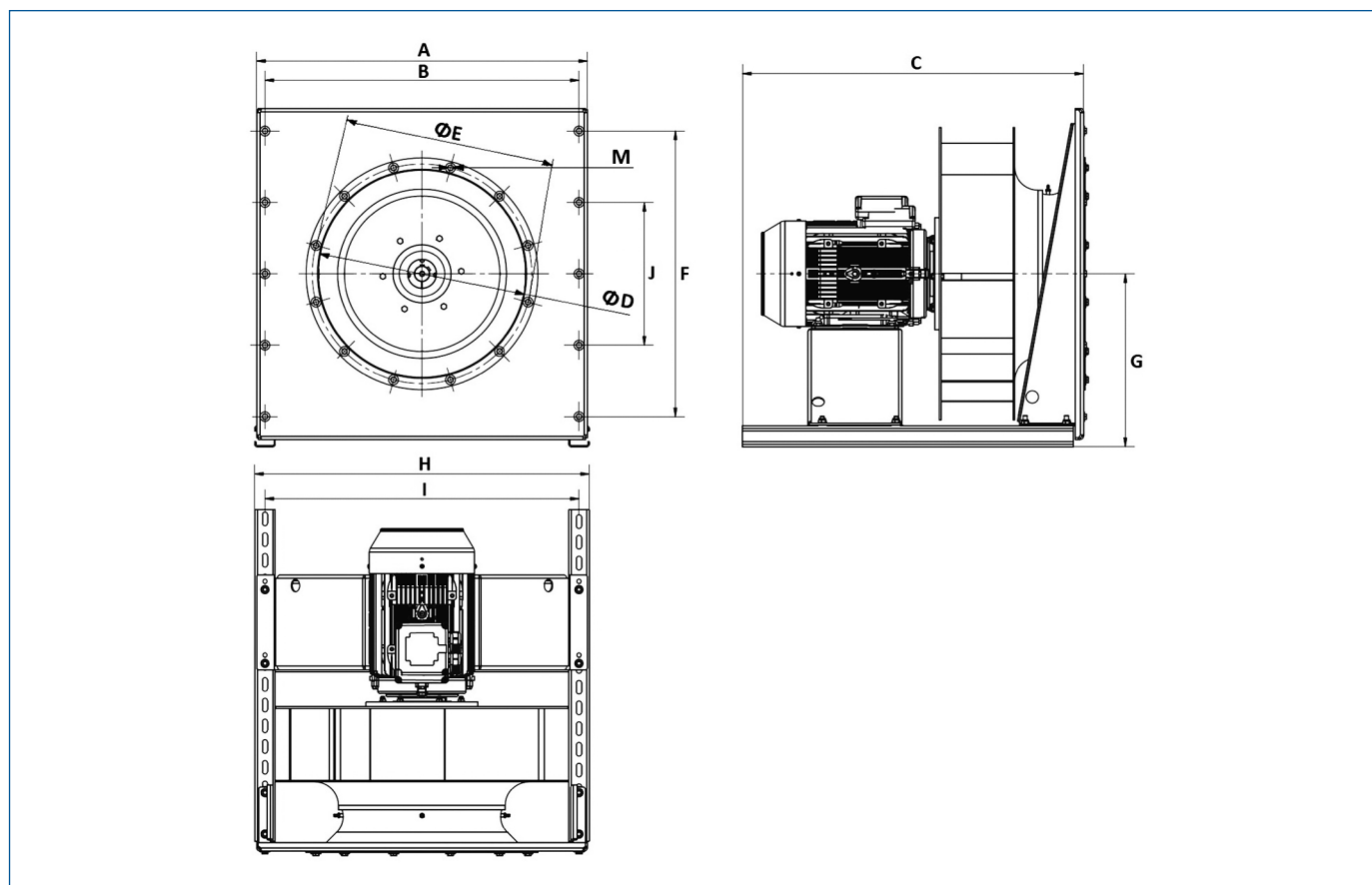

Typ	A	B	C	ØD	ØE	F	G	H	I	J	M
PBM-630	800	759	824	500	530	690	417,5	809	759	345	12 x M8
PBM-710	900	859	964	560	600	790	467,5	909	859	395	12 x M8
PBM-800	1000	959	1064	630	670	890	517,5	1009	959	445	12 x M8