



Zastosowanie

Wentylator przeznaczony do wszelkiego rodzaju instalacji wentylacji ogólnej.

Typowe zastosowania to:

- ogólna wentylacja lokali handlowych i hal przemysłowych,
- wentylacja magazynów i składów magazynowych,
- wentylacja garaży i budynków użyteczności publicznej etc.

Konstrukcja

- łopaty z tworzywa sztucznego PPG, piasta aluminiowa,
- wirnik wyważony dynamicznie zgodnie z ISO 21940-11:2016,
- obudowa spawana z blachy stalowej,
- przykręcana stalowa płyta silnika,
- kierunek przepływu wirnik -> silnik,
- wentylator malowany na kolor czarny RAL 9005,
- kłapa rewizyjna na obudowie,
- montaż w pozycji poziomej lub pionowej.

Silnik elektryczny

- asynchroniczny, jednofazowy 230V 50Hz,
- asynchroniczny, trójfazowy 230/400V 50Hz, 400/690V 50Hz,
- stopień ochrony IP 55, klasa izolacji F,
- do regulacji napięciowej (silniki jednofazowe),
- do regulacji częstotliwościowej (silniki trójfazowe).

Wykonania specjalne

- wirnik aluminiowy,
- malowanie na kolor inny niż standardowy,
- malowanie w wyższej kategorii korozyjności,
- obudowa z blachy stalowej ocynkowanej,
- obudowa z blachy stalowej nierdzewnej 1.4301,
- obudowa z blachy stalowej kwasoodpornej 1.4404,
- silnik na inne niż standardowe napięcie oraz częstotliwość zasilania,
- silnik o innym stopniu ochrony,
- silnik o innej klasie izolacji,
- silnik wyposażony w czujniki lub dodatkowe chłodzenie,
- wentylator o średnicy powyżej 1250 mm.

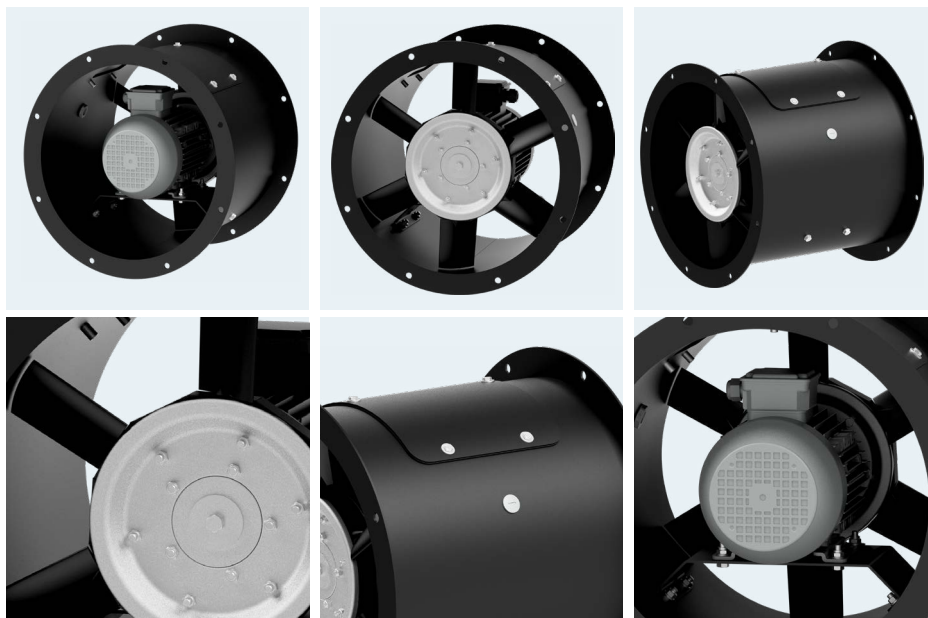

POWIĄZANE PRODUKTY

AFC-EC
Wersja z silnikiem EC

AFC-HT
Wersja wysoko-temperaturowa

AFC-VB
Napęd pasowy

AFD
do montażu ściennego

AFH
Silnik poza strumieniem powietrza

ARC
Tryb rewersyjny

EAC
Wersja przeciw-wybuchowa



DANE TECHNICZNE

model wentylatora	wydajność maksymalna	ciśnienie maksymalne	prędkość obrotowa	napięcie nominalne	natężenie znamionowe**	moc silnika	poziom ciśnienia akust.*	masa jednostki	numer artykułu
SILNIKI JEDNOFAZOWE DWUBIEGUNOWE									
AFC-402-075S	5 800 m ³ /h	480 Pa	2 880 rpm	1-230 V	4,2 A	0,75 kW	76 dB(A)	26,0 kg	430402071
AFC-402-110S	7 000 m ³ /h	490 Pa	2 900 rpm	1-230 V	5,8 A	1,1 kW	73 dB(A)	27,0 kg	430402111
AFC-452-110S	7 000 m ³ /h	550 Pa	2 900 rpm	1-230 V	5,8 A	1,1 kW	77 dB(A)	28,0 kg	430452111
SILNIKI TRÓJFAZOWE DWUBIEGUNOWE									
AFC-402-075T	5 800 m ³ /h	480 Pa	2 890 rpm	3-400 V	1,7 A	0,75 kW	76 dB(A)	26,0 kg	430402073
AFC-402-110T	7 000 m ³ /h	490 Pa	2 890 rpm	3-400 V	2,5 A	1,1 kW	73 dB(A)	27,0 kg	430402113
AFC-402-150T	8 450 m ³ /h	485 Pa	2 880 rpm	3-400 V	3,0 A	1,5 kW	72 dB(A)	32,0 kg	430402153
AFC-402-220T	9 300 m ³ /h	495 Pa	2 885 rpm	3-400 V	4,6 A	2,2 kW	73 dB(A)	35,0 kg	430402223
AFC-402-300T	10 500 m ³ /h	495 Pa	2 870 rpm	3-400 V	6,3 A	3,0 kW	74 dB(A)	36,0 kg	430402303
AFC-452-110T	7 000 m ³ /h	550 Pa	2 890 rpm	3-400 V	2,5 A	1,1 kW	77 dB(A)	28,0 kg	430452113
AFC-452-150T	8 900 m ³ /h	525 Pa	2 880 rpm	3-400 V	3,0 A	1,5 kW	74 dB(A)	34,0 kg	430452153
AFC-452-220T	10 900 m ³ /h	520 Pa	2 885 rpm	3-400 V	4,6 A	2,2 kW	73 dB(A)	37,0 kg	430452223
AFC-452-300T	13 300 m ³ /h	520 Pa	2 870 rpm	3-400 V	6,3 A	3,0 kW	74 dB(A)	38,0 kg	430452303
AFC-452-400T	14 600 m ³ /h	510 Pa	2 895 rpm	3-400 V	7,4 A	4,0 kW	74 dB(A)	50,0 kg	430452403
AFC-502-220T	8 950 m ³ /h	600 Pa	2 885 rpm	3-400 V	4,6 A	2,2 kW	79 dB(A)	46,0 kg	430502223
AFC-502-300T	11 500 m ³ /h	650 Pa	2 870 rpm	3-400 V	6,3 A	3,0 kW	78 dB(A)	47,0 kg	430502303
AFC-502-400T	14 200 m ³ /h	690 Pa	2 895 rpm	3-400 V	7,4 A	4,0 kW	76 dB(A)	61,0 kg	430502403
AFC-502-550T	16 600 m ³ /h	690 Pa	2 890 rpm	3-400 V	9,8 A	5,5 kW	77 dB(A)	71,0 kg	430502553
AFC-502-750T	19 300 m ³ /h	640 Pa	2 885 rpm	3-400 V	14,0 A	7,5 kW	78 dB(A)	72,0 kg	430502554
AFC-562-300T	13 700 m ³ /h	840 Pa	2 870 rpm	3-400 V	6,3 A	3,0 kW	83 dB(A)	49,0 kg	430562303
AFC-562-400T	16 900 m ³ /h	860 Pa	2 895 rpm	3-400 V	7,4 A	4,0 kW	81 dB(A)	67,0 kg	430562403
AFC-562-550T	21 100 m ³ /h	920 Pa	2 890 rpm	3-400 V	9,8 A	5,5 kW	80 dB(A)	75,0 kg	430562553
AFC-562-750T	24 000 m ³ /h	940 Pa	2 885 rpm	3-400 V	14,0 A	7,5 kW	80 dB(A)	75,0 kg	430562753
AFC-562-1100T	27 700 m ³ /h	950 Pa	2 900 rpm	3-400 V	19,1 A	11,0 kW	81 dB(A)	99,0 kg	430562813
AFC-632-400T	15 800 m ³ /h	830 Pa	2 895 rpm	3-400 V	7,4 A	4,0 kW	96 dB(A)	73,0 kg	430632403
AFC-632-550T	20 700 m ³ /h	930 Pa	2 890 rpm	3-400 V	9,8 A	5,5 kW	88 dB(A)	84,0 kg	430632553
AFC-632-750T	25 500 m ³ /h	1000 Pa	2 885 rpm	3-400 V	14,0 A	7,5 kW	84 dB(A)	84,0 kg	430632753
AFC-632-1100T	31 200 m ³ /h	1020 Pa	2 900 rpm	3-400 V	19,1 A	11,0 kW	83 dB(A)	102,0 kg	430632813

*pomiar wykonany w odległości 1,5m od wylotu, dla $\alpha = 2/3^{\circ} \alpha_{max}$

** wartość prądu znamionowego może się różnić w zależności od producenta zastosowanego silnika elektrycznego.



DANE TECHNICZNE

model wentylatora	wydajność maksymalna	ciśnienie maksymalne	prędkość obrotowa	napięcie nominalne	natężenie znamionowe**	moc silnika	poziom ciśnienia akust.*	masa jednostki	numer artykułu
AFC-632-1500T	37 600 m ³ /h	970 Pa	2 940 rpm	3~400 V	26,2 A	15,0 kW	85 dB(A)	142,0 kg	430632853
SILNIKI TRÓJFAZOWE CZTEROBIEGUNOWE									
AFC-564-037T	6 850 m ³ /h	230 Pa	1 410 rpm	3~400 V	1,1 A	0,37 kW	68 dB(A)	36,0 kg	430564033
AFC-564-055T	8 450 m ³ /h	235 Pa	1 420 rpm	3~400 V	1,6 A	0,55 kW	66 dB(A)	38,0 kg	430564053
AFC-564-075T	10 500 m ³ /h	250 Pa	1 430 rpm	3~400 V	2,1 A	0,75 kW	66 dB(A)	40,0 kg	430564073
AFC-564-110T	12 000 m ³ /h	250 Pa	1 425 rpm	3~400 V	2,5 A	1,1 kW	65 dB(A)	48,0 kg	430564113
AFC-564-150T	13 900 m ³ /h	240 Pa	1 440 rpm	3~400 V	3,6 A	1,5 kW	66 dB(A)	49,0 kg	430564153
AFC-634-055T	7 900 m ³ /h	245 Pa	1 420 rpm	3~400 V	1,6 A	0,55 kW	79 dB(A)	45,0 kg	430634053
AFC-634-075T	10 300 m ³ /h	265 Pa	1 430 rpm	3~400 V	2,1 A	0,75 kW	73 dB(A)	47,0 kg	430634073
AFC-634-110T	12 800 m ³ /h	250 Pa	1 425 rpm	3~400 V	2,5 A	1,1 kW	69 dB(A)	47,0 kg	430634113
AFC-634-150T	15 600 m ³ /h	260 Pa	1 440 rpm	3~400 V	3,6 A	1,5 kW	68 dB(A)	57,0 kg	430634153
AFC-634-220T	18 800 m ³ /h	245 Pa	1 450 rpm	3~400 V	4,6 A	2,2 kW	70 dB(A)	73,0 kg	430634223
AFC-714-110T	12 900 m ³ /h	370 Pa	1 425 rpm	3~400 V	2,5 A	1,1 kW	77 dB(A)	61,0 kg	430714113
AFC-714-150T	15 400 m ³ /h	380 Pa	1 440 rpm	3~400 V	3,6 A	1,5 kW	76 dB(A)	62,0 kg	430714153
AFC-714-220T	20 400 m ³ /h	390 Pa	1 450 rpm	3~400 V	4,6 A	2,2 kW	76 dB(A)	73,0 kg	430714223
AFC-714-300T	24 700 m ³ /h	375 Pa	1 460 rpm	3~400 V	6,7 A	3,0 kW	73 dB(A)	73,0 kg	430714303
AFC-714-400T	28 600 m ³ /h	325 Pa	1 450 rpm	3~400 V	8,4 A	4,0 kW	74 dB(A)	87,0 kg	430714403
AFC-804-150T	17 400 m ³ /h	430 Pa	1 440 rpm	3~400 V	3,6 A	1,5 kW	76 dB(A)	74,0 kg	430804153
AFC-804-220T	21 300 m ³ /h	480 Pa	1 450 rpm	3~400 V	4,6 A	2,2 kW	76 dB(A)	91,0 kg	430804223
AFC-804-300T	24 400 m ³ /h	520 Pa	1 460 rpm	3~400 V	6,7 A	3,0 kW	76 dB(A)	91,0 kg	430804303
AFC-804-400T	28 100 m ³ /h	530 Pa	1 450 rpm	3~400 V	8,4 A	4,0 kW	76 dB(A)	100,0 kg	430804403
AFC-804-550T	33 900 m ³ /h	440 Pa	1 460 rpm	3~400 V	10,8 A	5,5 kW	78 dB(A)	112,0 kg	430804553
AFC-904-300T	26 400 m ³ /h	600 Pa	1 460 rpm	3~400 V	6,7 A	3,0 kW	85 dB(A)	102,0 kg	430904303
AFC-904-400T	30 900 m ³ /h	600 Pa	1 450 rpm	3~400 V	8,4 A	4,0 kW	84 dB(A)	110,0 kg	430904403
AFC-904-550T	37 000 m ³ /h	600 Pa	1 460 rpm	3~400 V	10,8 A	5,5 kW	84 dB(A)	134,0 kg	430904553
AFC-904-750T	44 300 m ³ /h	605 Pa	1 450 rpm	3~400 V	14,6 A	7,5 kW	83 dB(A)	143,0 kg	430904753
AFC-904-1100T	55 300 m ³ /h	530 Pa	1 475 rpm	3~400 V	21,2 A	11,0 kW	82 dB(A)	176,0 kg	430904813
AFC-1004-550T	32 000 m ³ /h	920 Pa	1 460 rpm	3~400 V	10,8 A	5,5 kW	94 dB(A)	140,0 kg	431004553
AFC-1004-750T	42 100 m ³ /h	790 Pa	1 450 rpm	3~400 V	14,6 A	7,5 kW	93 dB(A)	149,0 kg	431004753
AFC-1004-1100T	52 200 m ³ /h	795 Pa	1 475 rpm	3~400 V	21,2 A	11,0 kW	91 dB(A)	197,0 kg	431004813
AFC-1004-1500T	61 500 m ³ /h	660 Pa	1 475 rpm	3~400 V	28,3 A	15,0 kW	89 dB(A)	208,0 kg	431004853
AFC-1004-1850T	68 500 m ³ /h	660 Pa	1 475 rpm	3~400 V	34,7 A	18,5 kW	88 dB(A)	223,0 kg	431004883
AFC-1124-1100T	57 800 m ³ /h	970 Pa	1 475 rpm	3~400 V	21,2 A	11,0 kW	92 dB(A)	251,0 kg	431124813
AFC-1124-1500T	70 200 m ³ /h	900 Pa	1 475 rpm	3~400 V	28,3 A	15,0 kW	89 dB(A)	262,0 kg	431124853
AFC-1124-1850T	80 200 m ³ /h	850 Pa	1 475 rpm	3~400 V	34,7 A	18,5 kW	87 dB(A)	277,0 kg	431124883
AFC-1124-2200T	87 600 m ³ /h	840 Pa	1 470 rpm	3~400 V	41,1 A	22,0 kW	87 dB(A)	295,0 kg	431124923
AFC-1124-3000T	105 000 m ³ /h	685 Pa	1 470 rpm	3~400 V	54,0 A	30,0 kW	86 dB(A)	470,0 kg	431124903
AFC-1254-1850T	67 000 m ³ /h	1330 Pa	1 475 rpm	3~400 V	34,7 A	18,5 kW	94 dB(A)	305,0 kg	431254883
AFC-1254-2200T	79 100 m ³ /h	1250 Pa	1 470 rpm	3~400 V	41,1 A	22,0 kW	93 dB(A)	323,0 kg	431254923
AFC-1254-3000T	99 300 m ³ /h	1130 Pa	1 470 rpm	3~400 V	54,0 A	30,0 kW	90 dB(A)	517,0 kg	431254903
AFC-1254-3700T	116 000 m ³ /h	1100 Pa	1 485 rpm	3~400 V	65,0 A	37,0 kW	90 dB(A)	620,0 kg	431254973
AFC-1254-4500T	127 000 m ³ /h	940 Pa	1 485 rpm	3~400 V	78,0 A	45,0 kW	89 dB(A)	657,0 kg	431254953

*pomiar wykonany w odległości 1,5m od wylotu, dla $\alpha = 2/3^{\circ} \alpha_{max}$

** wartość prądu znamionowego może się różnić w zależności od producenta zastosowanego silnika elektrycznego.



CHARAKTERYSTYKI PRACY WENTYLATORÓW - Silniki dwubiegunowe

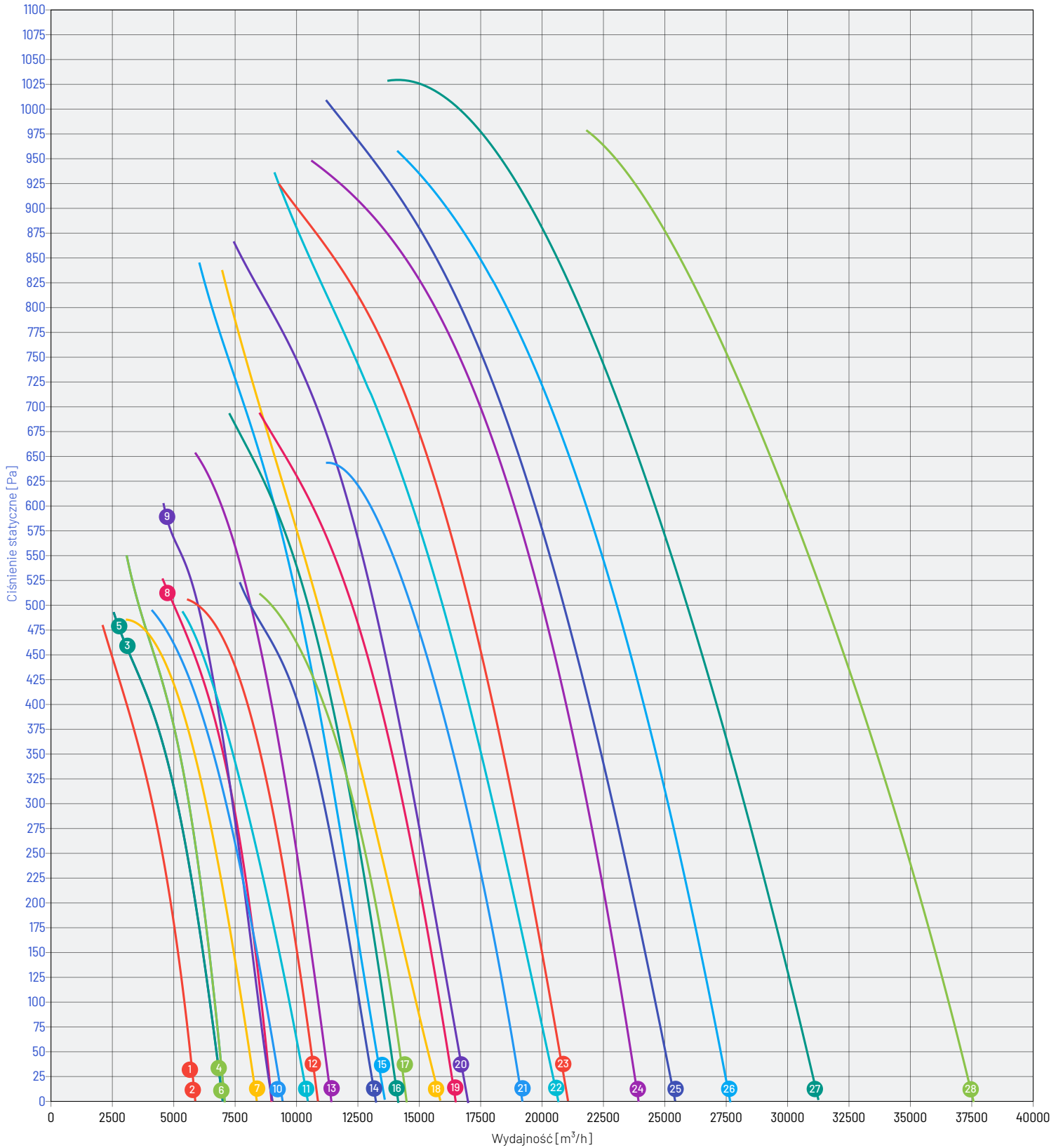

- | | | | | | | | |
|-----------------|------------------|------------------|------------------|-----------------|-----------------|-----------------|-----------------|
| 1 AFC-402-075S | 2 AFC-402-075T | 3 AFC-402-110S | 4 AFC-452-110S | 5 AFC-402-110T | 6 AFC-452-110T | 7 AFC-402-150T | 8 AFC-452-150T |
| 9 AFC-502-220T | 10 AFC-402-220T | 11 AFC-402-300T | 12 AFC-452-220T | 13 AFC-502-300T | 14 AFC-452-300T | 15 AFC-562-300T | 16 AFC-502-400T |
| 17 AFC-452-400T | 18 AFC-632-400T | 19 AFC-502-550T | 20 AFC-562-400T | 21 AFC-502-750T | 22 AFC-632-550T | 23 AFC-562-550T | 24 AFC-562-750T |
| 25 AFC-632-750T | 26 AFC-562-1100T | 27 AFC-632-1100T | 28 AFC-632-1500T | | | | |



CHARAKTERYSTYKI PRACY WENTYLATORÓW - Silniki czterobiegunowe

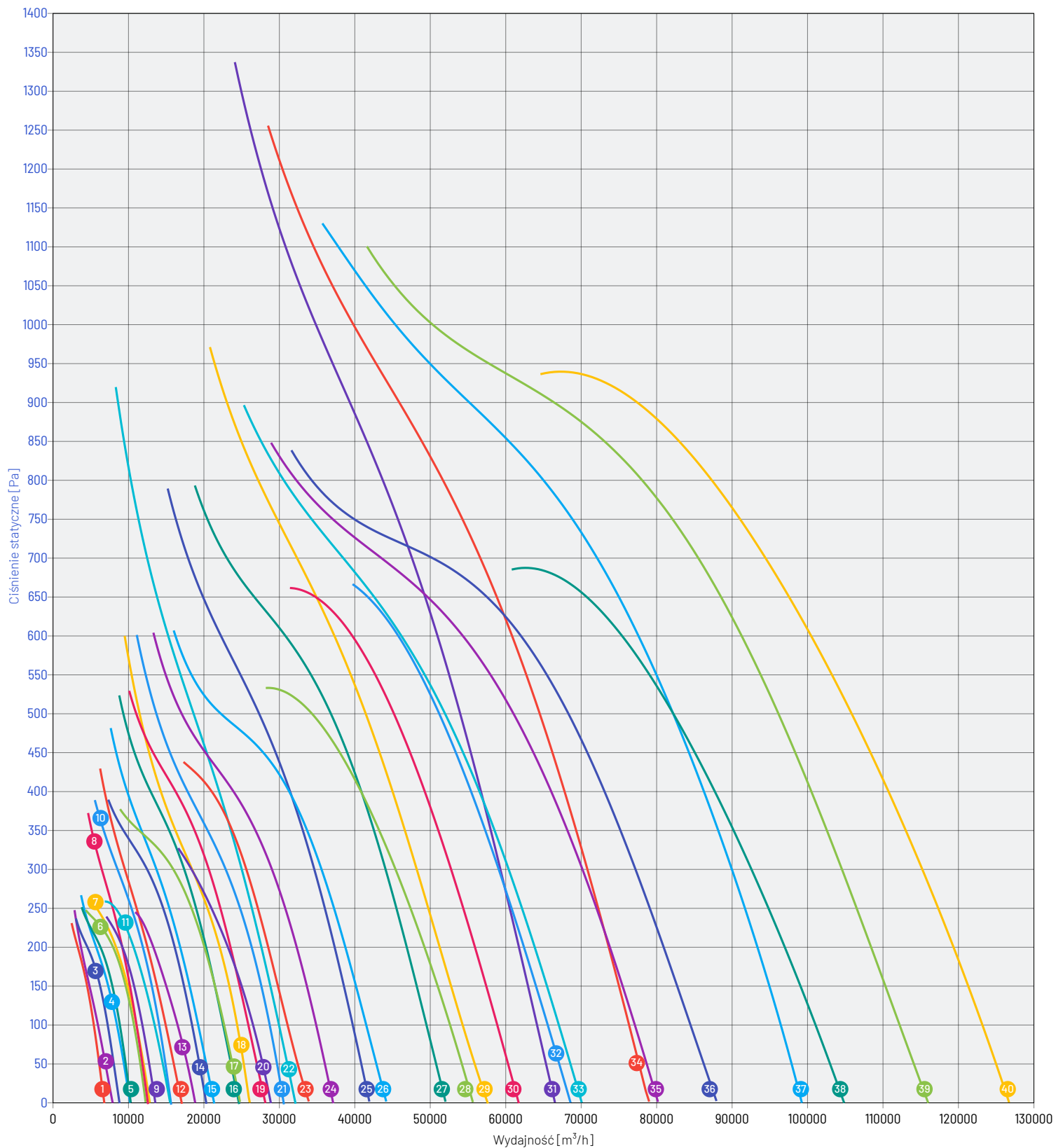

- | | | | | | | | |
|-------------------|-------------------|-------------------|-------------------|-------------------|-------------------|-------------------|-------------------|
| 1 AFC-564-037T | 2 AFC-634-055T | 3 AFC-564-055T | 4 AFC-634-075T | 5 AFC-564-075T | 6 AFC-564-110T | 7 AFC-634-110T | 8 AFC-714-110T |
| 9 AFC-564-150T | 10 AFC-714-150T | 11 AFC-634-150T | 12 AFC-804-150T | 13 AFC-634-220T | 14 AFC-714-220T | 15 AFC-804-220T | 16 AFC-804-300T |
| 17 AFC-714-300T | 18 AFC-904-300T | 19 AFC-804-400T | 20 AFC-714-400T | 21 AFC-904-400T | 22 AFC-1004-550T | 23 AFC-804-550T | 24 AFC-904-550T |
| 25 AFC-1004-750T | 26 AFC-904-750T | 27 AFC-1004-1100T | 28 AFC-904-1100T | 29 AFC-1124-1100T | 30 AFC-1004-1500T | 31 AFC-1254-1850T | 32 AFC-1004-1850T |
| 33 AFC-1124-1500T | 34 AFC-1254-2200T | 35 AFC-1124-1850T | 36 AFC-1124-2200T | 37 AFC-1254-3000T | 38 AFC-1124-3000T | 39 AFC-1254-3700T | 40 AFC-1254-4500T |

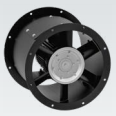

CHARAKTERYSTYKI PRACY

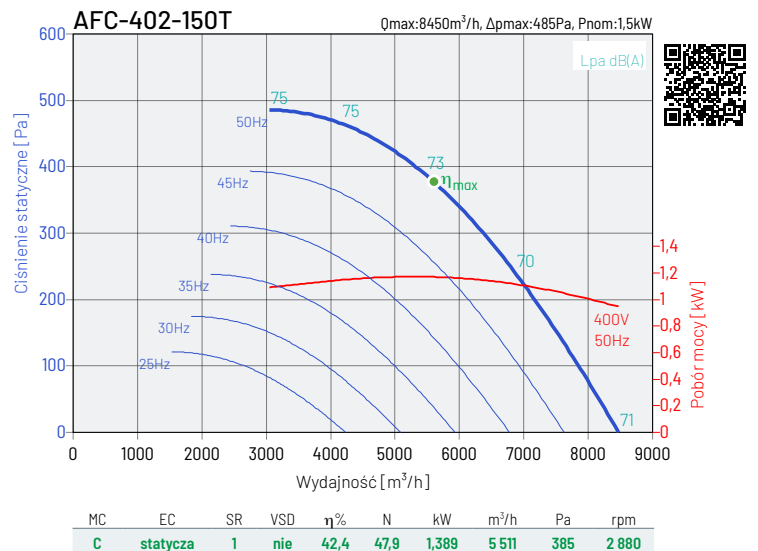
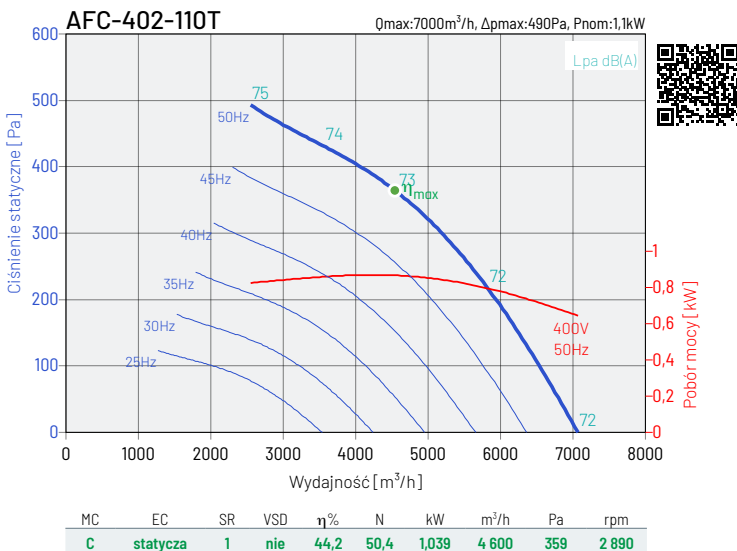
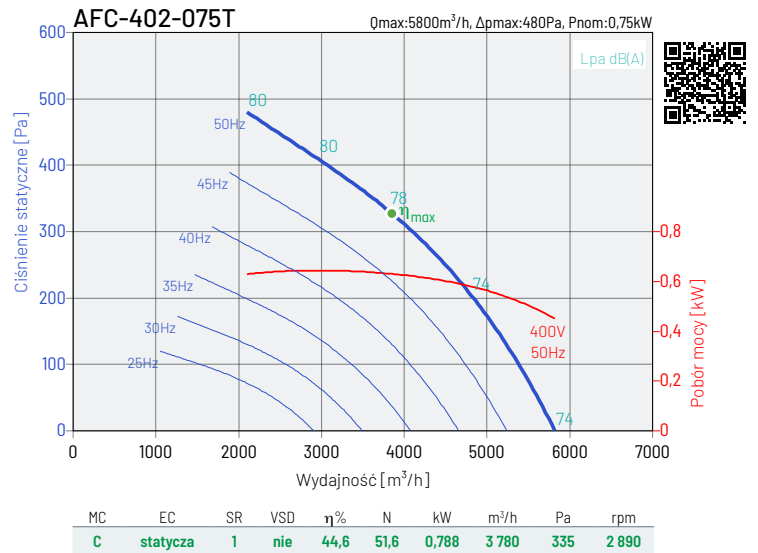
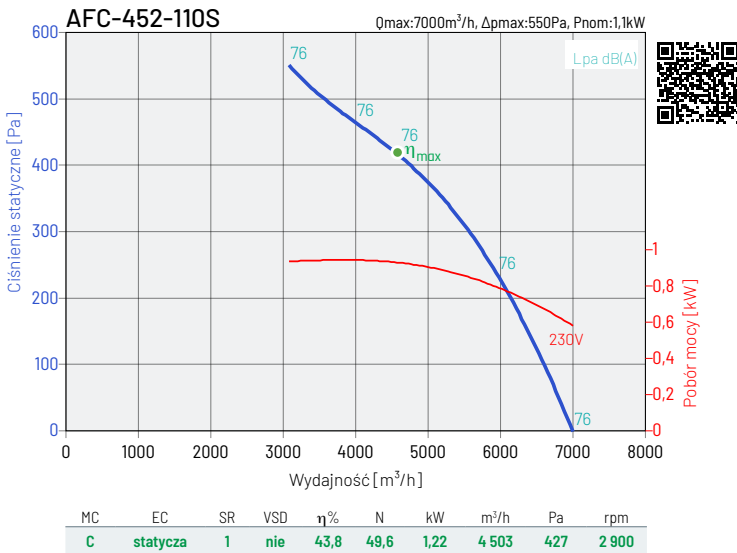
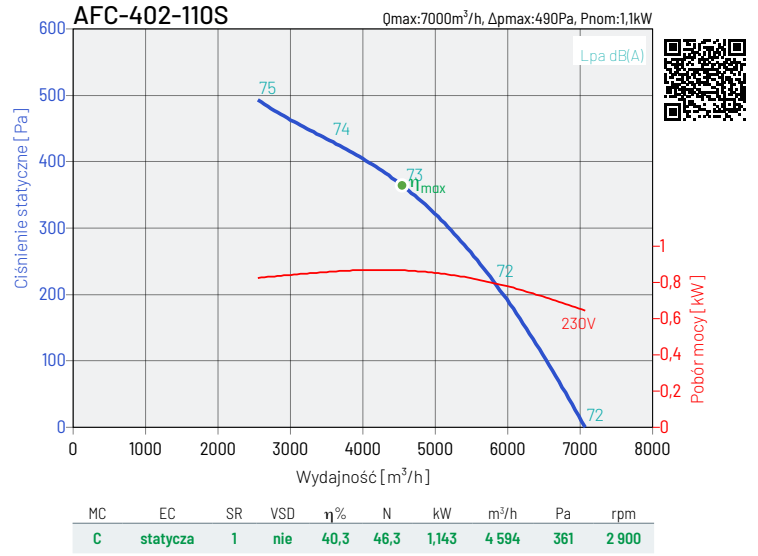
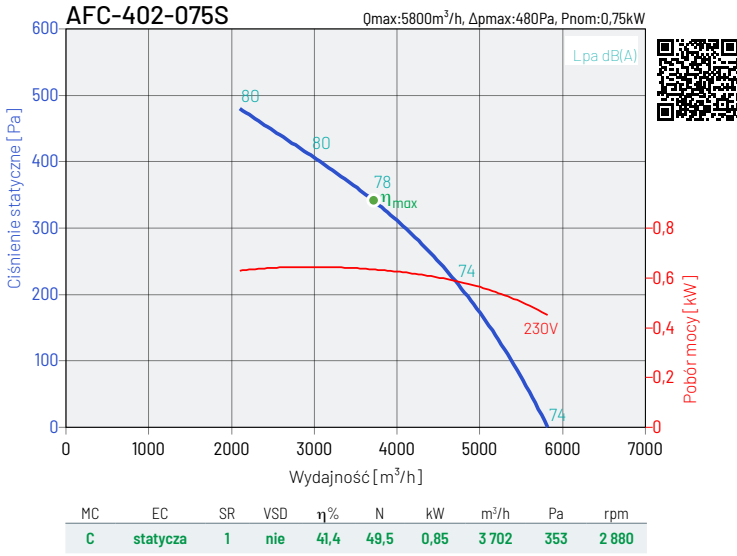

Charakterystyki pracy wentylatorów wyznaczone dla medium o temperaturze 20°C i ciśnieniu atmosferycznych 1013,25hPa. Poziom ciśnienia akustycznego dB(A), wyznaczany w odległości 1,5m

Dyrektywa ErP:

MC-Kategoria pomiarowa, EC-Kategoria sprawności, SR-Ilość biegów, VSD-Regulacja prędkości, η%-Sprawność maksymalna, N-Współczynnik sprawności, kW-Pobór mocy, m³/h-Wydajność, Pa-Ciśnienie, RPM-Prędkość obrotowa



CHARAKTERYSTYKI PRACY

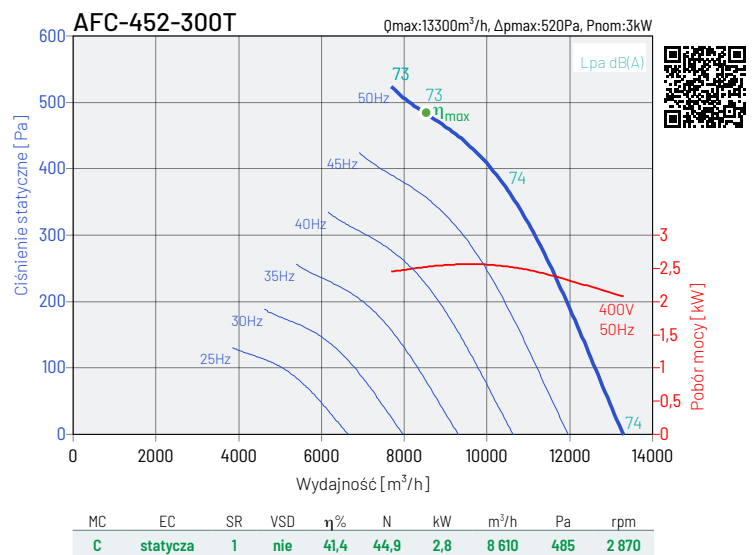
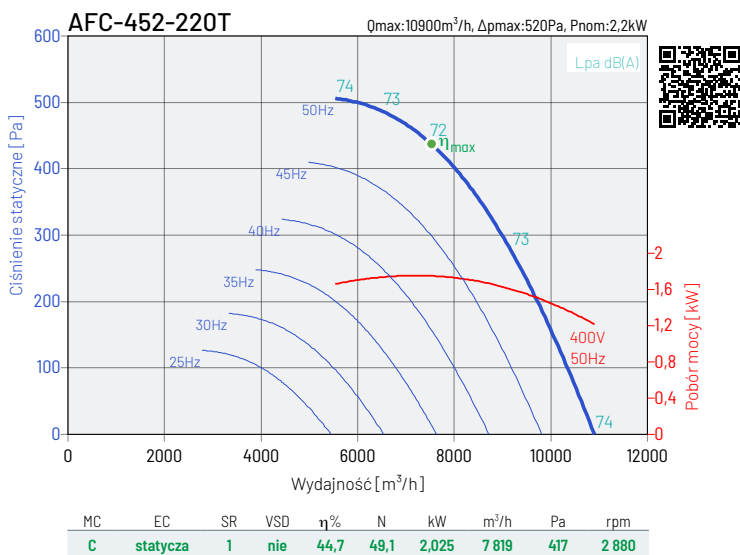
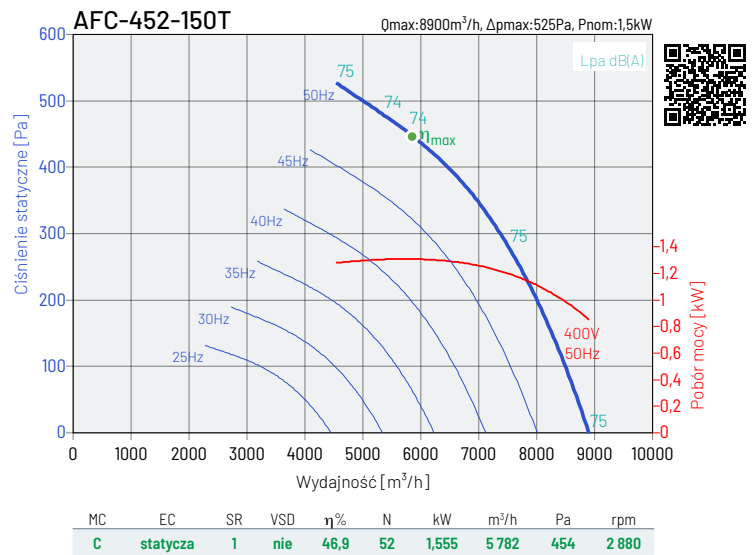
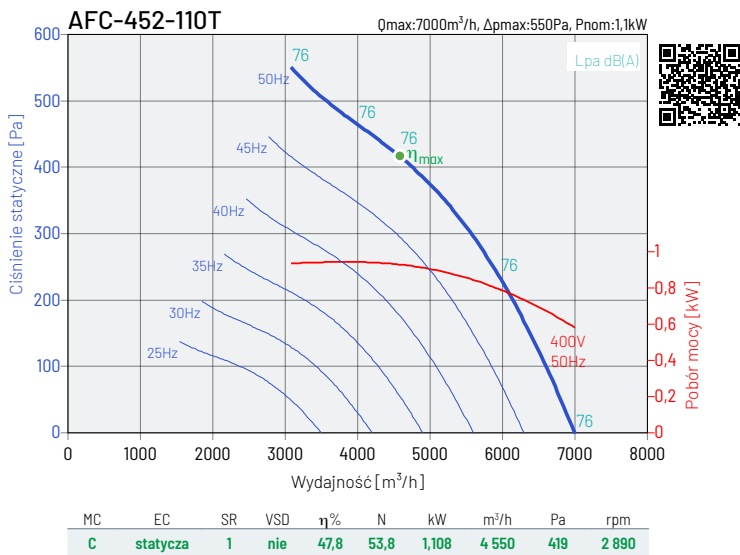
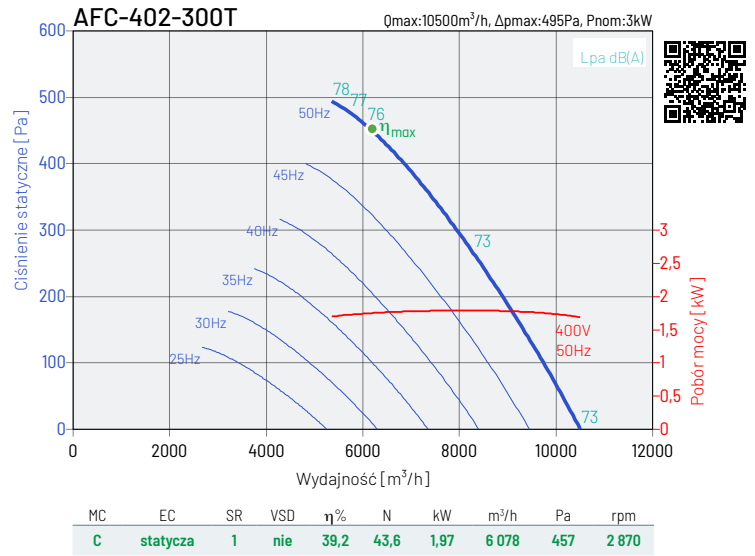
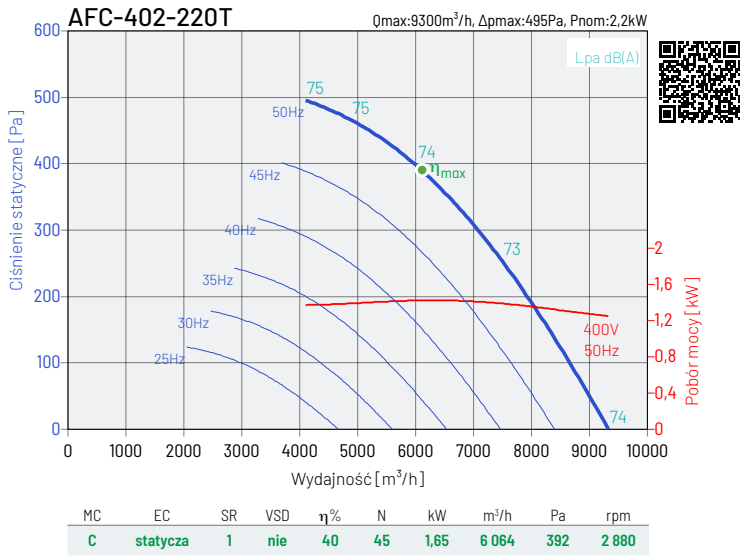

Charakterystyki pracy wentylatorów wyznaczone dla medium o temperaturze 20°C i ciśnieniu atmosferycznych 1013,25hPa. Poziom ciśnienia akustycznego dB(A), wyznaczany w odległości 1,5m

Dyrektywa ErP:

MC-Kategoria pomiarowa, EC-Kategoria sprawności, SR-Ilość biegów, VSD-Regulacja prędkości, $\eta\%$ -Sprawność maksymalna, N-Współczynnik sprawności, kW-Pobór mocy, m^3/h -Wydajność, Pa-Ciśnienie, RPM-Prędkość obrotowa



CHARAKTERYSTYKI PRACY

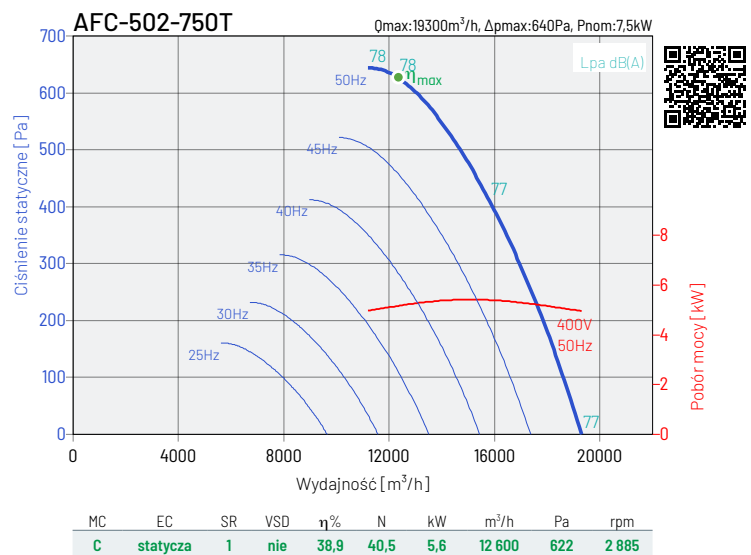
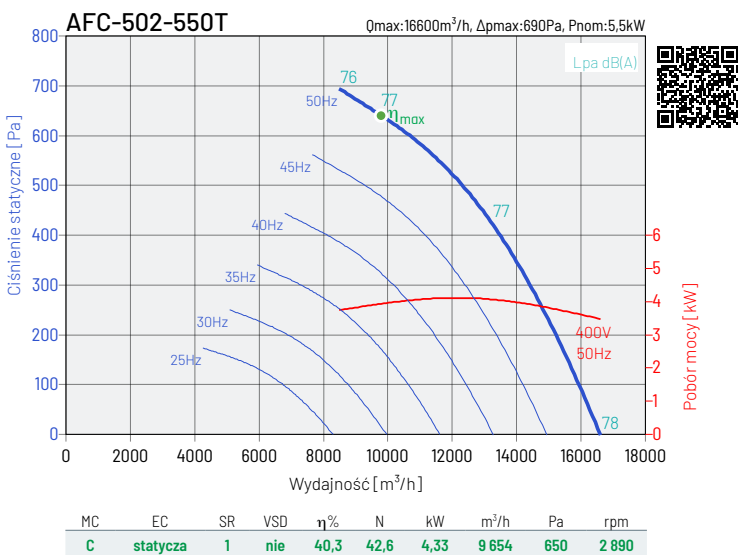
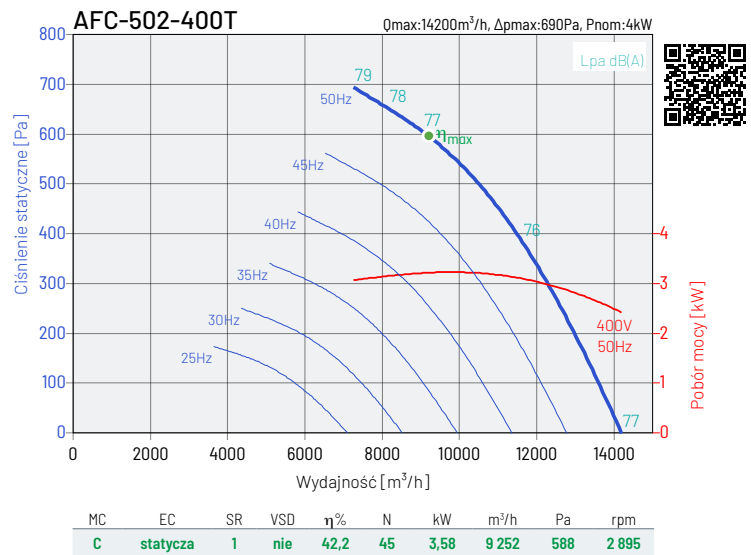
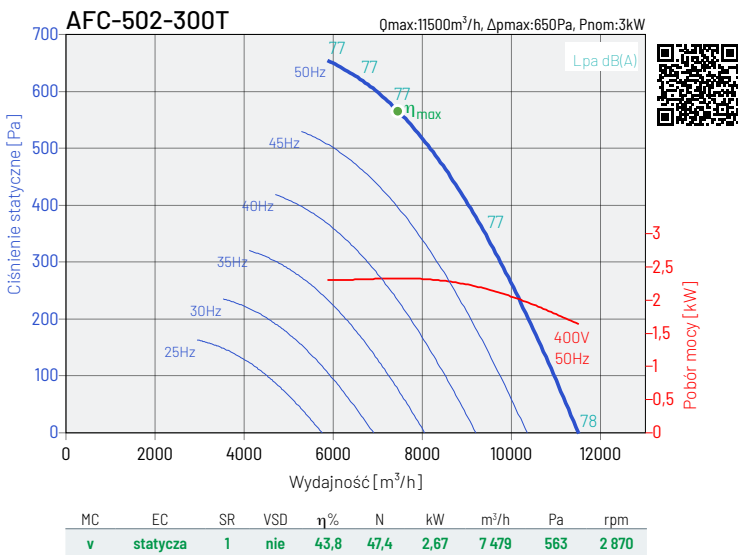
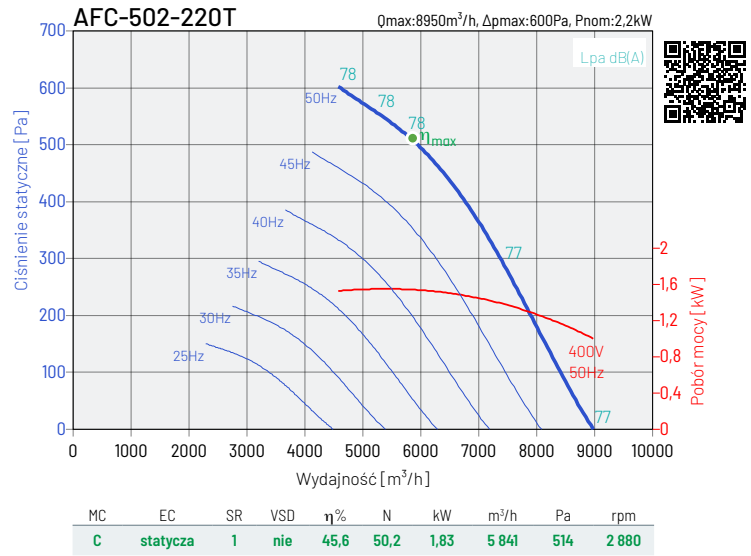
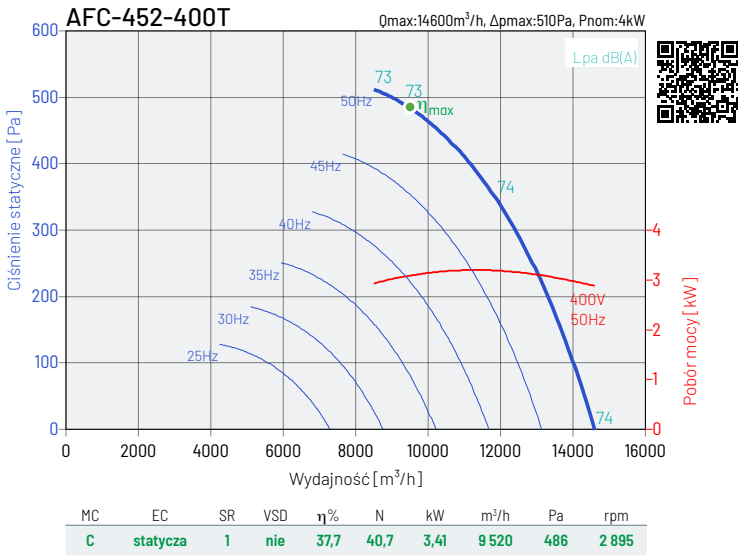

Charakterystyki pracy wentylatorów wyznaczone dla medium o temperaturze 20°C i ciśnieniu atmosferycznych 1013,25hPa. Poziom ciśnienia akustycznego dB(A), wyznaczany w odległości 1,5m

Dyrektywa ErP:

MC-Kategoria pomiarowa, EC-Kategoria sprawności, SR-Ilość biegów, VSD-Regulacja prędkości, η%-Sprawność maksymalna, N-Współczynnik sprawności, kW-Pobór mocy, m³/h-Wydajność, Pa-Ciśnienie, RPM-Prędkość obrotowa



CHARAKTERYSTYKI PRACY

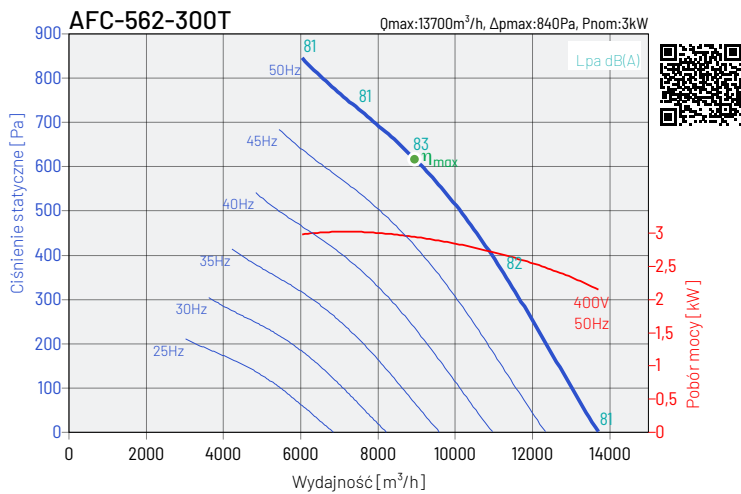

MC	EC	SR	VSD	η%	N	kW	m ³ /h	Pa	rpm
C	statyczna	1	nie	46,4	49,4	3,3	8 930	617	2 870

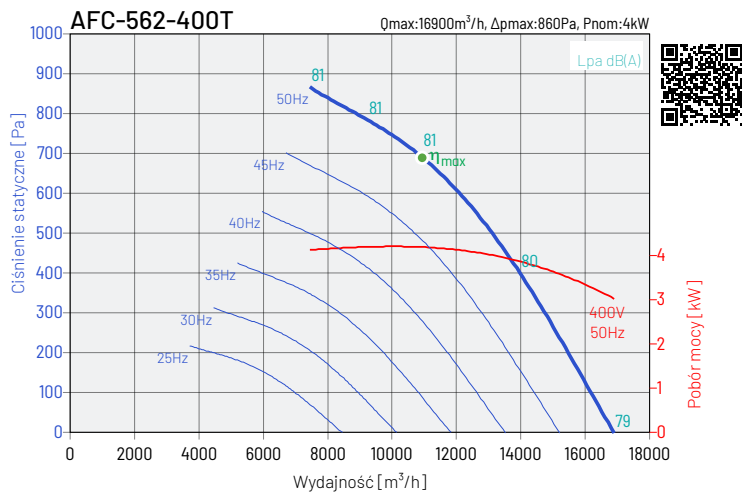

MC	EC	SR	VSD	η%	N	kW	m ³ /h	Pa	rpm
C	statyczna	1	nie	44,4	46,5	4,67	11 005	678	2 895

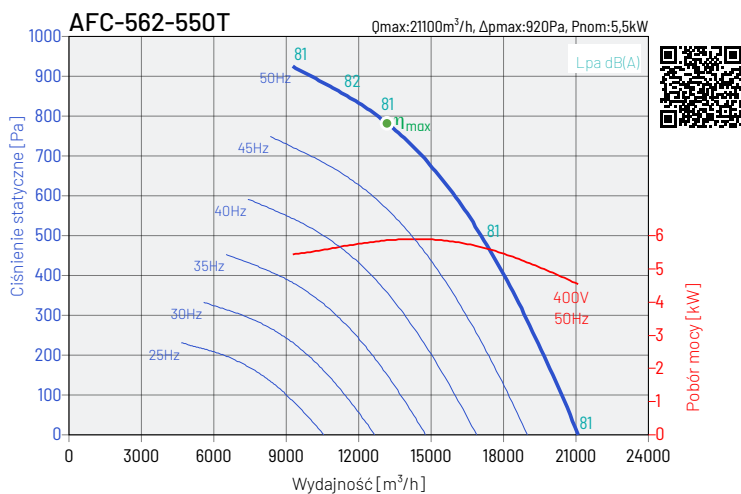

MC	EC	SR	VSD	η%	N	kW	m ³ /h	Pa	rpm
C	statyczna	1	nie	44,8	46	6,4	13 702	753	2 890

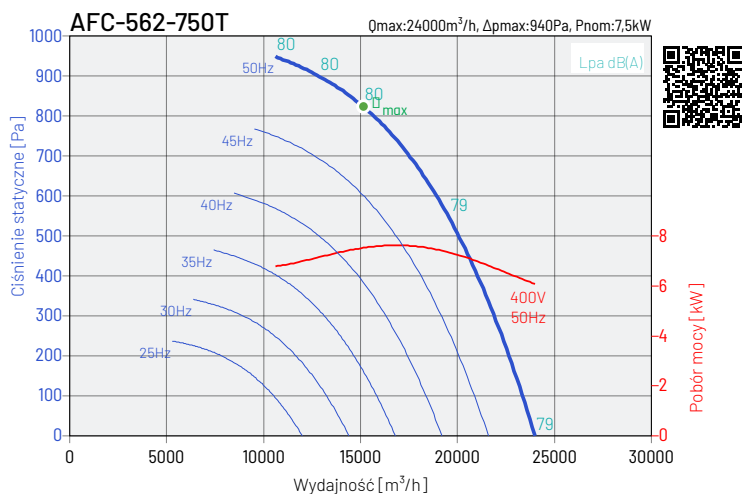

MC	EC	SR	VSD	η%	N	kW	m ³ /h	Pa	rpm
C	statyczna	1	nie	42,6	43,3	7,9	13 905	871	2 885

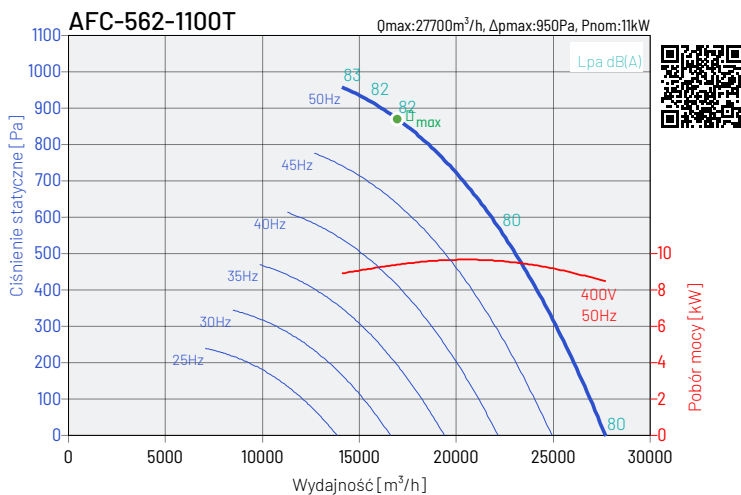

MC	EC	SR	VSD	η%	N	kW	m ³ /h	Pa	rpm
C	statyczna	1	nie	40,5	40,5	10,01	16 108	905	2 900

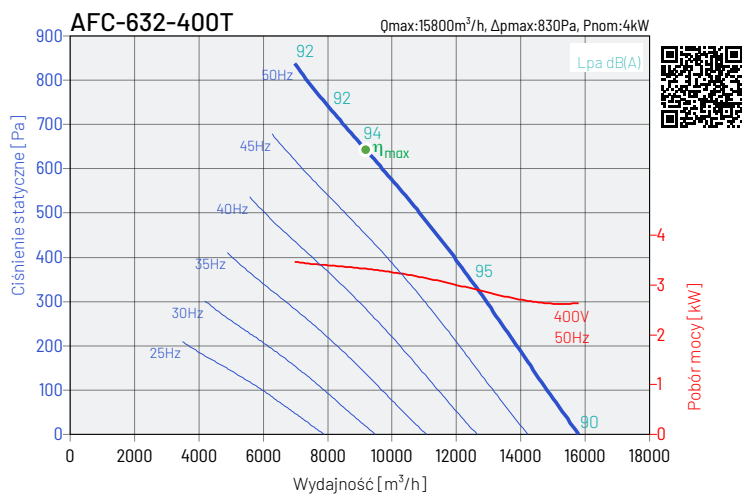

MC	EC	SR	VSD	η%	N	kW	m ³ /h	Pa	rpm
C	statyczna	1	nie	45	47,8	3,666	9 190	646	2 895

Charakterystyki pracy wentylatorów wyznaczone dla medium o temperaturze 20°C i ciśnieniu atmosferycznych 1013,25hPa. Poziom ciśnienia akustycznego dB(A), wyznaczany w odległości 1,5m

Dyrektywa ErP:

MC-Kategoria pomiarowa, EC-Kategoria sprawności, SR-Ilość biegów, VSD-Regulacja prędkości, η%-Sprawność maksymalna, N-Współczynnik sprawności, kW-Pobór mocy, m³/h-Wydajność, Pa-Ciśnienie, RPM-Prędkość obrotowa



CHARAKTERYSTYKI PRACY

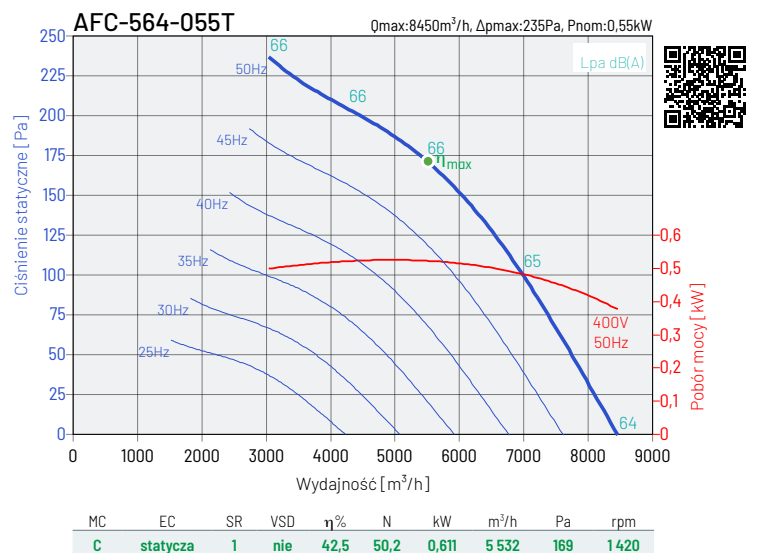
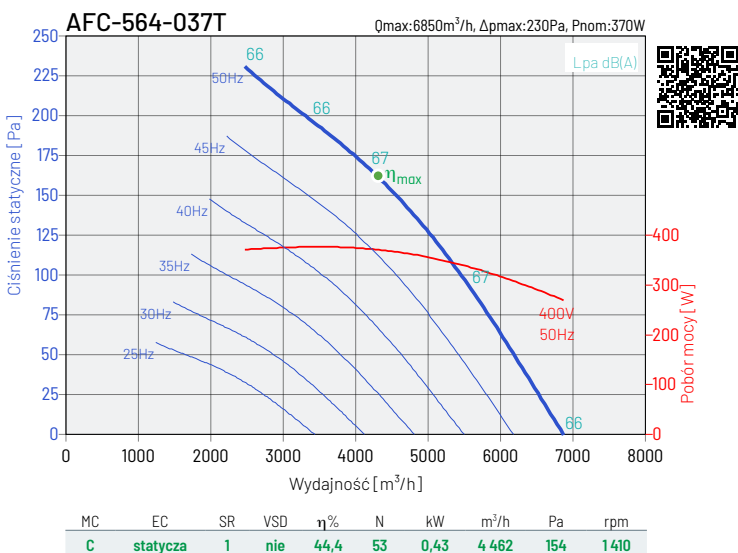
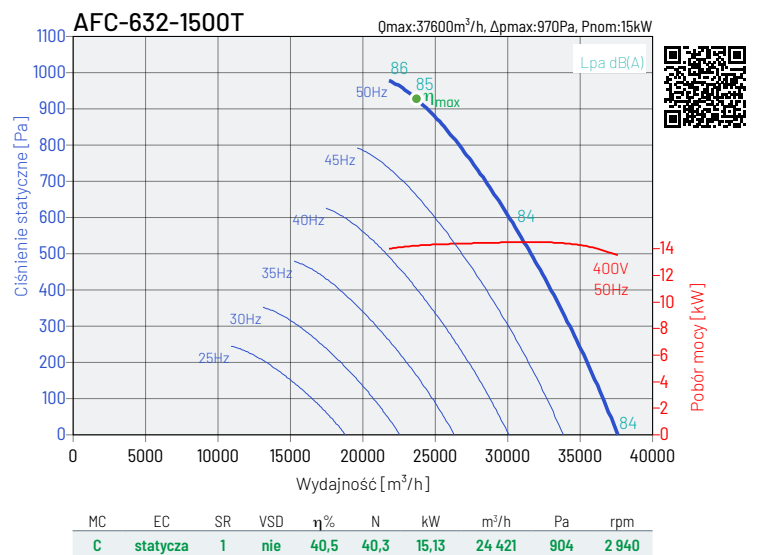
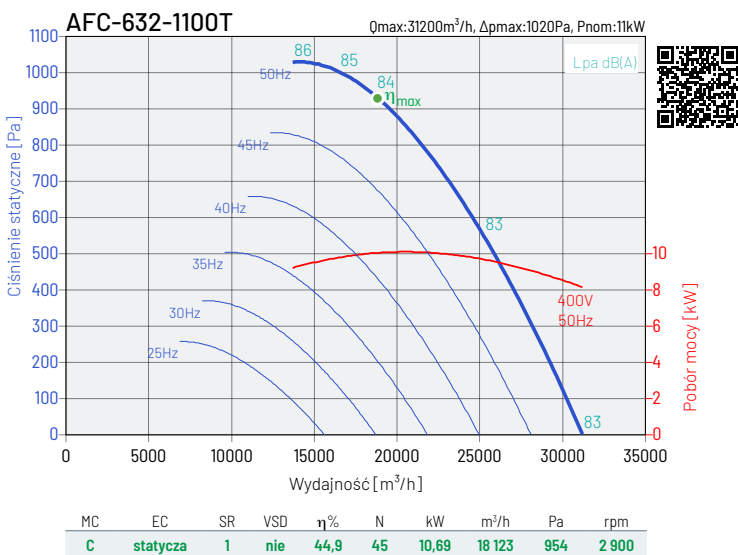
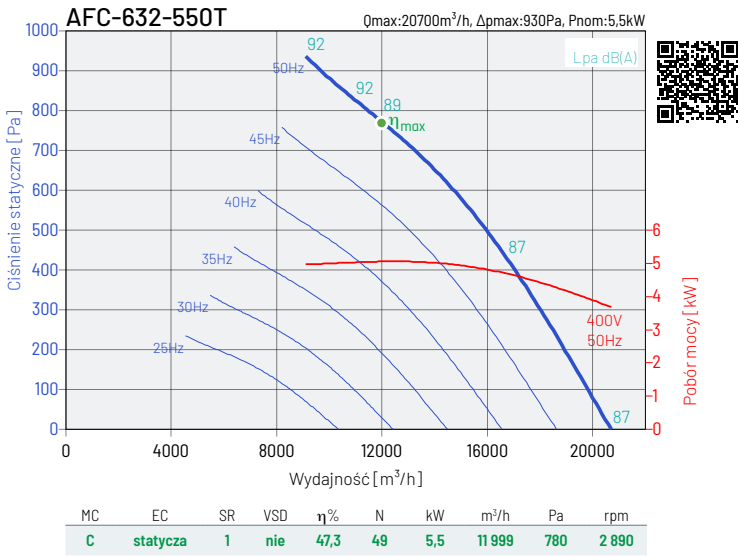

Charakterystyki pracy wentylatorów wyznaczone dla medium o temperaturze 20°C i ciśnieniu atmosferycznych 1013,25hPa. Poziom ciśnienia akustycznego dB(A), wyznaczany w odległości 1,5m

Dyrektywa ErP:

MC-Kategoria pomiarowa, EC-Kategoria sprawności, SR-Ilość biegów, VSD-Regulacja prędkości, η%-Sprawność maksymalna, N-Współczynnik sprawności, kW-Pobór mocy, m³/h-Wydajność, Pa-Ciśnienie, RPM-Prędkość obrotowa



CHARAKTERYSTYKI PRACY

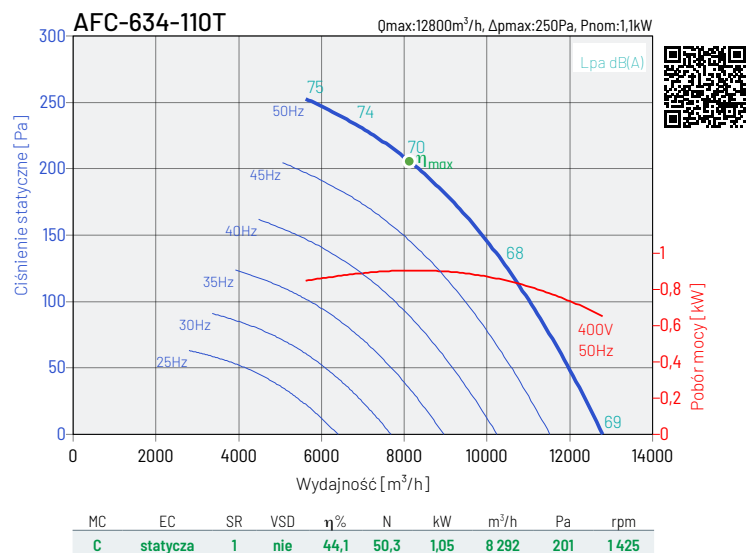
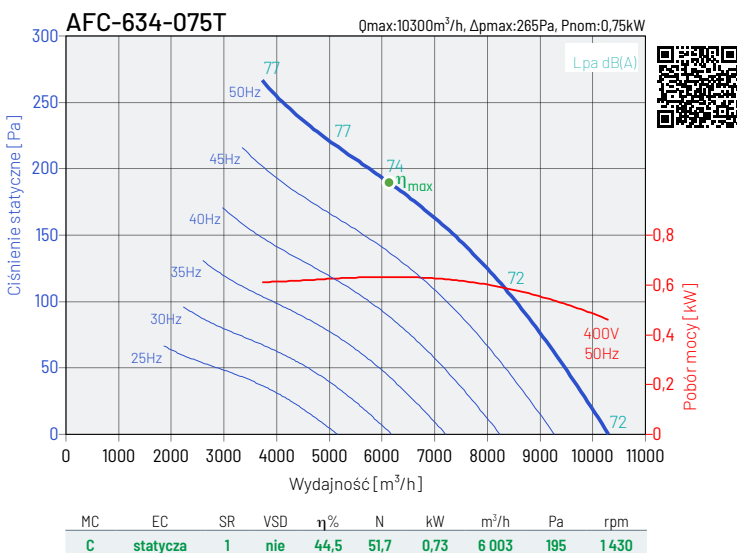
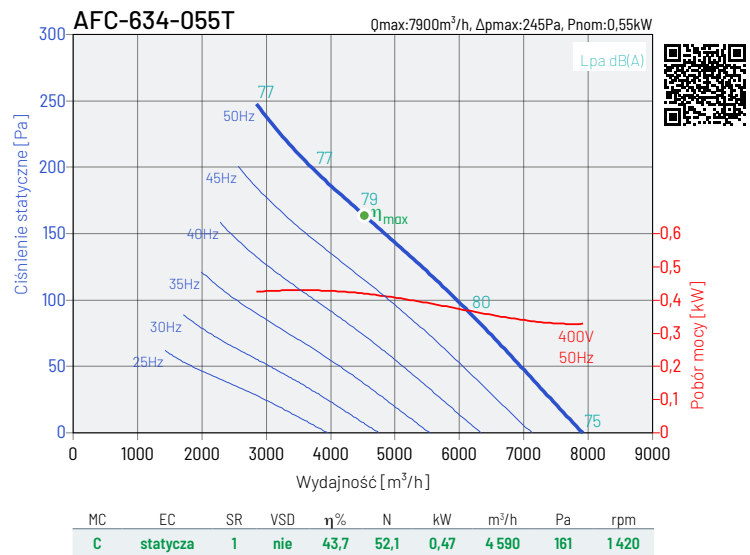
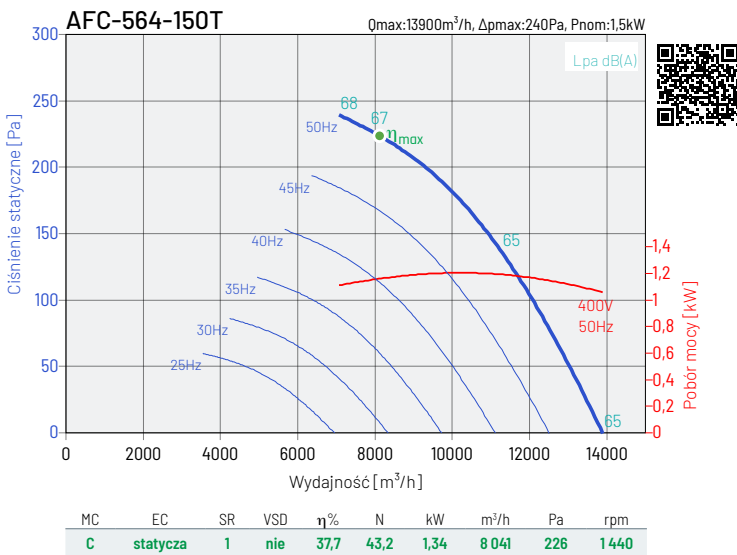
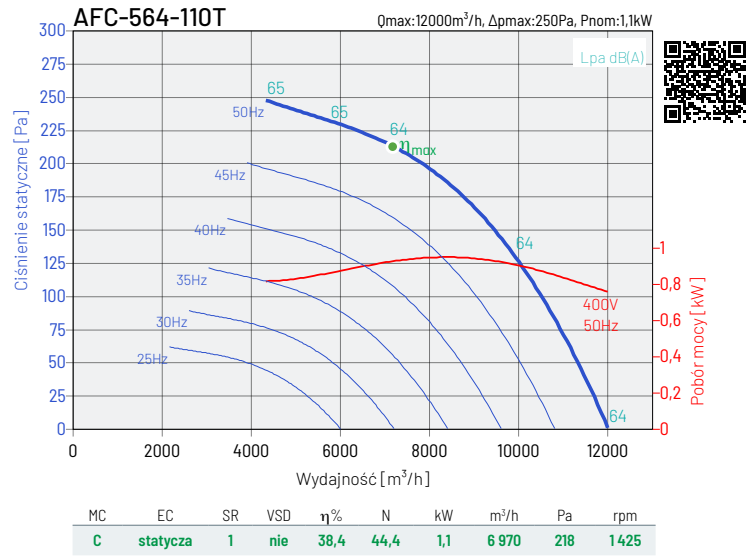
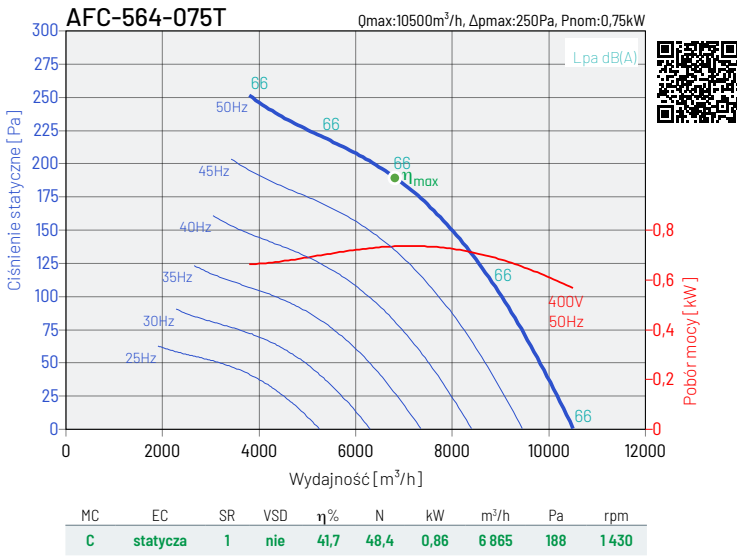

Charakterystyki pracy wentylatorów wyznaczone dla medium o temperaturze 20°C i ciśnieniu atmosferycznych 1013,25hPa. Poziom ciśnienia akustycznego dB(A), wyznaczany w odległości 1,5m

Dyrektywa ErP:

MC-Kategoria pomiarowa, EC-Kategoria sprawności, SR-Ilość biegów, VSD-Regulacja prędkości, $\eta\%$ -Sprawność maksymalna, N-Współczynnik sprawności, kW-Pobór mocy, m^3/h -Wydajność, Pa-Ciśnienie, RPM-Prędkość obrotowa



CHARAKTERYSTYKI PRACY

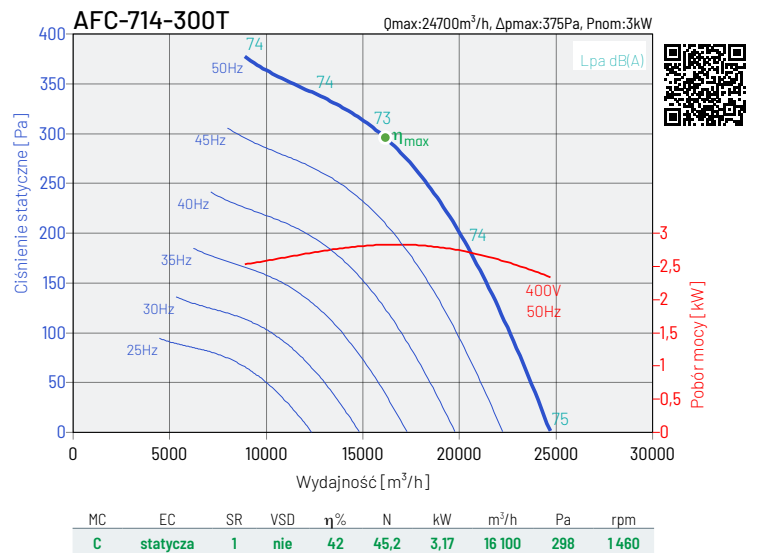
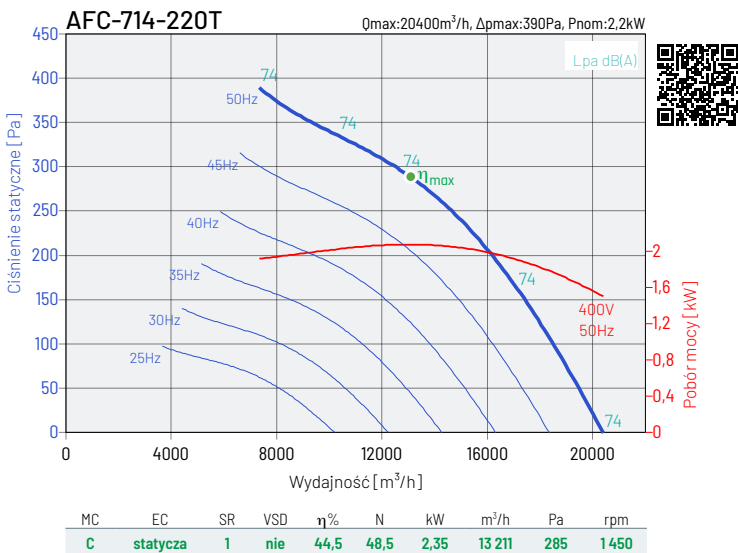
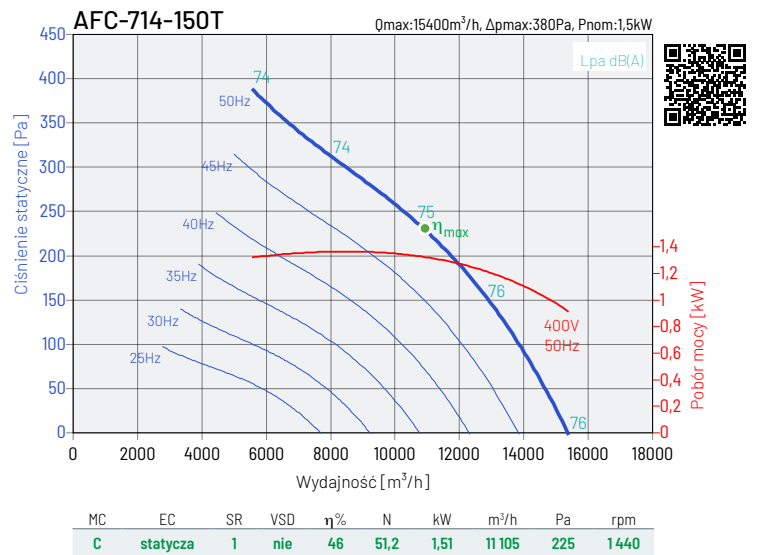
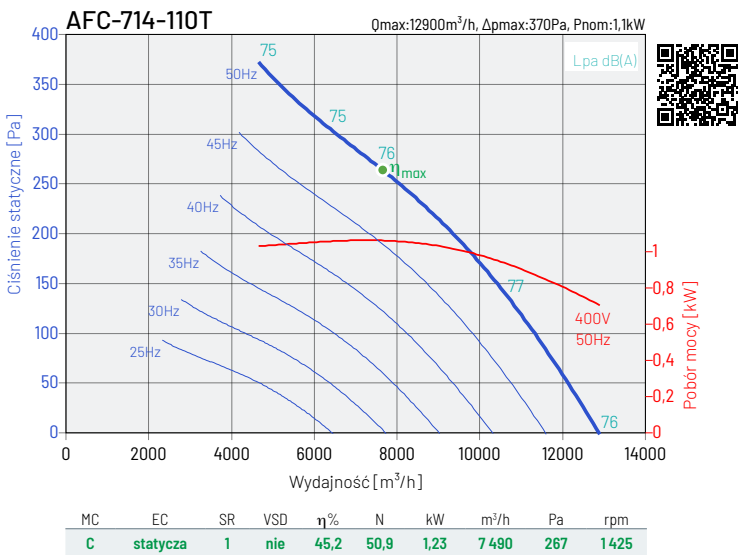
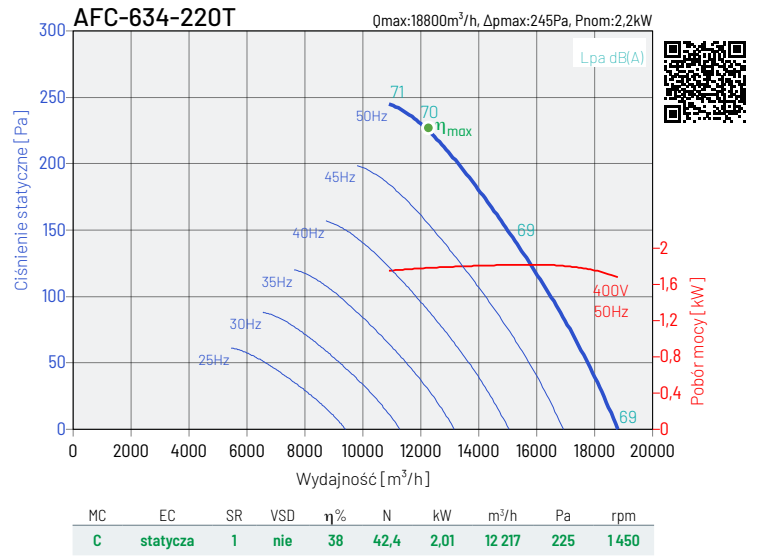
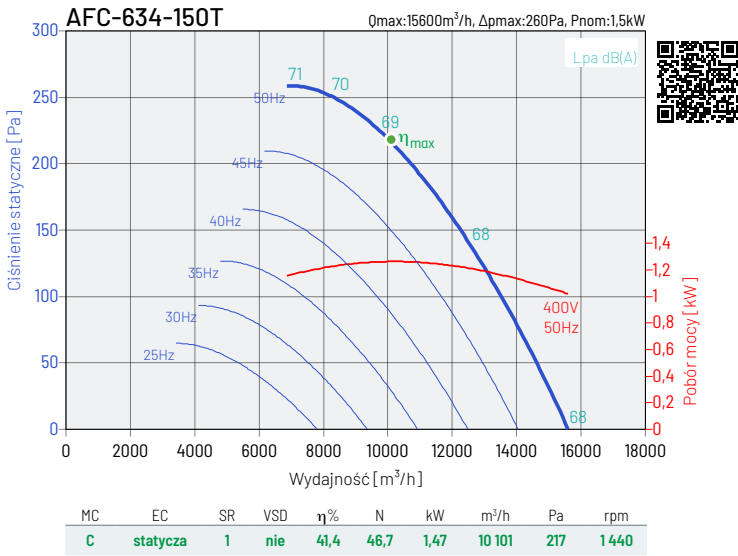

Charakterystyki pracy wentylatorów wyznaczone dla medium o temperaturze 20°C i ciśnieniu atmosferycznych 1013,25hPa. Poziom ciśnienia akustycznego dB(A), wyznaczany w odległości 1,5m

Dyrektywa ErP:

MC-Kategoria pomiarowa, EC-Kategoria sprawności, SR-Ilość biegów, VSD-Regulacja prędkości, η%-Sprawność maksymalna, N-Współczynnik sprawności, kW-Pobór mocy, m³/h-Wydajność, Pa-Ciśnienie, RPM-Prędkość obrotowa



CHARAKTERYSTYKI PRACY

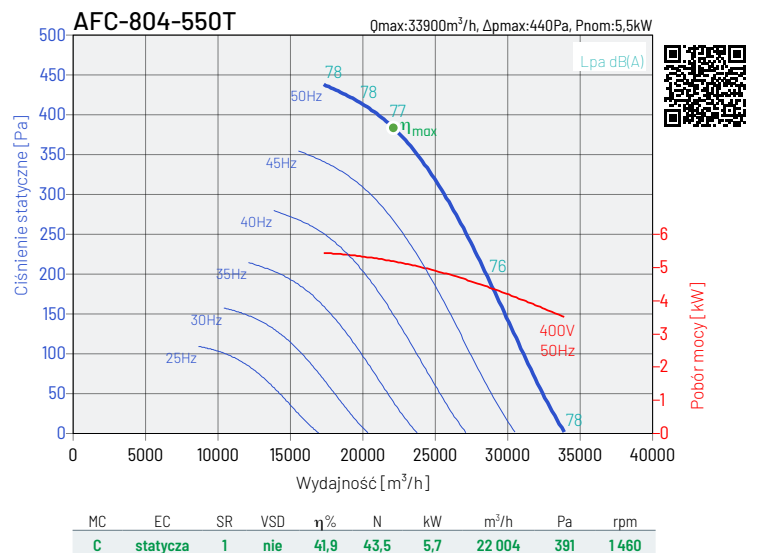
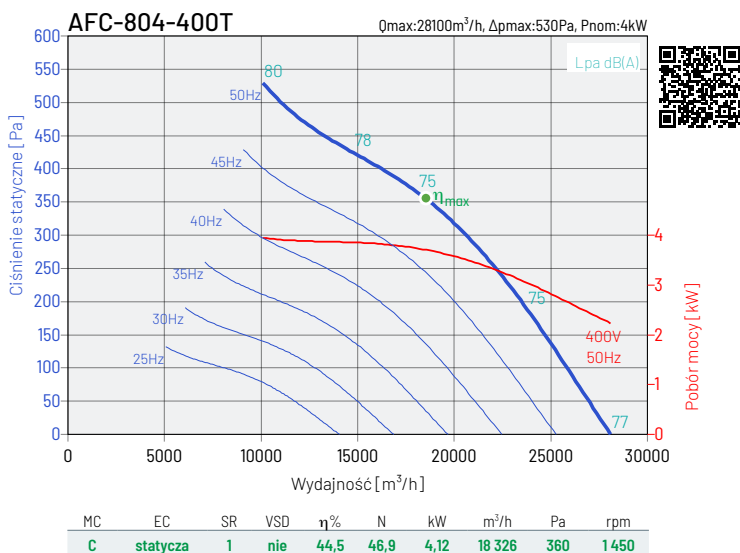
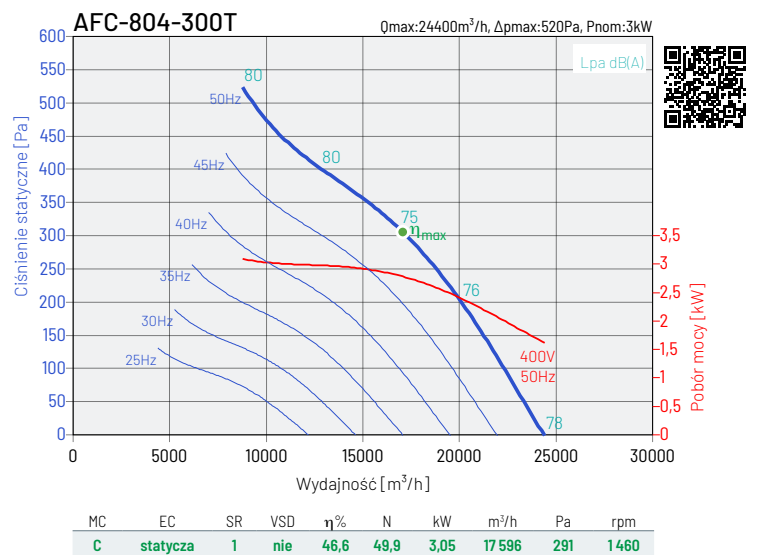
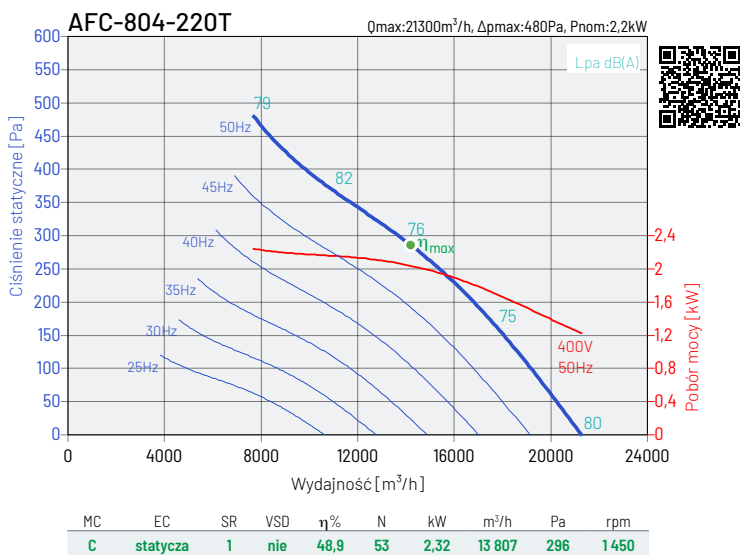
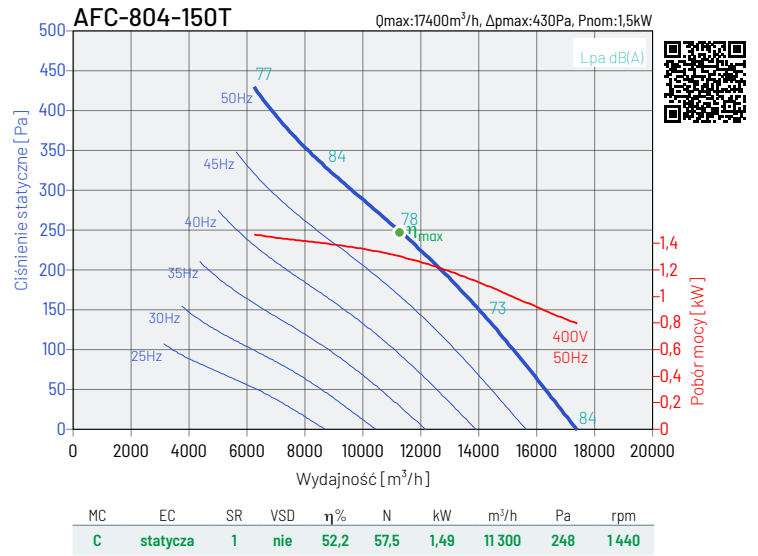
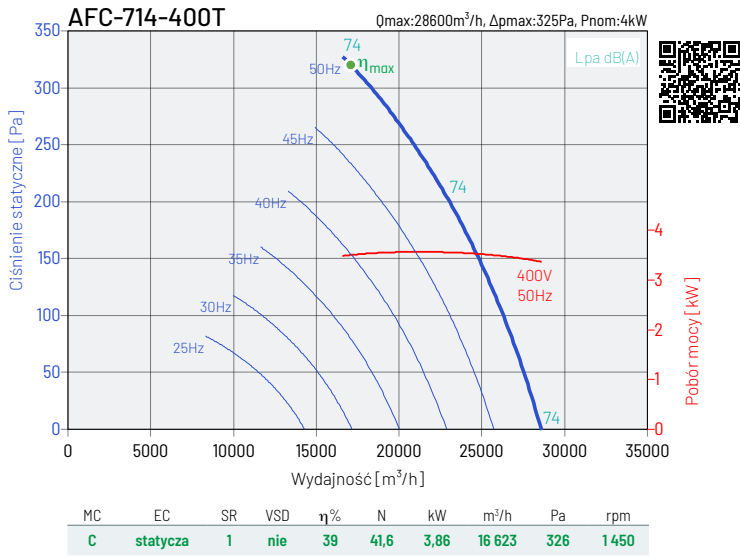

Charakterystyki pracy wentylatorów wyznaczone dla medium o temperaturze 20°C i ciśnieniu atmosferycznych 1013,25hPa. Poziom ciśnienia akustycznego dB(A), wyznaczany w odległości 1,5m

Dyrektywa ErP:

MC-Kategoria pomiarowa, EC-Kategoria sprawności, SR-Ilość biegów, VSD-Regulacja prędkości, η%-Sprawność maksymalna, N-Współczynnik sprawności, kW-Pobór mocy, m³/h-Wydajność, Pa-Ciśnienie, RPM-Prędkość obrotowa

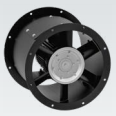

CHARAKTERYSTYKI PRACY

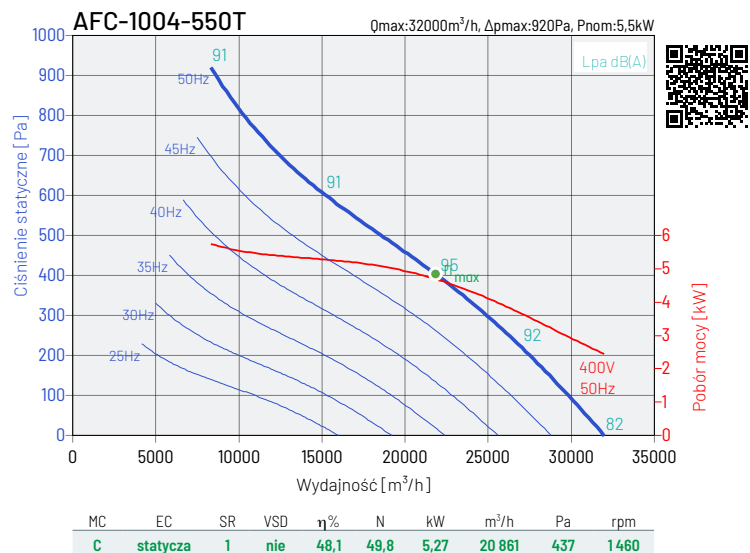
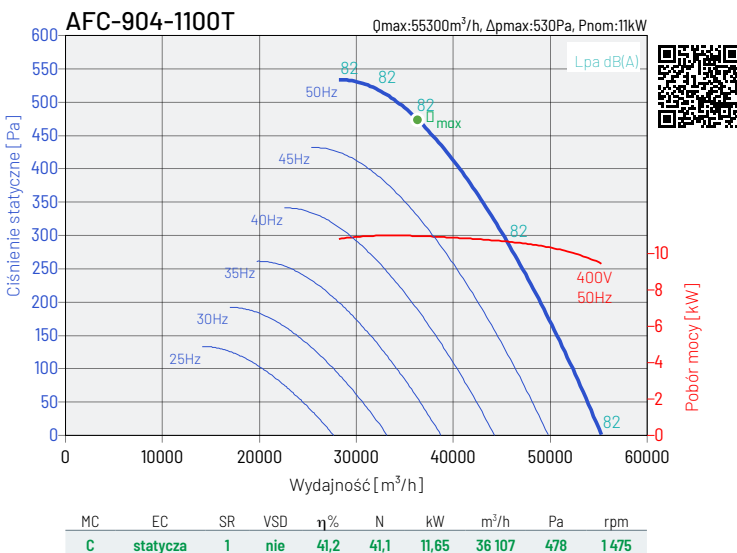
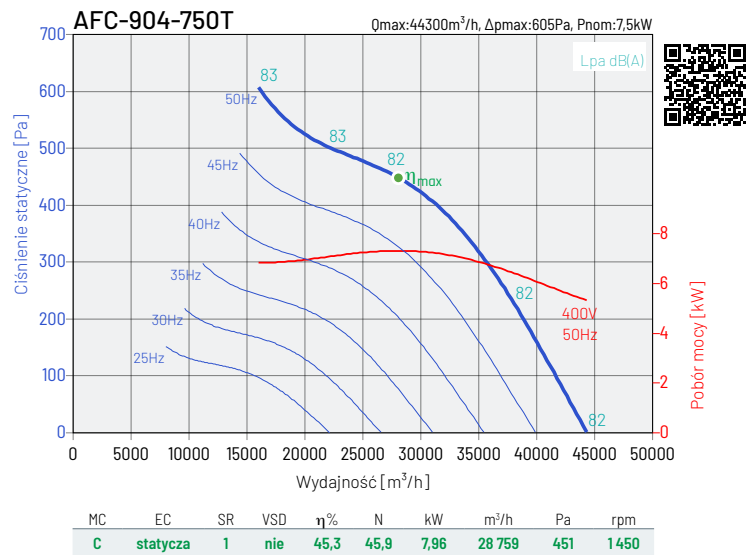
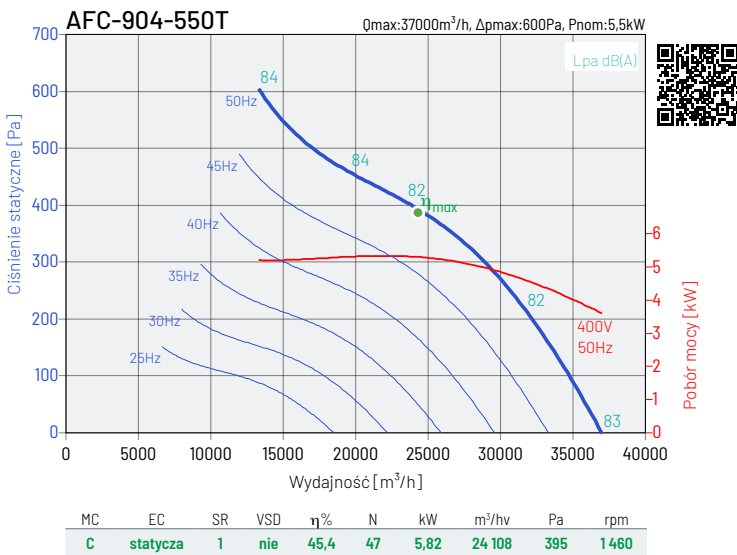
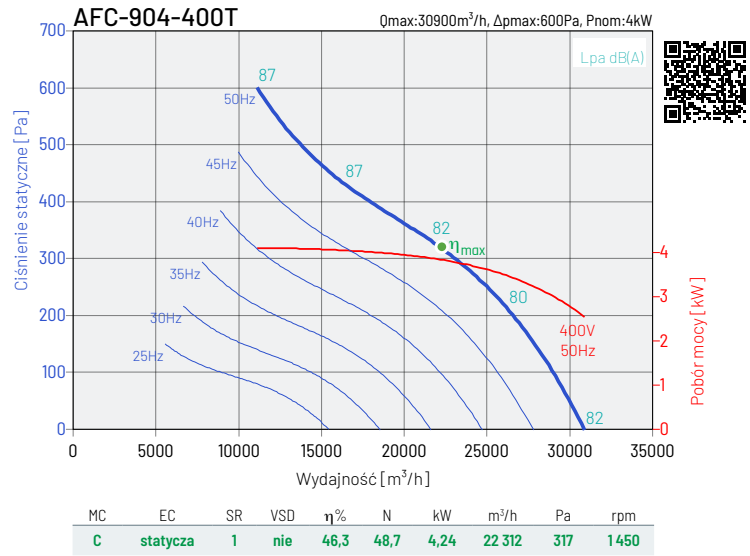

Charakterystyki pracy wentylatorów wyznaczone dla medium o temperaturze 20°C i ciśnieniu atmosferycznych 1013,25hPa. Poziom ciśnienia akustycznego dB(A), wyznaczany w odległości 1,5m

Dyrektywa ErP:

MC-Kategoria pomiarowa, EC-Kategoria sprawności, SR-Ilość biegów, VSD-Regulacja prędkości, η%-Sprawność maksymalna, N-Współczynnik sprawności, kW-Pobór mocy, m³/h-Wydajność, Pa-Ciśnienie, RPM-Prędkość obrotowa



CHARAKTERYSTYKI PRACY

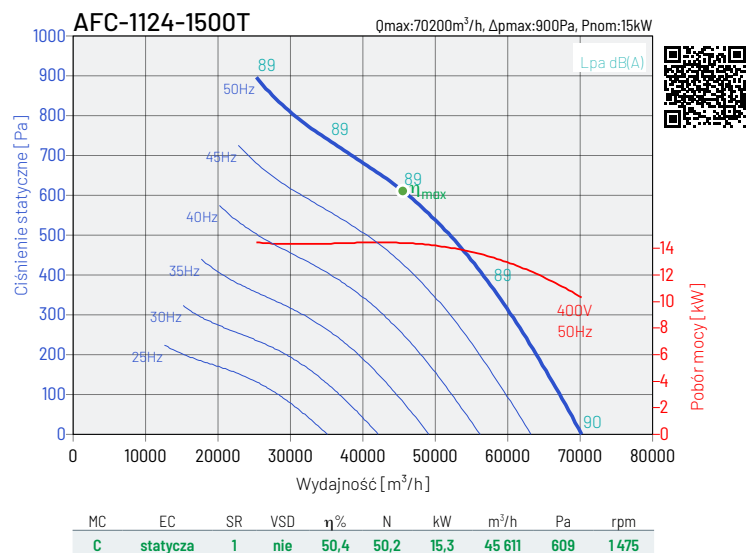
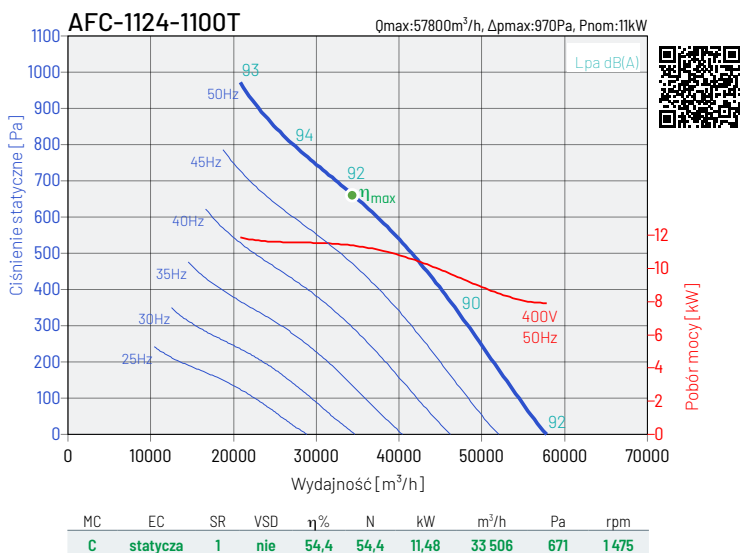
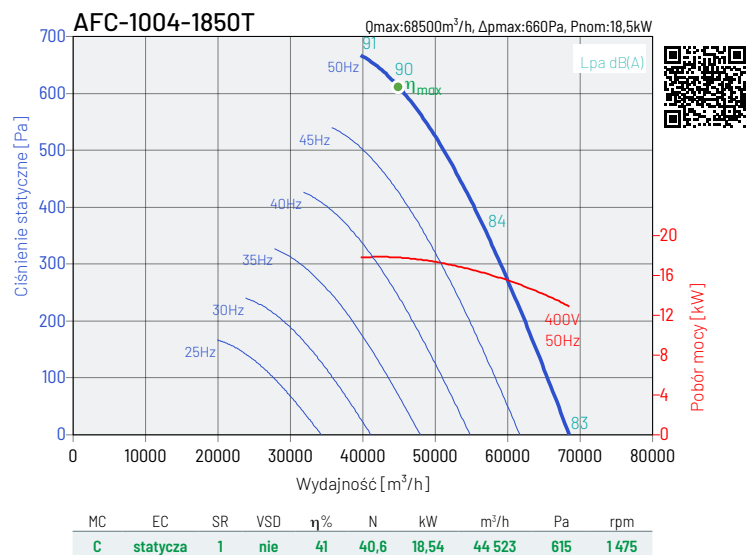
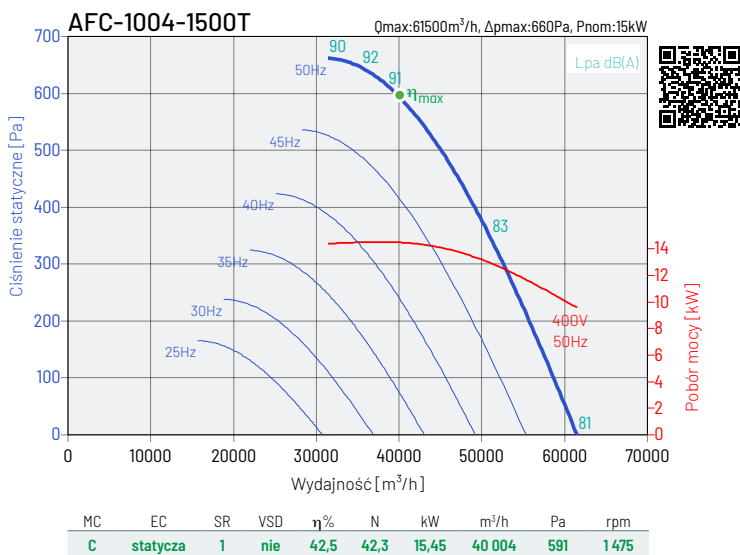
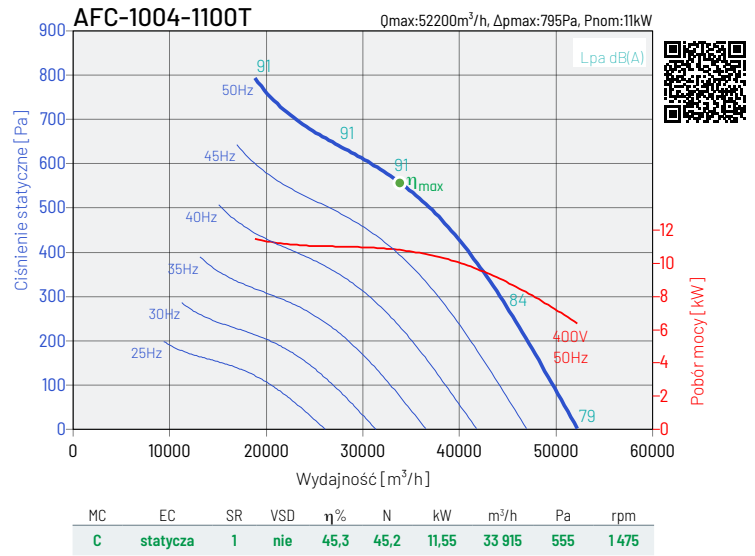
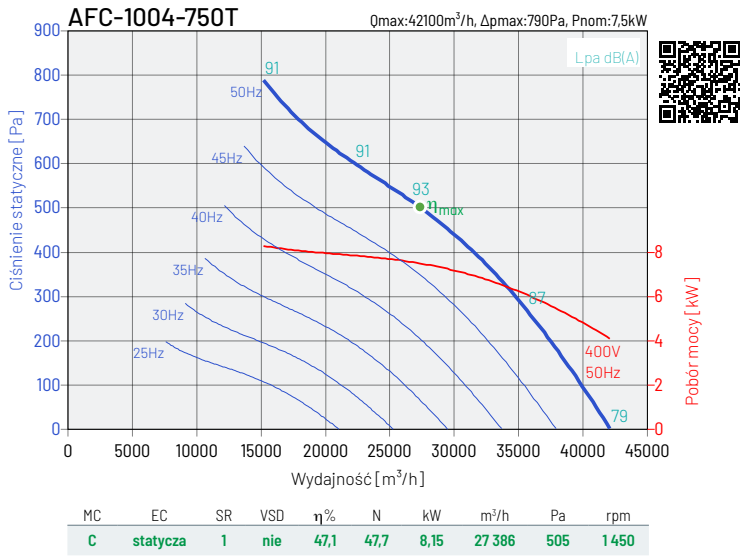

Charakterystyki pracy wentylatorów wyznaczone dla medium o temperaturze 20°C i ciśnieniu atmosferycznych 1013,25hPa. Poziom ciśnienia akustycznego dB(A), wyznaczany w odległości 1,5m

Dyrektywa ErP:

MC-Kategoria pomiarowa, EC-Kategoria sprawności, SR-Ilość biegów, VSD-Regulacja prędkości, $\eta\%$ -Sprawność maksymalna, N-Współczynnik sprawności, kW-Pobór mocy, m^3/h -Wydajność, Pa-Ciśnienie, RPM-Prędkość obrotowa



CHARAKTERYSTYKI PRACY

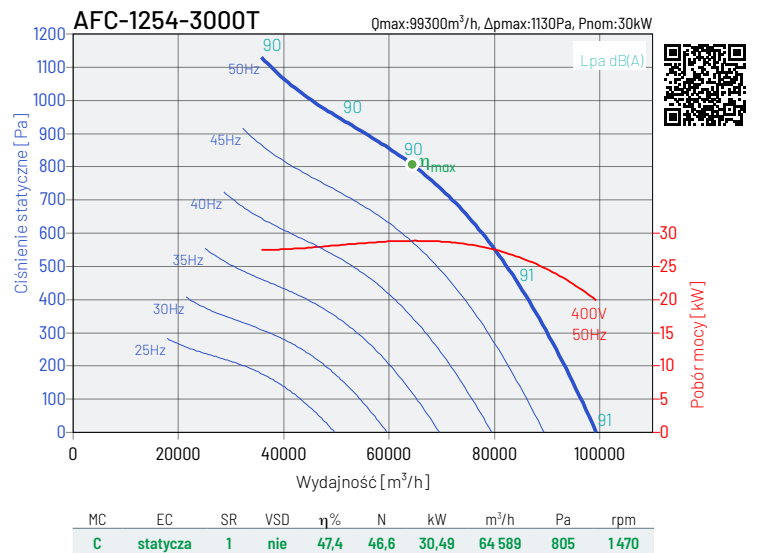
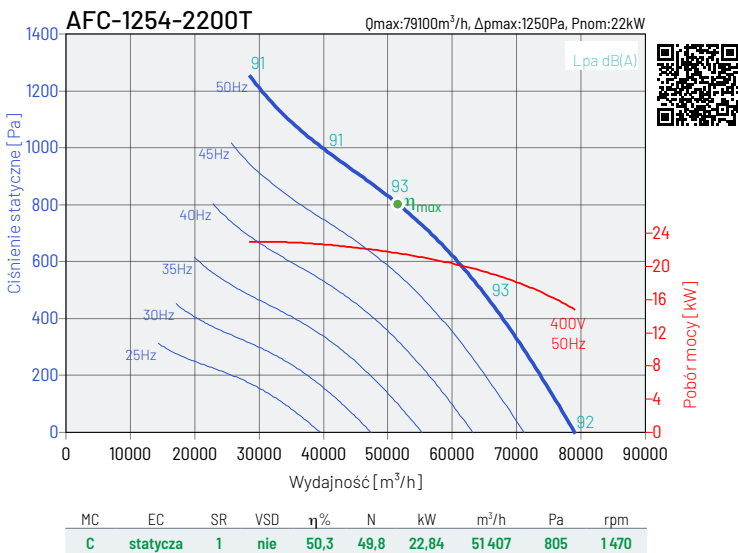
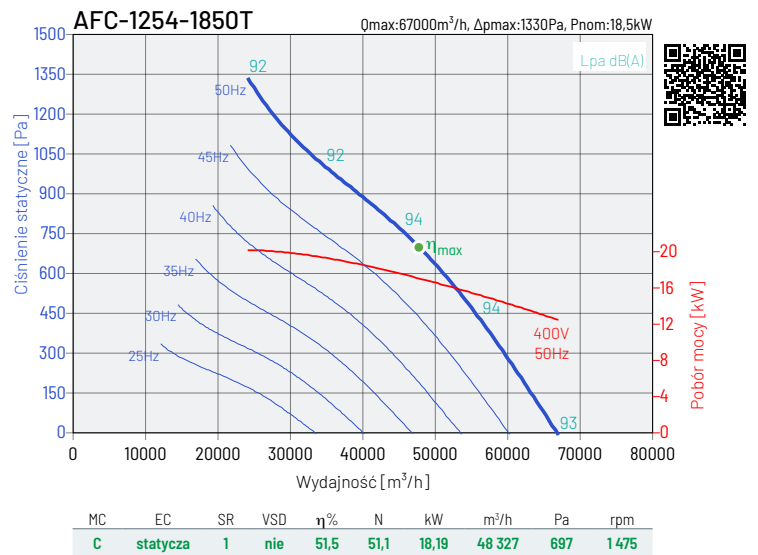
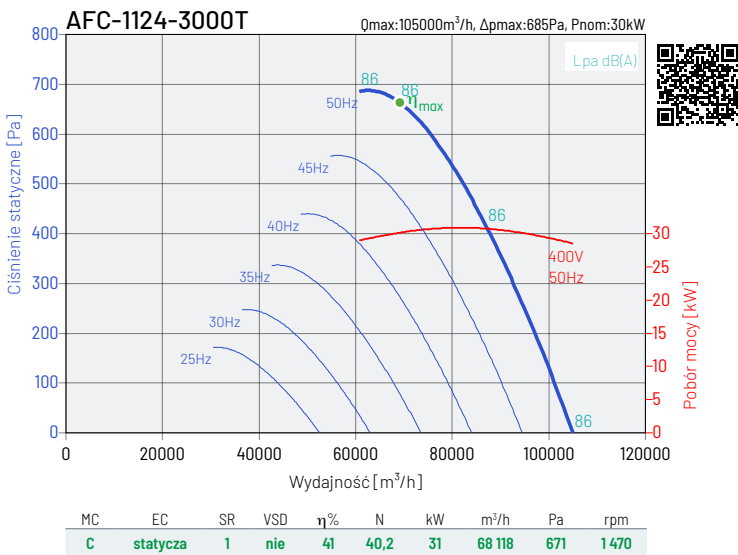
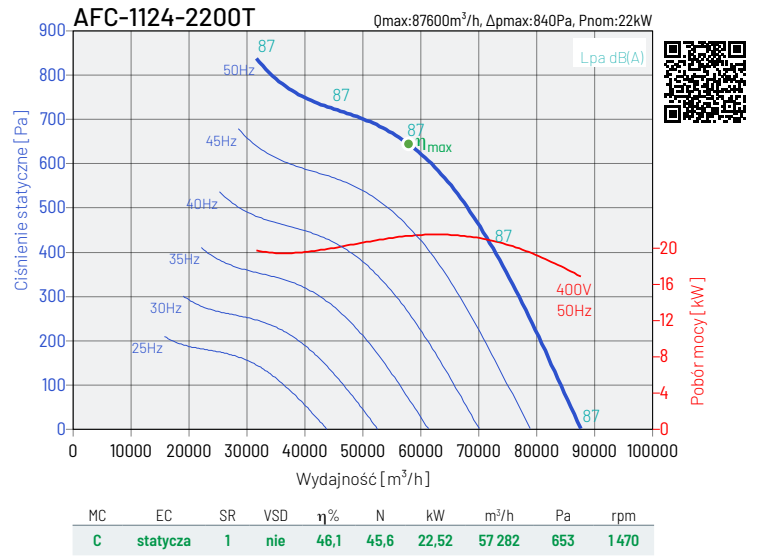
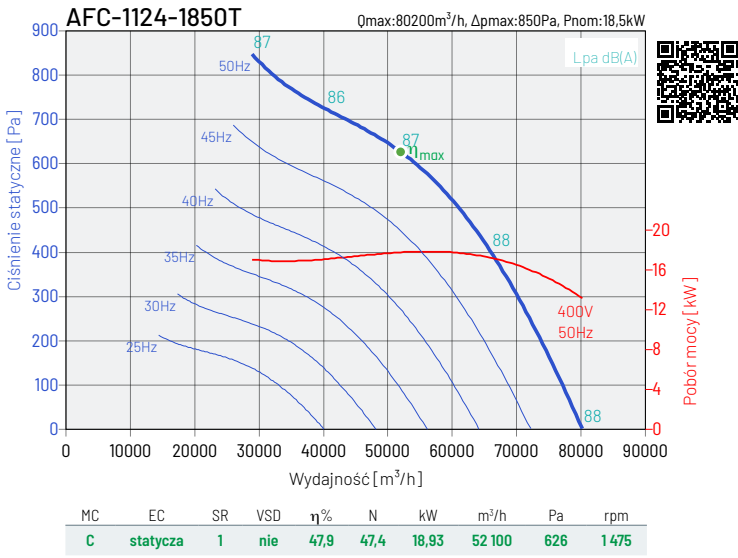

Charakterystyki pracy wentylatorów wyznaczone dla medium o temperaturze 20°C i ciśnieniu atmosferycznych 1013,25hPa. Poziom ciśnienia akustycznego dB(A), wyznaczany w odległości 1,5m

Dyrektywa ErP:

MC-Kategoria pomiarowa, EC-Kategoria sprawności, SR-Ilość biegów, VSD-Regulacja prędkości, $\eta\%$ -Sprawność maksymalna, N-Współczynnik sprawności, kW-Pobór mocy, m^3/h -Wydajność, Pa-Ciśnienie, RPM-Prędkość obrotowa



CHARAKTERYSTYKI PRACY

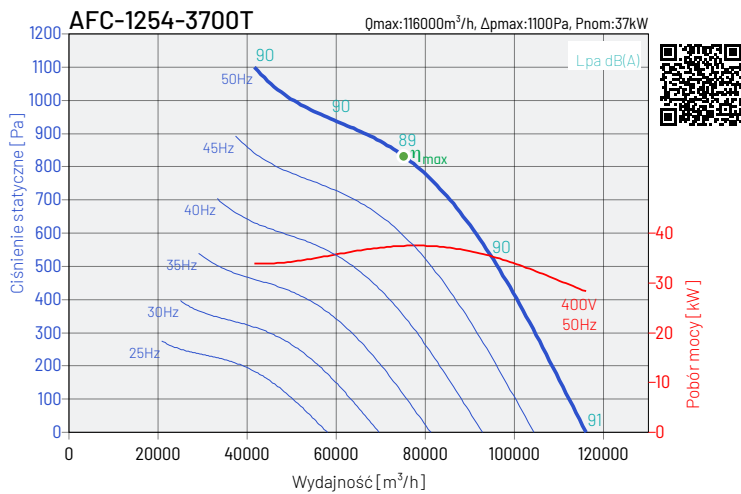

MC	EC	SR	VSD	η%	N	kW	m ³ /h	Pa	rpm
C	statyczna	1	nie	44,9	43,9	38,87	75 102	837	1485

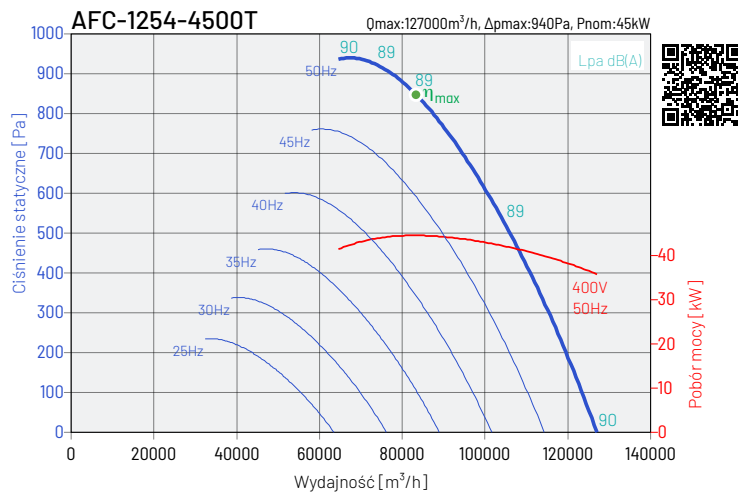

MC	EC	SR	VSD	η%	N	kW	m ³ /h	Pa	rpm
C	statyczna	1	nie	42,7	41,6	46,08	82 362	860	1485

Charakterystyki pracy wentylatorów wyznaczone dla medium o temperaturze 20°C i ciśnieniu atmosferycznych 1013,25hPa. Poziom ciśnienia akustycznego dB(A), wyznaczany w odległości 1,5m

Dyrektywa ErP:

MC-Kategoria pomiarowa, EC-Kategoria sprawności, SR-Ilość biegów, VSD-Regulacja prędkości, η%-Sprawność maksymalna, N-Współczynnik sprawności, kW-Pobór mocy, m³/h-Wydajność, Pa-Ciśnienie, RPM-Prędkość obrotowa



WYMIARY

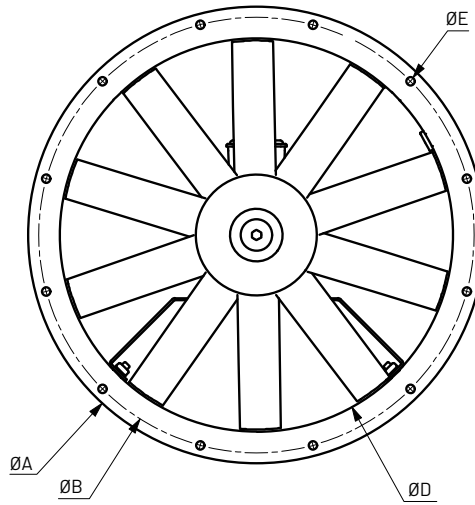
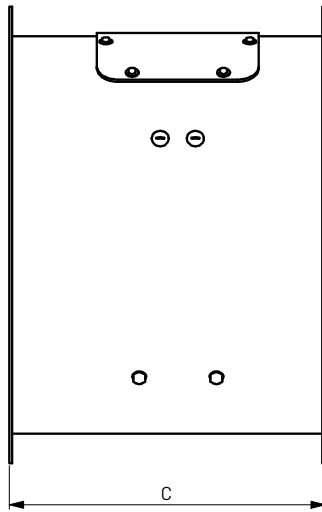

model wentylatora	ØA mm	ØB mm	ØC mm	ØD mm	ØE mm	N liczba otw.
AFC-402-075S	480	450	390	400	12	8
AFC-402-110S	480	450	390	400	12	8
AFC-402-075T	480	450	390	400	12	8
AFC-402-110T	480	450	390	400	12	8
AFC-402-150T	480	450	410	400	12	8
AFC-402-220T	480	450	410	400	12	8
AFC-402-300T	480	450	410	400	12	8
AFC-452-110S	530	500	430	450	12	8
AFC-452-110T	530	500	430	450	12	8
AFC-452-150T	530	500	430	450	12	8
AFC-452-220T	530	500	430	450	12	8
AFC-452-300T	530	500	430	450	12	8
AFC-452-400T	530	500	480	450	12	8
AFC-502-220T	590	560	450	500	12	12
AFC-502-300T	590	560	450	500	12	12
AFC-502-400T	590	560	520	500	12	12
AFC-502-550T	590	560	520	500	12	12
AFC-502-750T	590	560	520	500	12	12
AFC-562-300T	650	620	450	560	12	12
AFC-562-400T	650	620	580	560	12	12
AFC-562-550T	650	620	580	560	12	12
AFC-562-750T	650	620	580	560	12	12
AFC-562-1100T	650	620	580	560	12	12
AFC-564-037T	650	620	450	560	12	12
AFC-564-055T	650	620	450	560	12	12
AFC-564-075T	650	620	450	560	12	12
AFC-564-110T	650	620	450	560	12	12
AFC-564-150T	650	620	450	560	12	12
AFC-632-400T	720	690	540	630	12	12
AFC-632-550T	720	690	540	630	12	12
AFC-632-750T	720	690	540	630	12	12
AFC-632-1100T	720	690	630	630	12	12
AFC-632-1500T	720	690	740	630	12	12
AFC-634-055T	720	690	470	630	12	12

model wentylatora	ØA mm	ØB mm	ØC mm	ØD mm	ØE mm	N liczba otw.
AFC-634-075T	720	690	470	630	12	12
AFC-634-110T	720	690	470	630	12	12
AFC-634-150T	720	690	470	630	12	12
AFC-634-220T	720	690	540	630	12	12
AFC-714-110T	800	770	470	710	12	16
AFC-714-150T	800	770	470	710	12	16
AFC-714-220T	800	770	570	710	12	16
AFC-714-300T	800	770	570	710	12	16
AFC-714-400T	800	770	570	710	12	16
AFC-804-150T	890	860	500	800	12	16
AFC-804-220T	890	860	620	800	12	16
AFC-804-300T	890	860	620	800	12	16
AFC-804-400T	890	860	620	800	12	16
AFC-804-550T	890	860	620	800	12	16
AFC-904-300T	1005	970	600	900	15	16
AFC-904-400T	1005	970	600	900	15	16
AFC-904-550T	1005	970	750	900	15	16
AFC-904-750T	1005	970	750	900	15	16
AFC-904-1100T	1005	970	750	900	15	16
AFC-1004-550T	1105	1070	650	1000	15	16
AFC-1004-750T	1105	1070	650	1000	15	16
AFC-1004-1100T	1105	1070	810	1000	15	16
AFC-1004-1500T	1105	1070	810	1000	15	16
AFC-1004-1850T	1105	1070	810	1000	15	16
AFC-1124-1100T	1260	1190	810	1120	15	20
AFC-1124-1500T	1260	1190	810	1120	15	20
AFC-1124-1850T	1260	1190	810	1120	15	20
AFC-1124-2200T	1260	1190	810	1120	15	20
AFC-1124-3000T	1260	1190	1000	1120	15	20
AFC-1254-1850T	1390	1320	810	1250	15	20
AFC-1254-2200T	1390	1320	810	1250	15	20
AFC-1254-3000T	1390	1320	1100	1250	15	20
AFC-1254-3700T	1390	1320	1100	1250	15	20
AFC-1254-4500T	1390	1320	1100	1250	15	20



AKCESORIA MONTAŻOWE

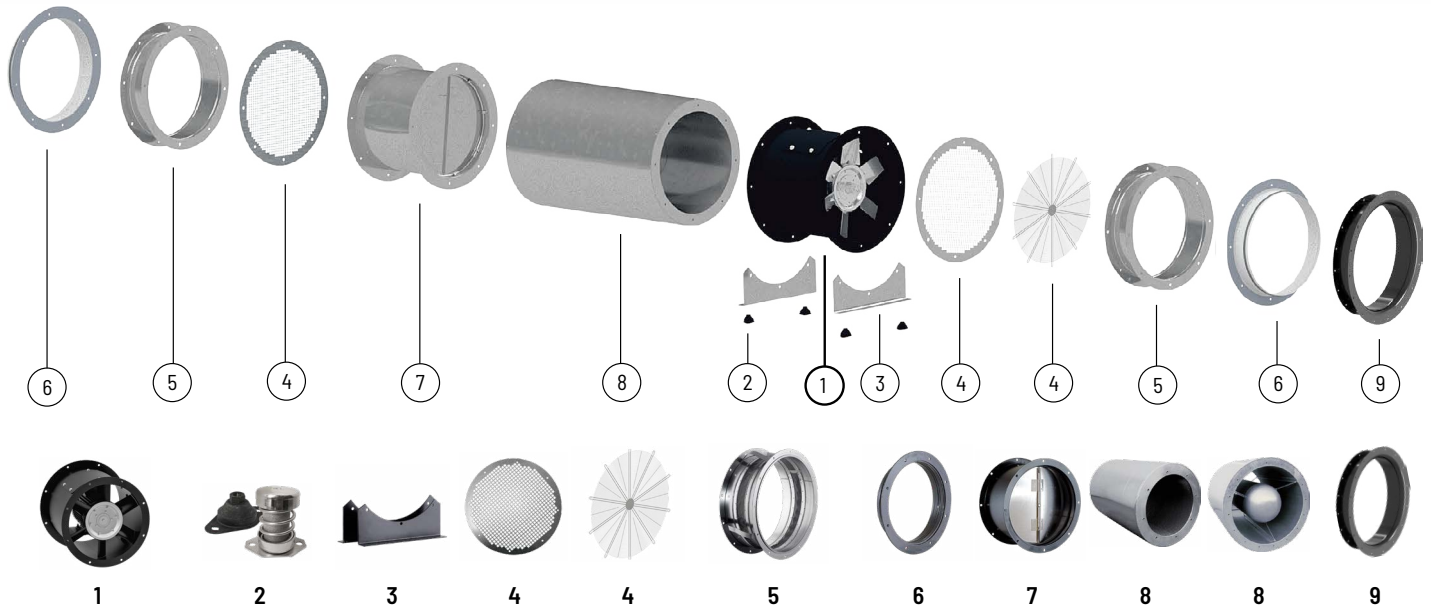

wentylator	wibroizolator	stopa montażowa	siatka ochronna	osłona wlotu	złącze przeciwdrganie	króciec	kłapa zwrotna	tłumik SIL-CZ	tłumik SIL-CZO	dysza wlotowa
AFC-402	AVM-20*	STOPA DN 400	SO Ø400	OW Ø400	ZŁĄCZE P-DRG Ø400	K Ø400	KZ Ø400	SIL-CZ 400	SIL-CZO 400	DW Ø400
AFC-452	AVM-20*	STOPA DN 450	SO Ø450	OW Ø450	ZŁĄCZE P-DRG Ø450	K Ø450	KZ Ø450	SIL-CZ 450	SIL-CZO 450	DW Ø450
AFC-502	AVM-35*	STOPA DN 500	SO Ø500	OW Ø500	ZŁĄCZE P-DRG Ø500	K Ø500	KZ Ø500	SIL-CZ 500	SIL-CZO 500	DW Ø500
AFC-56x	AVM-35*	STOPA DN 560	SO Ø560	OW Ø560	ZŁĄCZE P-DRG Ø560	K Ø560	KZ Ø560	SIL-CZ 560	SIL-CZO 560	DW Ø560
AFC-632	AM-50M*	STOPA DN 630	SO Ø630	OW Ø630	ZŁĄCZE P-DRG Ø630	K Ø630	KZ Ø630	SIL-CZ 630	SIL-CZO 630	DW Ø630
AFC-634	AVM-35*	STOPA DN 630	SO Ø630	OW Ø630	ZŁĄCZE P-DRG Ø630	K Ø630	KZ Ø630	SIL-CZ 630	SIL-CZO 630	DW Ø630
AFC-714	AVM-35*	STOPA DN 710	SO Ø710	OW Ø710	ZŁĄCZE P-DRG Ø710	K Ø710	KZ Ø710	SIL-CZ 710	SIL-CZO 710	DW Ø710
AFC-804	AVM-35**	STOPA DN 800	SO Ø800	OW Ø800	ZŁĄCZE P-DRG Ø800	K Ø800	KZ Ø800	SIL-CZ 800	SIL-CZO 800	DW Ø800
AFC-904-300T/750T	AVM-35**	STOPA DN 900	SO Ø900	OW Ø900	ZŁĄCZE P-DRG Ø900	K Ø900	KZ Ø900	SIL-CZ 900	SIL-CZO 900	DW Ø900
AFC-904-1100T	AM-50M**	STOPA DN 900	SO Ø900	OW Ø900	ZŁĄCZE P-DRG Ø900	K Ø900	KZ Ø900	SIL-CZ 900	SIL-CZO 900	DW Ø900
AFC-1004-550T/750T	AVM-35**	STOPA DN 1000	SO Ø1000	OW Ø1000	ZŁĄCZE P-DRG Ø1000	K Ø1000	KZ Ø1000	SIL-CZ 1000	SIL-CZO 1000	DW Ø1000
AFC-1004-1100T/1850T	AM-50M**	STOPA DN 1000	SO Ø1000	OW Ø1000	ZŁĄCZE P-DRG Ø1000	K Ø1000	KZ Ø1000	SIL-CZ 1000	SIL-CZO 1000	DW Ø1000
AFC-1124-1100T/2200T	AM-75M**	STOPA DN 1120	SO Ø1120	OW Ø1120	ZŁĄCZE P-DRG Ø1120	K Ø1120	KZ Ø1120	SIL-CZ 1120	SIL-CZO 1120	DW Ø1120
AFC-1124-3000T	AM-100M**	STOPA DN 1120	SO Ø1120	OW Ø1120	ZŁĄCZE P-DRG Ø1120	K Ø1120	KZ Ø1120	SIL-CZ 1120	SIL-CZO 1120	DW Ø1120
AFC-1254-1850T/2200T	AM-100M**	STOPA DN 1250	SO Ø1250	OW Ø1250	ZŁĄCZE P-DRG Ø1250	K Ø1250	KZ Ø1250	SIL-CZ 1250	SIL-CZO 1250	DW Ø1250
AFC-1254-3000T	AM-125M**	STOPA DN 1250	SO Ø1250	OW Ø1250	ZŁĄCZE P-DRG Ø1250	K Ø1250	KZ Ø1250	SIL-CZ 1250	SIL-CZO 1250	DW Ø1250
AFC-1254-3700T/4500T	AM-150M**	STOPA DN 1250	SO Ø1250	OW Ø1250	ZŁĄCZE P-DRG Ø1250	K Ø1250	KZ Ø1250	SIL-CZ 1250	SIL-CZO 1250	DW Ø1250

Numerы artykułów

* 4szt. na wentylator ** 6 szt. na wentylator

26040960	AVM-20	42518130	OW Ø400	42517203	K Ø900	42519020-41	SIL-CZ 560-840	42519020-11	SIL-CZO 560-840
26040965	AVM-35	42518143	OW Ø450	42517213	K Ø1000	42519020-44	SIL-CZ 630-945	42519020-14	SIL-CZO 630-945
41021391	AM-50M	42518150	OW Ø500	42517223	K Ø1120	42519020-47	SIL-CZ 710-1065	42519020-17	SIL-CZO 710-1065
41021392	AM-75M	42518160	OW Ø560	42517233	K Ø1250	42519020-50	SIL-CZ 800-1200	42519020-20	SIL-CZO 800-1200
41021393	AM-100M	42518170	OW Ø630	42516513	KZ Ø400	42519020-53	SIL-CZ 900-1350	42519020-23	SIL-CZO 900-1350
41021394	AM-125M	42518183	OW Ø710	42516517	KZ Ø450	42519020-56	SIL-CZ 1000-1500	42519020-26	SIL-CZO 1000-1500
41021395	AM-150M	42518193	OW Ø800	42516520	KZ Ø500	42519020-33	SIL-CZ 400-800	42519020-03	SIL-CZO 400-800
42516133	STOPA DN 400	42518203	OW Ø900	42516524	KZ Ø560	42519020-36	SIL-CZ 450-900	42519020-06	SIL-CZO 450-900
42516143	STOPA DN 450	42518213	OW Ø1000	42516528	KZ Ø630	42519020-39	SIL-CZ 500-1000	42519020-09	SIL-CZO 500-1000
42516153	STOPA DN 500	42518253	OW Ø1120	42516537	KZ Ø710	42519020-42	SIL-CZ 560-1120	42519020-12	SIL-CZO 560-1120
42516163	STOPA DN 560	42518263	OW Ø1250	42516545	KZ Ø800	42519020-45	SIL-CZ 630-1260	42519020-15	SIL-CZO 630-1260
42516173	STOPA DN 630	42519530	ZŁĄCZE P-DRG Ø400	42516549	KZ Ø900	42519020-48	SIL-CZ 710-1420	42519020-18	SIL-CZO 710-1420
42516183	STOPA DN 710	42519543	ZŁĄCZE P-DRG Ø450	42516557	KZ Ø1000	42519020-51	SIL-CZ 800-1600	42519020-21	SIL-CZO 800-1600
42516193	STOPA DN 800	42519550	ZŁĄCZE P-DRG Ø500	42516563	KZ Ø1120	42519020-54	SIL-CZ 900-1800	42519020-24	SIL-CZO 900-1800
42516203	STOPA DN 900	42519560	ZŁĄCZE P-DRG Ø560	42516567	KZ Ø1250	42519020-57	SIL-CZ 1000-2000	42519404/42519454	DW Ø400
42516213	STOPA DN 1000	42519570	ZŁĄCZE P-DRG Ø630	42519020-31	SIL-CZ 400-400	42519020-01	SIL-CZO 400-400	42519406/42519456	DW Ø450
42516253	STOPA DN 1120	42519583	ZŁĄCZE P-DRG Ø710	42519020-34	SIL-CZ 450-450	42519020-04	SIL-CZO 450-450	42519408/42519458	DW Ø500
42516263	STOPA DN 1250	42519593	ZŁĄCZE P-DRG Ø800	42519020-37	SIL-CZ 500-500	42519020-07	SIL-CZO 500-500	42519410/42519460	DW Ø560
40522314	SO Ø400	42519603	ZŁĄCZE P-DRG Ø900	42519020-40	SIL-CZ 560-560	42519020-10	SIL-CZO 560-560	42519412/42519462	DW Ø630
40522314-01	SO Ø450	42519613	ZŁĄCZE P-DRG Ø1000	42519020-43	SIL-CZ 630-630	42519020-13	SIL-CZO 630-630	42519414/42519464	DW Ø710
40522314-02	SO Ø500	42519623	ZŁĄCZE P-DRG Ø1120	42519020-46	SIL-CZ 710-710	42519020-16	SIL-CZO 710-710	42519416/42519466	DW Ø800
40522314-03	SO Ø560	42519633	ZŁĄCZE P-DRG Ø1250	42519020-49	SIL-CZ 800-800	42519020-19	SIL-CZO 800-800	42519418/42519468	DW Ø900
40522314-04	SO Ø630	42517130	K Ø400	42519020-52	SIL-CZ 900-900	42519020-22	SIL-CZO 900-900	42519420/42519470	DW Ø1000
40522314-05	SO Ø710	42517143	K Ø450	42519020-55	SIL-CZ 1000-1000	42519020-25	SIL-CZO 1000-1000	42519422/42519472	DW Ø1120
40522314-06	SO Ø800	42517150	K Ø500	42519000-62	SIL-CZ 1120-1120	42519000-65	SIL-CZO 1120-1120	42519424/42519474	DW Ø1250
40522314-07	SO Ø900	42517160	K Ø560	42519000-58	SIL-CZ 1250-1250	42519000-28	SIL-CZO 1250-1250		
40522314-08	SO Ø1000	42517170	K Ø630	42519020-32	SIL-CZ 400-600	42519020-02	SIL-CZO 400-600		
40522314-10	SO Ø1120	42517183	K Ø710	42519020-35	SIL-CZ 450-675	42519020-05	SIL-CZO 450-675		
40522314-09	SO Ø1250	42517193	K Ø800	42519020-38	SIL-CZ 500-750	42519020-08	SIL-CZO 500-750		



AKCESORIA ELEKTRYCZNE - Silniki jednofazowe



wentylator	termostat ścienny	termostat kanałowy	czujnik zanieczyszczenia	higrostat	regulator tyrystorowy	regulator transformatorowy		regulator transformatorowy 2-nastawowy	
	TS	TK-21	SQA	HIG-2	REB	RMB	RVS	SC2	SC2A
AFC-402-075S	TS	TK-21	SQA	HIG-2	REB-10	RMB-8	RVS-7	SC2-1-75L25	SC2A1-75L25
AFC-402-110S	TS	TK-21	SQA	HIG-2	REB-10	RMB-8	RVS-7	SC2-1-110L25	SC2A1-110L25
AFC-452-110S	TS	TK-21	SQA	HIG-2	REB-10	RMB-8	RVS-7	SC2-1-110L25	SC2A1-110L25

AKCESORIA ELEKTRYCZNE - Silniki trójfazowe



wentylator	termostat ścienny	termostat kanałowy	czujnik zanieczyszczenia	higrostat	falownik
	TS	TK-21	SQA	HIG-2	L
AFC-402-075T	TS + DILM7	TK-21+ DILM7	SQA + DILM7	HIG-2 + DILM7	L 0.75kW
AFC-402-110T	TS + DILM7	TK-21 + DILM7	SQA + DILM7	HIG-2 + DILM7	L 1.5kW
AFC-402-150T	TS + DILM7	TK-21 + DILM7	SQA + DILM7	HIG-2 + DILM7	L 1.5kW
AFC-402-220T	TS + DILM7	TK-21 + DILM7	SQA + DILM7	HIG-2 + DILM7	L 2.2kW
AFC-402-300T	TS + DILM7	TK-21 + DILM7	SQA + DILM7	HIG-2 + DILM7	L 4.0kW
AFC-452-110T	TS + DILM7	TK-21 + DILM7	SQA + DILM7	HIG-2 + DILM7	L 1.5kW
AFC-452-150T	TS + DILM7	TK-21 + DILM7	SQA + DILM7	HIG-2 + DILM7	L 1.5kW
AFC-452-220T	TS + DILM7	TK-21 + DILM7	SQA + DILM7	HIG-2 + DILM7	L 2.2kW
AFC-452-300T	TS + DILM7	TK-21 + DILM7	SQA + DILM7	HIG-2 + DILM7	L 4.0kW
AFC-452-400T	TS + DILM9	TK-21 + DILM9	SQA + DILM9	HIG-2 + DILM9	L 4.0kW
AFC-502-220T	TS + DILM7	TK-21 + DILM7	SQA + DILM7	HIG-2 + DILM7	L 2.2kW
AFC-502-300T	TS + DILM7	TK-21 + DILM7	SQA + DILM7	HIG-2 + DILM7	L 4.0kW
AFC-502-400T	TS + DILM9	TK-21 + DILM9	SQA + DILM9	HIG-2 + DILM9	L 4.0kW
AFC-502-550T	TS + DILM12	TK-21 + DILM12	SQA + DILM12	HIG-2 + DILM12	L 5.5kW
AFC-502-750T	TS + DILM15	TK-21 + DILM15	SQA + DILM15	HIG-2 + DILM15	L 7.5kW
AFC-562-300T	TS + DILM7	TK-21 + DILM7	SQA + DILM7	HIG-2 + DILM7	L 4.0kW
AFC-562-400T	TS + DILM9	TK-21 + DILM9	SQA + DILM9	HIG-2 + DILM9	L 4.0kW
AFC-562-550T	TS + DILM12	TK-21 + DILM12	SQA + DILM12	HIG-2 + DILM12	L 5.5kW
AFC-562-750T	TS + DILM15	TK-21 + DILM15	SQA + DILM15	HIG-2 + DILM15	L 7.5kW
AFC-562-1100T	TS + DILM25	TK-21 + DILM25	SQA + DILM25	HIG-2 + DILM25	L 11.0kW
AFC-564-037T	TS + DILM7	TK-21 + DILM7	SQA + DILM7	HIG-2 + DILM7	L 0.4kW
AFC-564-055T	TS + DILM7	TK-21 + DILM7	SQA + DILM7	HIG-2 + DILM7	L 0.75kW
AFC-564-075T	TS + DILM7	TK-21 + DILM7	SQA + DILM7	HIG-2 + DILM7	L 0.75kW
AFC-564-110T	TS + DILM7	TK-21 + DILM7	SQA + DILM7	HIG-2 + DILM7	L 1.5kW
AFC-564-150T	TS + DILM7	TK-21 + DILM7	SQA + DILM7	HIG-2 + DILM7	L 1.5kW
AFC-632-400T	TS + DILM9	TK-21 + DILM9	SQA + DILM9	HIG-2 + DILM9	L 4.0kW
AFC-632-550T	TS + DILM12	TK-21 + DILM12	SQA + DILM12	HIG-2 + DILM12	L 5.5kW
AFC-632-750T	TS + DILM15	TK-21 + DILM15	SQA + DILM15	HIG-2 + DILM15	L 7.5kW
AFC-632-1100T	TS + DILM25	TK-21 + DILM25	SQA + DILM25	HIG-2 + DILM25	L 11.0kW
AFC-632-1500T	TS + DILM32	TK-21 + DILM32	SQA + DILM32	HIG-2 + DILM32	L 0.4kW



AKCESORIA ELEKTRYCZNE - Silniki trójfazowe



wentylator	termostat ścienny	termostat kanałowy	czujnik zanieczyszczenia	higrostat	falownik
	TS	TK-21	SQA	HIG-2	L
AFC-634-055T	TS + DILM7	TK-21 + DILM7	SQA + DILM7	HIG-2 + DILM7	L 0.75kW
AFC-634-075T	TS + DILM7	TK-21 + DILM7	SQA + DILM7	HIG-2 + DILM7	L 0.75kW
AFC-634-110T	TS + DILM7	TK-21 + DILM7	SQA + DILM7	HIG-2 + DILM7	L 1.5kW
AFC-634-150T	TS + DILM7	TK-21 + DILM7	SQA + DILM7	HIG-2 + DILM7	L 1.5kW
AFC-634-220T	TS + DILM7	TK-21 + DILM7	SQA + DILM7	HIG-2 + DILM7	L 2.2kW
AFC-714-110T	TS + DILM7	TK-21 + DILM7	SQA + DILM7	HIG-2 + DILM7	L 1.5kW
AFC-714-150T	TS + DILM7	TK-21 + DILM7	SQA + DILM7	HIG-2 + DILM7	L 1.5kW
AFC-714-220T	TS + DILM7	TK-21 + DILM7	SQA + DILM7	HIG-2 + DILM7	L 2.2kW
AFC-714-300T	TS + DILM7	TK-21 + DILM7	SQA + DILM7	HIG-2 + DILM7	L 4.0kW
AFC-714-400T	TS + DILM9	TK-21 + DILM9	SQA + DILM9	HIG-2 + DILM9	L 4.0kW
AFC-804-150T	TS + DILM7	TK-21 + DILM7	SQA + DILM7	HIG-2 + DILM7	L 1.5kW
AFC-804-220T	TS + DILM7	TK-21 + DILM7	SQA + DILM7	HIG-2 + DILM7	L 2.2kW
AFC-804-300T	TS + DILM7	TK-21 + DILM7	SQA + DILM7	HIG-2 + DILM7	L 4.0kW
AFC-804-400T	TS + DILM9	TK-21 + DILM9	SQA + DILM9	HIG-2 + DILM9	L 4.0kW
AFC-804-550T	TS + DILM12	TK-21 + DILM12	SQA + DILM12	HIG-2 + DILM12	L 5.5kW
AFC-904-300T	TS + DILM7	TK-21 + DILM7	SQA + DILM7	HIG-2 + DILM7	L 4.0kW
AFC-904-400T	TS + DILM9	TK-21 + DILM9	SQA + DILM9	HIG-2 + DILM9	L 4.0kW
AFC-904-550T	TS + DILM12	TK-21 + DILM12	SQA + DILM12	HIG-2 + DILM12	L 5.5kW
AFC-904-750T	TS + DILM15	TK-21 + DILM15	SQA + DILM15	HIG-2 + DILM15	L 7.5kW
AFC-904-1100T	TS + DILM25	TK-21 + DILM25	SQA + DILM25	HIG-2 + DILM25	L 11.0kW
AFC-1004-550T	TS + DILM12	TK-21 + DILM12	SQA + DILM12	HIG-2 + DILM12	L 5.5kW
AFC-1004-750T	TS + DILM15	TK-21 + DILM15	SQA + DILM15	HIG-2 + DILM15	L 7.5kW
AFC-1004-1100T	TS + DILM25	TK-21 + DILM25	SQA + DILM25	HIG-2 + DILM25	L 11.0kW
AFC-1004-1500T	TS + DILM32	TK-21 + DILM32	SQA + DILM32	HIG-2 + DILM32	L 15.0kW
AFC-1004-1850T	TS + DILM40	TK-21 + DILM40	SQA + DILM40	HIG-2 + DILM40	L 18.5kW
AFC-1124-1100T	TS + DILM25	TK-21 + DILM25	SQA + DILM25	HIG-2 + DILM25	L 11.0kW
AFC-1124-1500T	TS + DILM32	TK-21 + DILM32	SQA + DILM32	HIG-2 + DILM32	L 15.0kW
AFC-1124-1850T	TS + DILM40	TK-21 + DILM40	SQA + DILM40	HIG-2 + DILM40	L 18.5kW
AFC-1124-2200T	TS + DILM50	TK-21 + DILM50	SQA + DILM50	HIG-2 + DILM50	L 22.0kW
AFC-1124-3000T	TS + DILM65	TK-21 + DILM65	SQA + DILM65	HIG-2 + DILM65	L 30.0kW
AFC-1254-1850T	TS + DILM40	TK-21 + DILM40	SQA + DILM40	HIG-2 + DILM40	L 18.5kW
AFC-1254-2200T	TS + DILM50	TK-21 + DILM50	SQA + DILM50	HIG-2 + DILM50	L 22.0kW
AFC-1254-3000T	TS + DILM65	TK-21 + DILM65	SQA + DILM65	HIG-2 + DILM65	L 30.0kW
AFC-1254-3700T	TS + DILM80	TK-21 + DILM80	SQA + DILM80	HIG-2 + DILM80	L 37.0kW
AFC-1254-4500T	TS + DILM95	TK-21 + DILM95	SQA + DILM95	HIG-2 + DILM95	L 45.0kW

Numery artykułów

40025345 TS
40025320 TK-21
40025140 SQA
40025150 HIG-2

40025055 REB-10
40025080 RMB-8
40025236 RVS-7

40025258 SC2-1-75L25
40025260 SC2-1-110L25
40025259 SC2A1-75L25
40025261 SC2A1-110L25

40016302 L 0.4kW
40016312 L 0.75kW
40016322 L 1.5kW
40016332 L 2.2kW
40016352 L 4.0kW
40016362 L 5.5kW
40016372 L 7.5kW
40016383 L 11.0kW
40016392 L 15.0kW
40016412 L 18.5kW
40016422 L 22.0kW
* L 30.0kW
* L 37.0kW
* L 45.0kW

91040997 DILM7
91040666-40 DILM9
91040666-41 DILM12
91040666-42 DILM15
91040905 DILM25
91040666-44 DILM32
91040666-45 DILM40
91040666-46 DILM50
* DILM65
* DILM80
* DILM95
* na zapytanie