

### Anwendung

Abluft-Dachventilatoren REX-H erfüllen die Anforderungen der Richtlinie ATEX 2014/34EU, sind für den Einsatz konzipiert in explosionsgefährdeten Bereichen außerhalb von Bergwerken und Bergbauausgrabungen, erfüllen die Anforderungen der Gruppe II, Kategorie 2G/3G – Zone 1 oder 2 und der Kategorie 2D/3D – Zone 21 und/oder 22.

### ATEX-Kennzeichnung:

II 2G Ex h IIB+H2 T3 Gb  
II 2G Ex h IIB+H2 T4 Gb  
II 2D Ex h IIIC T125°C Db

### Konstruktion

- Mitteldruck-Radialventilator mit Direktantrieb,
- Laufrad aus Aluminiumblech mit nach hinten geneigten Schaufeln, dynamisch ausgewuchtet nach ISO 1940-1,
- Gehäuseelemente aus Rohaluminium und Edelstahl,
- maximaler Temperaturbereich des Fördermediums von -20°C bis +60°C,
- Mindestumgebungstemperatur -20°C,
- Geeignet für die Montage eines Vibrationssensors.

### Elektrischer Motor

- explosionsgeschützt, asynchron, einphasig 230V 50Hz,
- explosionsgeschützt, asynchron, dreiphasig 230/400V 50Hz oder 400/690V 50Hz (abhängig von der Motorleistung),
- Isolationsklasse F,
- PTC-Wärmeschutz,
- VFD-Version angepasst an die Frequenzregelung.

### Sonderausführung

- lackiertes Gehäuse,
- Motor für andere als die Standardspannung und Netzfrequenz,
- Motor mit unterschiedlichem IP-Schutzgrad,
- Laufrad und Gehäuse aus Edelstahl,
- Umgebungstemperatur bis +60°C.

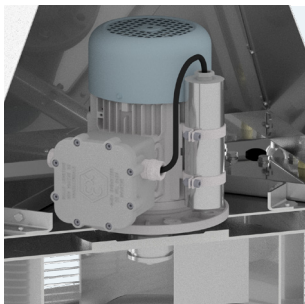
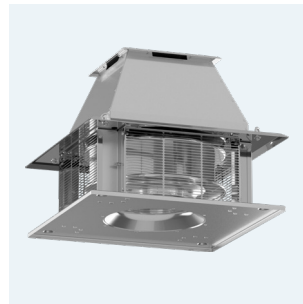
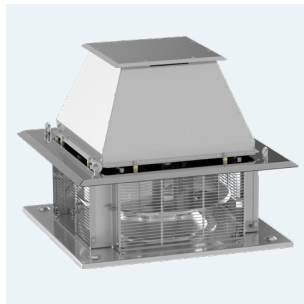
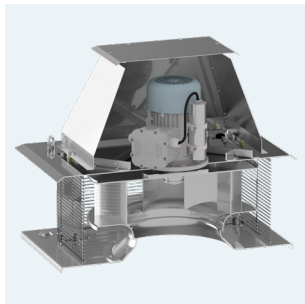

### VERWANDTE PRODUKTE



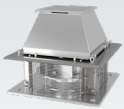

## NENNDATEN

Typ	Volumenstrom max	Druck max	Motor Drehzahl	Nennspannung	Nennstrom**	Motorleistung	Schalldruckpegel Fall*	Temp.-betrieb min / max	Temp.-umgebungs min / max	Gewicht	Artikelnummer
<b>2-POLIGE MOTOREN 3000RPM</b>											
REX-H/2-190-012T 2G	750 m³/h	350 Pa	2 750 rpm	400 V	0,4 A	120 W	68 dB(A)	-20 / 60 °C	-20 / 40 °C	12,0 kg	45527200
REX-H/2-190-012T 2G VFD	750 m³/h	350 Pa	2 800 rpm	400 V	0,48 A	120 W	68 dB(A)	-20 / 60 °C	-20 / 50 °C	14,0 kg	425527201
REX-H/2-190-012T 2GD VFD	750 m³/h	350 Pa	2 800 rpm	400 V	0,48 A	120 W	68 dB(A)	-20 / 60 °C	-20 / 50 °C	14,0 kg	425527202
REX-H/2-190-012S 2G	750 m³/h	350 Pa	2 880 rpm	230 V	1,3 A	120 W	68 dB(A)	-20 / 60 °C	-20 / 50 °C	15,0 kg	45527203
REX-H/2-190-012S 2GD	750 m³/h	350 Pa	2 880 rpm	230 V	1,3 A	120 W	68 dB(A)	-20 / 60 °C	-20 / 50 °C	15,0 kg	45527204
REX-H/2-220-012T 2G	1 050 m³/h	450 Pa	2 750 rpm	400 V	0,4 A	120 W	69 dB(A)	-20 / 60 °C	-20 / 40 °C	12,0 kg	45527210
REX-H/2-220-012T 2G VFD	1 050 m³/h	450 Pa	2 800 rpm	400 V	0,48 A	120 W	69 dB(A)	-20 / 60 °C	-20 / 50 °C	14,0 kg	425527211
REX-H/2-220-012T 2GD VFD	1 050 m³/h	450 Pa	2 800 rpm	400 V	0,48 A	120 W	69 dB(A)	-20 / 60 °C	-20 / 50 °C	14,0 kg	425527212
REX-H/2-220-012S 2G	1 050 m³/h	450 Pa	2 880 rpm	230 V	1,3 A	120 W	69 dB(A)	-20 / 60 °C	-20 / 50 °C	15,0 kg	45527213
REX-H/2-220-012S 2GD	1 050 m³/h	450 Pa	2 880 rpm	230 V	1,3 A	120 W	69 dB(A)	-20 / 60 °C	-20 / 50 °C	15,0 kg	45527214
REX-H/2-280(250)-025T 2G	1 800 m³/h	650 Pa	2 870 rpm	400 V	0,9 A	250 W	72 dB(A)	-20 / 60 °C	-20 / 40 °C	15,0 kg	45527220
REX-H/2-280(250)-025T 2G VFD	1 800 m³/h	650 Pa	2 830 rpm	400 V	0,81 A	250 W	72 dB(A)	-20 / 60 °C	-20 / 50 °C	17,0 kg	425527221
REX-H/2-280(250)-025T 2GD VFD	1 800 m³/h	650 Pa	2 830 rpm	400 V	0,81 A	250 W	72 dB(A)	-20 / 60 °C	-20 / 50 °C	17,0 kg	425527222
REX-H/2-280(250)-025S 2G	1 800 m³/h	650 Pa	2 800 rpm	230 V	1,81 A	250 W	72 dB(A)	-20 / 60 °C	-20 / 50 °C	17,0 kg	45527223
REX-H/2-280(250)-025S 2GD	1 800 m³/h	650 Pa	2 800 rpm	230 V	1,81 A	250 W	72 dB(A)	-20 / 60 °C	-20 / 50 °C	17,0 kg	45527224
<b>4-POLIGE MOTOREN 1500RPM</b>											
REX-H/4-190-006T 2G	370 m³/h	85 Pa	1 380 rpm	400 V	0,31 A	60 W	53 dB(A)	-20 / 60 °C	-20 / 40 °C	12,0 kg	45527400
REX-H/4-190-012T 2G VFD	370 m³/h	85 Pa	1 390 rpm	400 V	0,49 A	120 W	53 dB(A)	-20 / 60 °C	-20 / 50 °C	14,5 kg	425527401
REX-H/4-190-012T 2GD VFD	370 m³/h	85 Pa	1 390 rpm	400 V	0,49 A	120 W	53 dB(A)	-20 / 60 °C	-20 / 50 °C	14,5 kg	425527402
REX-H/4-190-009S 2G	370 m³/h	85 Pa	1 420 rpm	230 V	0,8 A	90 W	53 dB(A)	-20 / 60 °C	-20 / 50 °C	15,0 kg	45527403
REX-H/4-190-009S 2GD	370 m³/h	85 Pa	1 420 rpm	230 V	0,8 A	90 W	53 dB(A)	-20 / 60 °C	-20 / 50 °C	15,0 kg	45527404
REX-H/4-220-006T 2G	515 m³/h	110 Pa	1 380 rpm	400 V	0,31 A	60 W	54 dB(A)	-20 / 60 °C	-20 / 40 °C	12,0 kg	45527410
REX-H/4-220-012T 2G VFD	515 m³/h	110 Pa	1 390 rpm	400 V	0,49 A	120 W	54 dB(A)	-20 / 60 °C	-20 / 50 °C	14,5 kg	425527411
REX-H/4-220-012T 2GD VFD	515 m³/h	110 Pa	1 390 rpm	400 V	0,49 A	120 W	54 dB(A)	-20 / 60 °C	-20 / 50 °C	14,5 kg	425527412
REX-H/4-220-009S 2G	515 m³/h	110 Pa	1 420 rpm	230 V	0,8 A	90 W	54 dB(A)	-20 / 60 °C	-20 / 50 °C	15,0 kg	45527413
REX-H/4-220-009S 2GD	515 m³/h	110 Pa	1 420 rpm	230 V	0,8 A	90 W	54 dB(A)	-20 / 60 °C	-20 / 50 °C	15,0 kg	45527414
REX-H/4-250-018T 2G	1 140 m³/h	185 Pa	1 390 rpm	400 V	0,7 A	180 W	54 dB(A)	-20 / 60 °C	-20 / 40 °C	16,0 kg	45527420
REX-H/4-250-018T 2G VFD	1 140 m³/h	185 Pa	1 340 rpm	400 V	0,57 A	180 W	54 dB(A)	-20 / 60 °C	-20 / 50 °C	17,0 kg	425527421
REX-H/4-250-018T 2GD VFD	1 140 m³/h	185 Pa	1 340 rpm	400 V	0,57 A	180 W	54 dB(A)	-20 / 60 °C	-20 / 50 °C	17,0 kg	425527422
REX-H/4-250-018S 2G	1 140 m³/h	185 Pa	1 355 rpm	230 V	1,38 A	180 W	54 dB(A)	-20 / 60 °C	-20 / 50 °C	18,0 kg	45527423
REX-H/4-250-018S 2GD	1 140 m³/h	185 Pa	1 355 rpm	230 V	1,38 A	180 W	54 dB(A)	-20 / 60 °C	-20 / 50 °C	18,0 kg	45527424
REX-H/4-280-025T 2G	1 615 m³/h	235 Pa	1 370 rpm	400 V	0,85 A	250 W	57 dB(A)	-20 / 60 °C	-20 / 40 °C	17,0 kg	45527430
REX-H/4-280-025T 2G VFD	1 615 m³/h	235 Pa	1 430 rpm	400 V	0,79 A	250 W	57 dB(A)	-20 / 60 °C	-20 / 50 °C	19,0 kg	425527431
REX-H/4-280-025T 2GD VFD	1 615 m³/h	235 Pa	1 430 rpm	400 V	0,79 A	250 W	57 dB(A)	-20 / 60 °C	-20 / 50 °C	19,0 kg	425527432
REX-H/4-280-025S 2G	1 615 m³/h	235 Pa	1 450 rpm	230 V	2 A	250 W	57 dB(A)	-20 / 60 °C	-20 / 50 °C	20,0 kg	45527433
REX-H/4-280-025S 2GD	1 615 m³/h	235 Pa	1 450 rpm	230 V	2 A	250 W	57 dB(A)	-20 / 60 °C	-20 / 50 °C	20,0 kg	45527434
REX-H/4-315-037T 2G	2 280 m³/h	300 Pa	1 350 rpm	400 V	1,15 A	370 W	60 dB(A)	-20 / 60 °C	-20 / 40 °C	23,0 kg	45527440
REX-H/4-315-037T 2G VFD	2 280 m³/h	300 Pa	1 420 rpm	400 V	1,08 A	370 W	60 dB(A)	-20 / 60 °C	-20 / 50 °C	24,0 kg	425527441
REX-H/4-315-037T 2GD VFD	2 280 m³/h	300 Pa	1 420 rpm	400 V	1,08 A	370 W	60 dB(A)	-20 / 60 °C	-20 / 50 °C	23,0 kg	425527442
REX-H/4-315-037S 2G	2 280 m³/h	300 Pa	1 430 rpm	230 V	2,55 A	370 W	60 dB(A)	-20 / 60 °C	-20 / 50 °C	25,5 kg	45527443
REX-H/4-315-037S 2GD	2 280 m³/h	300 Pa	1 430 rpm	230 V	2,55 A	370 W	60 dB(A)	-20 / 60 °C	-20 / 50 °C	25,5 kg	45527444
REX-H/4-355-055T 2G	3 230 m³/h	385 Pa	1 360 rpm	400 V	1,5 A	550 W	63 dB(A)	-20 / 60 °C	-20 / 40 °C	30,5 kg	45527450
REX-H/4-355-055T 2G VFD	3 230 m³/h	385 Pa	1 440 rpm	400 V	1,32 A	550 W	63 dB(A)	-20 / 60 °C	-20 / 50 °C	33,0 kg	425527451
REX-H/4-355-055T 2GD VFD	3 230 m³/h	385 Pa	1 440 rpm	400 V	1,32 A	550 W	63 dB(A)	-20 / 60 °C	-20 / 50 °C	33,0 kg	425527452

\* Messung in 1,5 m Entfernung vom Auslass, für Q = 2/3 \* Qmax

\*\* Der Nennstrom ist abhängig von eingesetztem Motorfabrikat.

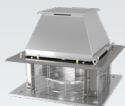

## NENNDATEN

Typ	Volumenstrom max	Druck max	Motor Drehzahl	Nennspannung	Nennstrom**	Motorleistung	Schalldruckpegel Fall*	Temp.-betrieb min / max	Temp.-umgebungs min / max	Gewicht	Artikelnummer
REX-H/4-355-055S 2G	3 230 m³/h	385 Pa	1 440 rpm	230 V	3,7 A	550 W	63 dB(A)	-20 / 60 °C	-20 / 50 °C	33,0 kg	45527453
REX-H/4-355-055S 2GD	3 230 m³/h	385 Pa	1 440 rpm	230 V	3,7 A	550 W	63 dB(A)	-20 / 60 °C	-20 / 50 °C	33,0 kg	45527454
REX-H/4-400-075T 2G	4 750 m³/h	490 Pa	1 360 rpm	400 V	1,9 A	750 W	66 dB(A)	-20 / 60 °C	-20 / 40 °C	38,0 kg	45527460
REX-H/4-400-075T 2G VFD	4 750 m³/h	490 Pa	1 445 rpm	400 V	1,85 A	750 W	66 dB(A)	-20 / 60 °C	-20 / 50 °C	42,0 kg	435527461
REX-H/4-400-075T 2GD VFD	4 750 m³/h	490 Pa	1 445 rpm	400 V	1,85 A	750 W	66 dB(A)	-20 / 60 °C	-20 / 50 °C	42,0 kg	435527462
REX-H/4-400-075S 2G	4 750 m³/h	490 Pa	1 410 rpm	230 V	4,74 A	750 W	66 dB(A)	-20 / 60 °C	-20 / 50 °C	41,0 kg	45527463
REX-H/4-400-075S 2GD	4 750 m³/h	490 Pa	1 410 rpm	230 V	4,74 A	750 W	66 dB(A)	-20 / 60 °C	-20 / 50 °C	41,0 kg	45527464
REX-H/4-450-110T 2G	6 745 m³/h	640 Pa	1 405 rpm	400 V	2,7 A	1100 W	69 dB(A)	-20 / 60 °C	-20 / 40 °C	49,0 kg	45527470
REX-H/4-450-110T 2G VFD	6 745 m³/h	640 Pa	1 440 rpm	400 V	2,61 A	1100 W	69 dB(A)	-20 / 60 °C	-20 / 50 °C	52,0 kg	435527471
REX-H/4-450-110T 2GD VFD	6 745 m³/h	640 Pa	1 440 rpm	400 V	2,61 A	1100 W	69 dB(A)	-20 / 60 °C	-20 / 50 °C	52,0 kg	435527472
REX-H/4-450-110S 2G	6 745 m³/h	640 Pa	1 440 rpm	230 V	7,6 A	1100 W	69 dB(A)	-20 / 60 °C	-20 / 50 °C	51,0 kg	45527473
REX-H/4-450-110S 2GD	6 745 m³/h	640 Pa	1 440 rpm	230 V	7,6 A	1100 W	69 dB(A)	-20 / 60 °C	-20 / 50 °C	51,0 kg	45527474
REX-H/4-500-220T 2G	9 215 m³/h	765 Pa	1 425 rpm	400 V	5,2 A	2200 W	72 dB(A)	-20 / 60 °C	-20 / 40 °C	64,5 kg	45527480
REX-H/4-500-220T 2G VFD	9 215 m³/h	765 Pa	1 440 rpm	400 V	4,9 A	2200 W	72 dB(A)	-20 / 60 °C	-20 / 50 °C	68,5 kg	435527481
REX-H/4-500-220T 2GD VFD	9 215 m³/h	765 Pa	1 440 rpm	400 V	4,9 A	2200 W	72 dB(A)	-20 / 60 °C	-20 / 50 °C	68,5 kg	435527482
REX-H/4-560-300T 2G	12 900 m³/h	950 Pa	1 415 rpm	400 V	6,9 A	3000 W	76 dB(A)	-20 / 60 °C	-20 / 40 °C	74,0 kg	45527490
REX-H/4-560-300T 2G VFD	12 900 m³/h	950 Pa	1 455 rpm	400 V	6,05 A	3000 W	76 dB(A)	-20 / 60 °C	-20 / 50 °C	84,0 kg	435527491
REX-H/4-560-300T 2GD VFD	12 900 m³/h	950 Pa	1 455 rpm	400 V	6,05 A	3000 W	76 dB(A)	-20 / 60 °C	-20 / 50 °C	84,0 kg	435527492

### 6-POLIGE MOTOREN 1000RPM

REX-H/6-250-018T 2G	750 m³/h	80 Pa	880 rpm	400 V	0,7 A	180 W	51 dB(A)	-20 / 60 °C	-20 / 40 °C	16,5 kg	45527620
REX-H/6-250-012T 2G VFD	750 m³/h	80 Pa	935 rpm	400 V	0,59 A	120 W	51 dB(A)	-20 / 60 °C	-20 / 50 °C	18,0 kg	425527621
REX-H/6-250-012T 2GD VFD	750 m³/h	80 Pa	935 rpm	400 V	0,59 A	120 W	51 dB(A)	-20 / 60 °C	-20 / 50 °C	18,0 kg	425527622
REX-H/6-280-018T 2G	1 060 m³/h	100 Pa	880 rpm	400 V	0,7 A	180 W	54 dB(A)	-20 / 60 °C	-20 / 40 °C	17,0 kg	45527630
REX-H/6-280-012T 2G VFD	1 060 m³/h	100 Pa	935 rpm	400 V	0,59 A	120 W	54 dB(A)	-20 / 60 °C	-20 / 50 °C	18,0 kg	425527631
REX-H/6-280-012T 2GD VFD	1 060 m³/h	100 Pa	935 rpm	400 V	0,59 A	120 W	54 dB(A)	-20 / 60 °C	-20 / 50 °C	18,0 kg	425527632
REX-H/6-315-018T 2G	1 500 m³/h	130 Pa	880 rpm	400 V	0,7 A	180 W	57 dB(A)	-20 / 60 °C	-20 / 40 °C	22,0 kg	45527640
REX-H/6-315-012T 2G VFD	1 500 m³/h	130 Pa	935 rpm	400 V	0,59 A	120 W	57 dB(A)	-20 / 60 °C	-20 / 50 °C	23,0 kg	425527641
REX-H/6-315-012T 2GD VFD	1 500 m³/h	130 Pa	935 rpm	400 V	0,59 A	120 W	57 dB(A)	-20 / 60 °C	-20 / 50 °C	23,0 kg	425527642
REX-H/6-355-018T 2G	2 115 m³/h	165 Pa	880 rpm	400 V	0,7 A	180 W	60 dB(A)	-20 / 60 °C	-20 / 40 °C	28,0 kg	45527650
REX-H/6-355-018T 2G VFD	2 115 m³/h	165 Pa	925 rpm	400 V	0,82 A	180 W	60 dB(A)	-20 / 60 °C	-20 / 50 °C	30,0 kg	425527651
REX-H/6-355-018T 2GD VFD	2 115 m³/h	165 Pa	925 rpm	400 V	0,82 A	180 W	60 dB(A)	-20 / 60 °C	-20 / 50 °C	30,0 kg	425527652
REX-H/6-400-025T 2G	3 110 m³/h	210 Pa	900 rpm	400 V	0,85 A	250 W	63 dB(A)	-20 / 60 °C	-20 / 40 °C	35,0 kg	45527660
REX-H/6-400-025T 2G VFD	3 110 m³/h	210 Pa	930 rpm	400 V	0,88 A	250 W	63 dB(A)	-20 / 60 °C	-20 / 50 °C	37,0 kg	425527661
REX-H/6-400-025T 2GD VFD	3 110 m³/h	210 Pa	930 rpm	400 V	0,88 A	250 W	63 dB(A)	-20 / 60 °C	-20 / 50 °C	37,0 kg	425527662
REX-H/6-450-037T 2G	4 420 m³/h	275 Pa	920 rpm	400 V	1,3 A	370 W	66 dB(A)	-20 / 60 °C	-20 / 40 °C	44,0 kg	45527670
REX-H/6-450-037T 2G VFD	4 420 m³/h	275 Pa	945 rpm	400 V	1,05 A	370 W	66 dB(A)	-20 / 60 °C	-20 / 50 °C	47,0 kg	425527671
REX-H/6-450-037T 2GD VFD	4 420 m³/h	275 Pa	945 rpm	400 V	1,05 A	370 W	66 dB(A)	-20 / 60 °C	-20 / 50 °C	47,0 kg	425527672
REX-H/6-500-075T 2G	6 030 m³/h	330 Pa	915 rpm	400 V	2,1 A	750 W	69 dB(A)	-20 / 60 °C	-20 / 40 °C	60,0 kg	45527680
REX-H/6-500-075T 2G VFD	6 030 m³/h	330 Pa	945 rpm	400 V	1,96 A	750 W	69 dB(A)	-20 / 60 °C	-20 / 50 °C	60,0 kg	435527681
REX-H/6-500-075T 2GD VFD	6 030 m³/h	330 Pa	945 rpm	400 V	1,96 A	750 W	69 dB(A)	-20 / 60 °C	-20 / 50 °C	60,0 kg	435527682
REX-H/6-560-110T 2G	8 465 m³/h	410 Pa	920 rpm	400 V	3 A	1100 W	73 dB(A)	-20 / 60 °C	-20 / 40 °C	65,5 kg	45527690
REX-H/6-560-110T 2G VFD	8 465 m³/h	410 Pa	950 rpm	400 V	2,7 A	1100 W	73 dB(A)	-20 / 60 °C	-20 / 50 °C	72,0 kg	435527691
REX-H/6-560-110T 2GD VFD	8 465 m³/h	410 Pa	950 rpm	400 V	2,7 A	1100 W	73 dB(A)	-20 / 60 °C	-20 / 50 °C	72,0 kg	435527692
REX-H/6-630-220T 2G	12 250 m³/h	535 Pa	960 rpm	400 V	5,1 A	2200 W	77 dB(A)	-20 / 60 °C	-20 / 40 °C	111,0 kg	45527700
REX-H/6-630-220T 2G VFD	12 250 m³/h	535 Pa	955 rpm	400 V	5,2 A	2200 W	77 dB(A)	-20 / 60 °C	-20 / 50 °C	122,0 kg	435527701

\* Messung in 1,5 m Entfernung vom Auslass, für Q = 2/3 \* Qmax

\*\* Der Nennstrom ist abhängig von eingesetztem Motorfabrikat.

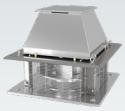

## NENNDATEN

Typ	Volumenstrom max	Druck max	Motor Drehzahl	Nennspannung	Nennstrom**	Motorleistung	Schall-druckpegel Fall*	Temp.-betrieb min / max	Temp.-umgebungs min / max	Gewicht	Artikelnummer
REX-H/6-630-220T 2GD VFD	12 250 m³/h	535 Pa	955 rpm	400 V	5,2 A	2200 W	77 dB(A)	-20 / 60 °C	-20 / 50 °C	122,0 kg	435527702
REX-H/6-710-300T 2G	17 480 m³/h	680 Pa	950 rpm	400 V	6,8 A	3000 W	81 dB(A)	-20 / 60 °C	-20 / 40 °C	152,0 kg	45527710
REX-H/6-710-300T 2G VFD	17 480 m³/h	680 Pa	965 rpm	400 V	6,32 A	3000 W	81 dB(A)	-20 / 60 °C	-20 / 50 °C	147,0 kg	435527711
REX-H/6-710-300T 2GD VFD	17 480 m³/h	680 Pa	965 rpm	400 V	6,32 A	3000 W	81 dB(A)	-20 / 60 °C	-20 / 50 °C	147,0 kg	435527712
REX-H/6-800-550T 2G	26000 m³/h	900 Pa	950 rpm	400 V	11,6 A	5500 W	85 dB(A)	-20 / 60 °C	-20 / 40 °C	210,0 kg	45527720
REX-H/6-800-550T 2G VFD	26000 m³/h	900 Pa	970 rpm	400 V	11,4 A	5500 W	85 dB(A)	-20 / 60 °C	-20 / 50 °C	242,0 kg	435527721
REX-H/6-800-550T 2GD VFD	26000 m³/h	900 Pa	970 rpm	400 V	11,4 A	5500 W	85 dB(A)	-20 / 60 °C	-20 / 50 °C	242,0 kg	435527722

\* Messung in 1,5 m Entfernung vom Auslass, für  $Q = 2/3 * Q_{max}$

\*\* Der Nennstrom ist abhängig von eingesetztem Motorfabrikat.

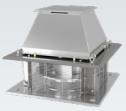

## LEISTUNGSMERKMALE DER VENTILATOREN - 2-POLIGE MOTOREN 3000RPM

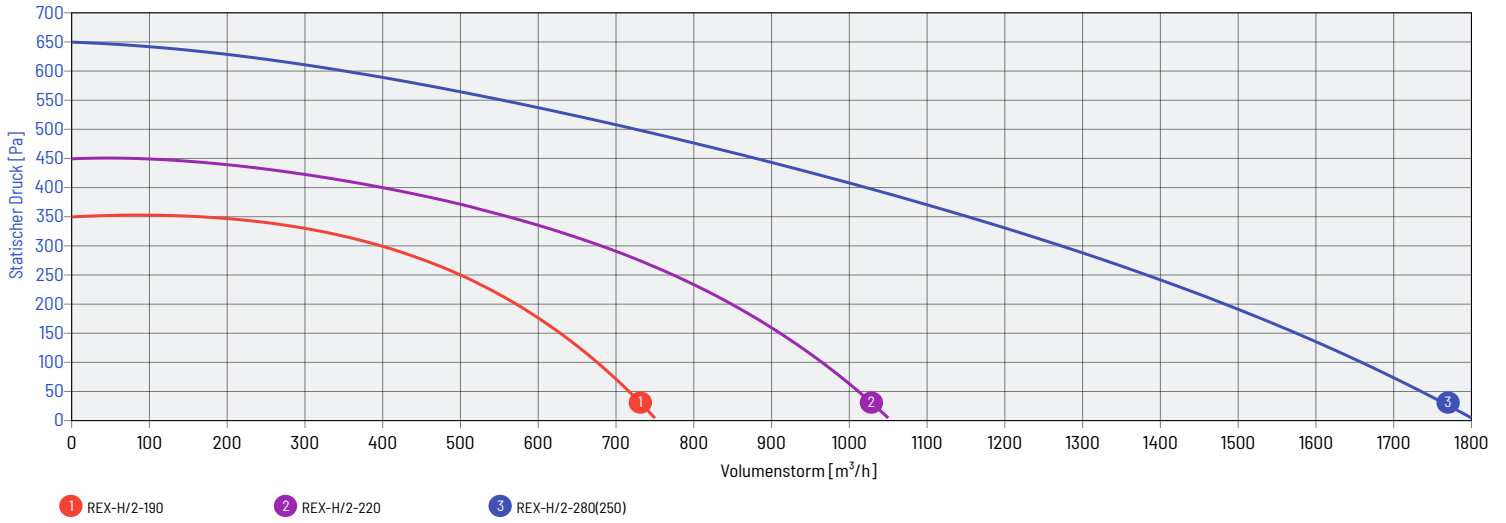

## LEISTUNGSMERKMALE DER VENTILATOREN - 4-POLIGE MOTOREN 1500RPM

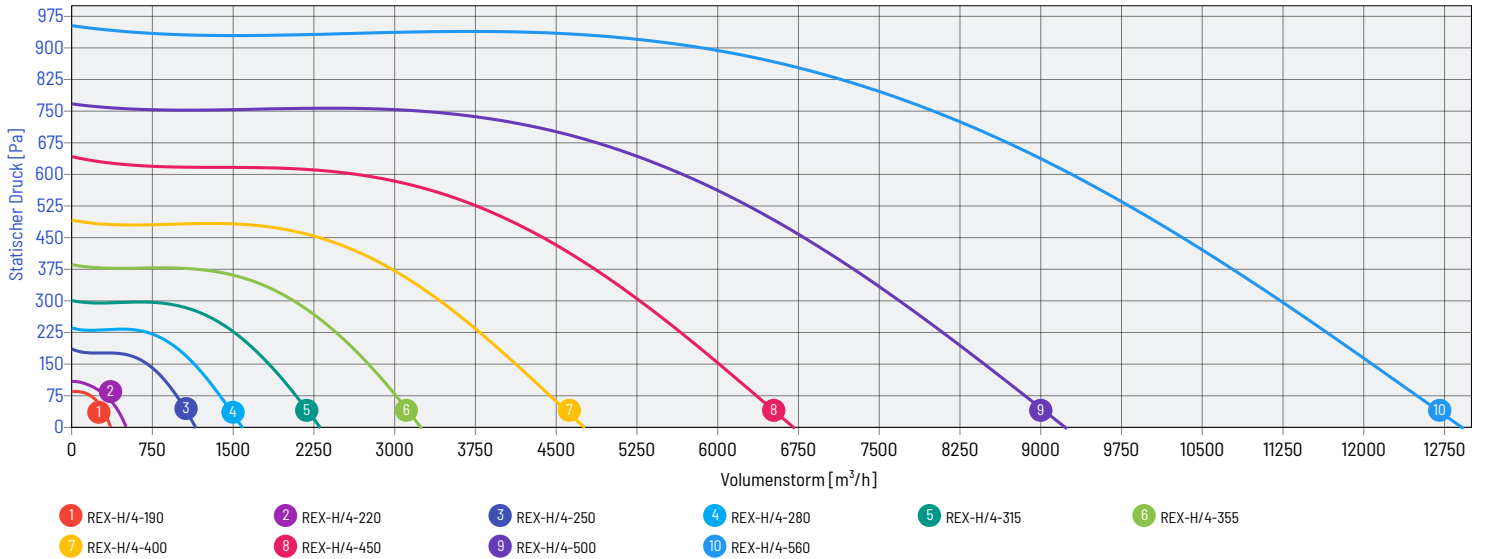

## LEISTUNGSMERKMALE DER VENTILATOREN - 6-POLIGE MOTOREN 1000RPM

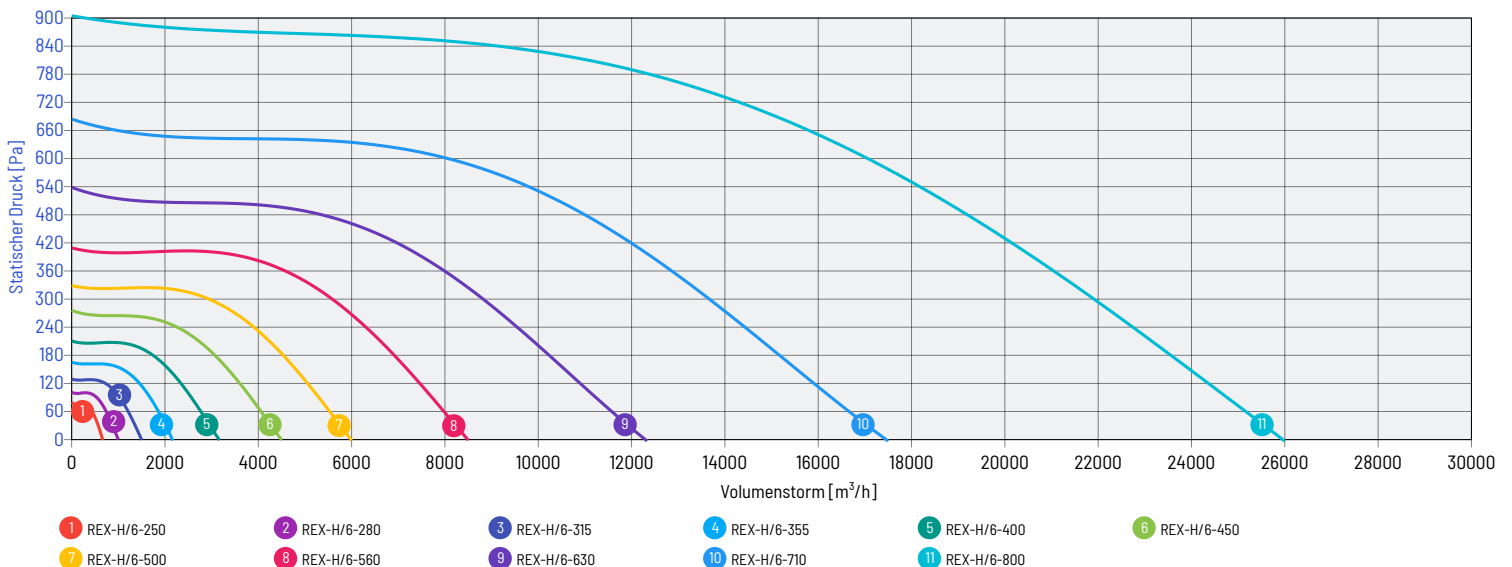

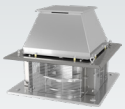

## KENNLINIEN DER VENTILATOREN

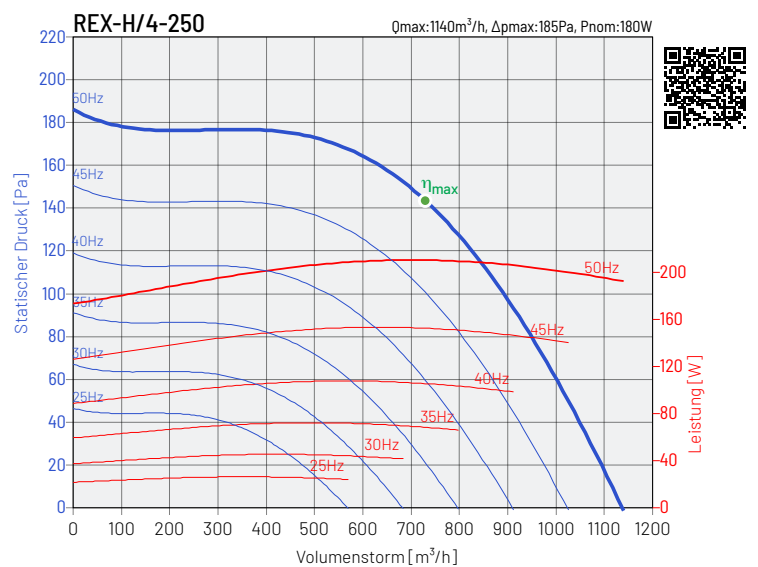
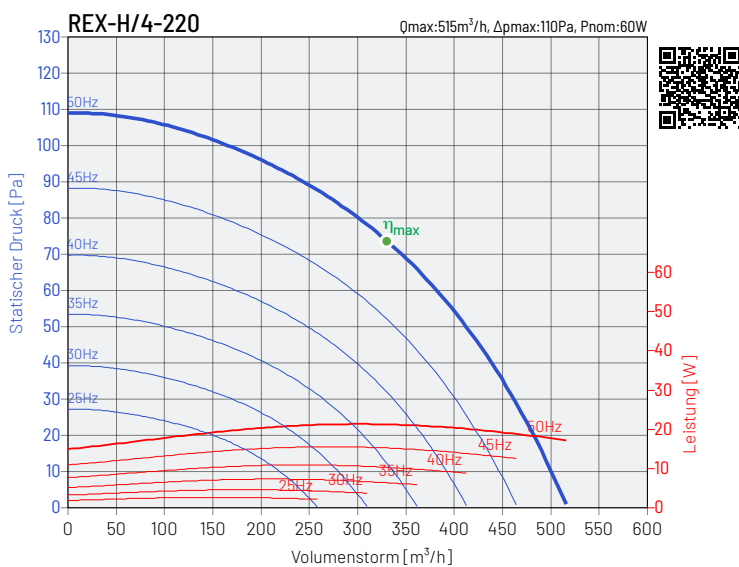
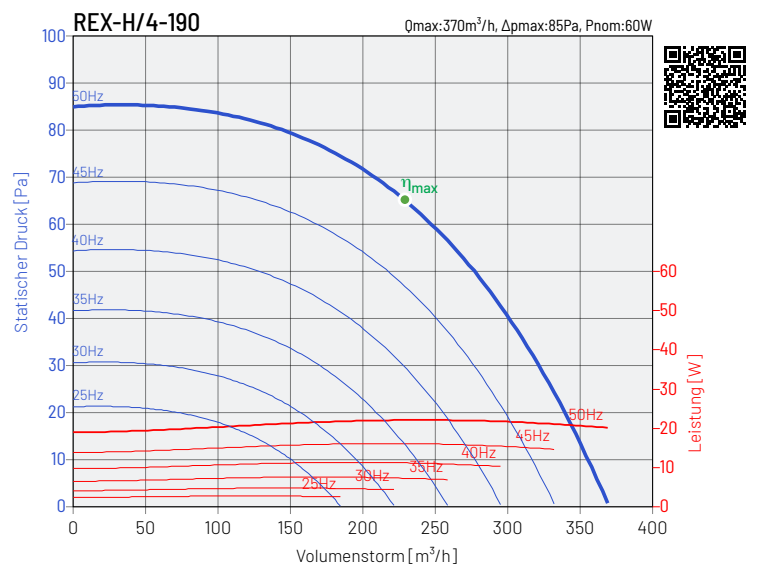
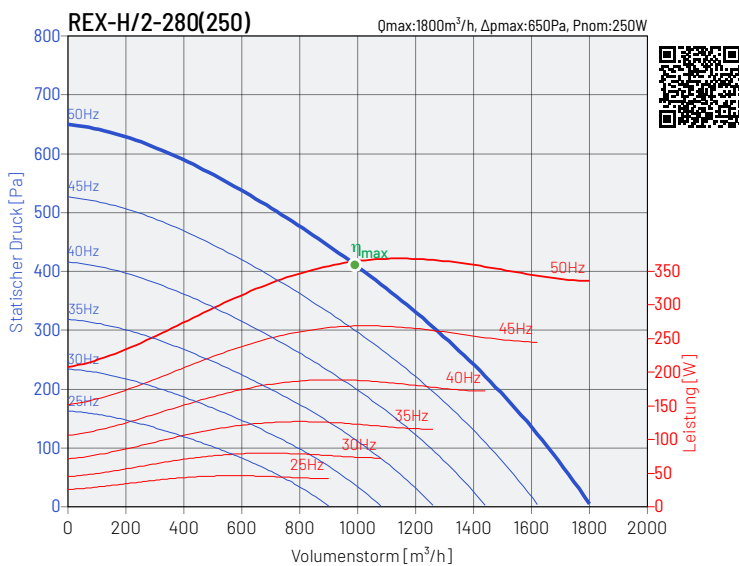
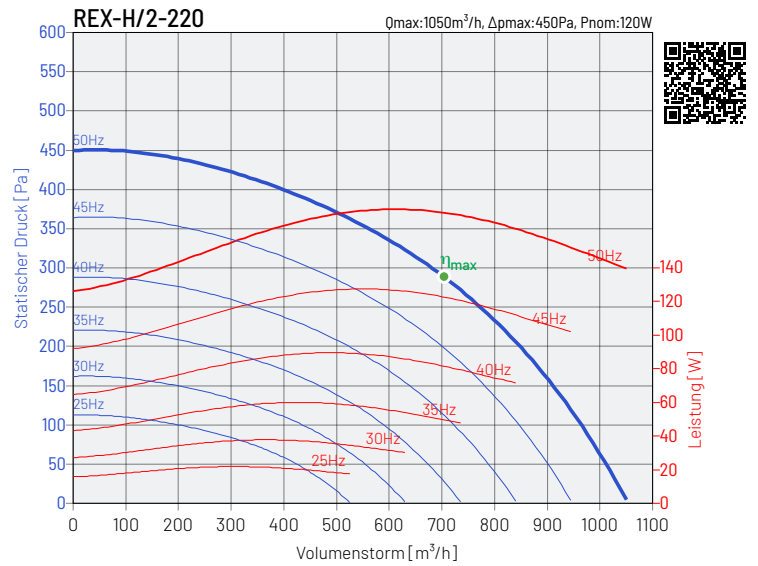
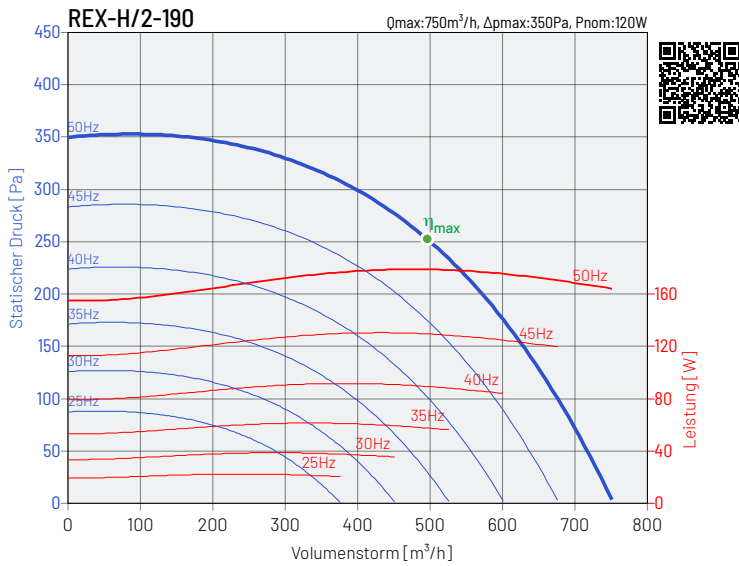

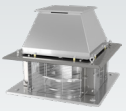

## KENNLINIEN DER VENTILATOREN

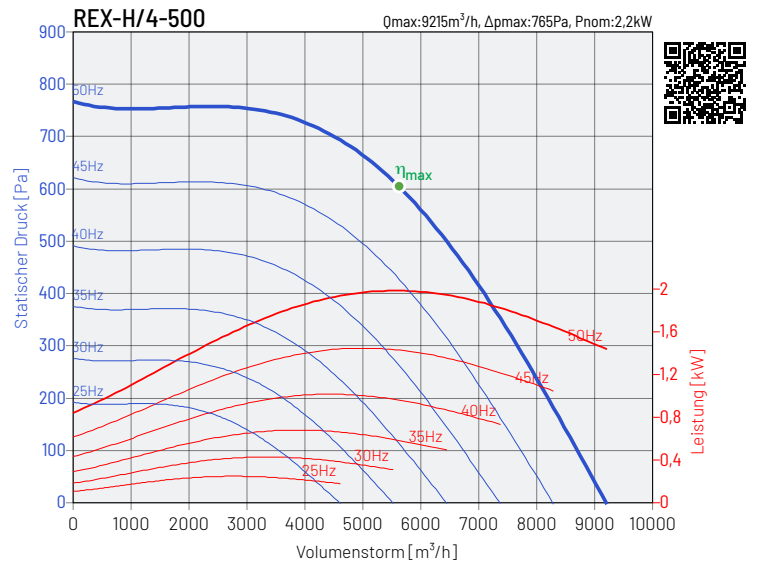
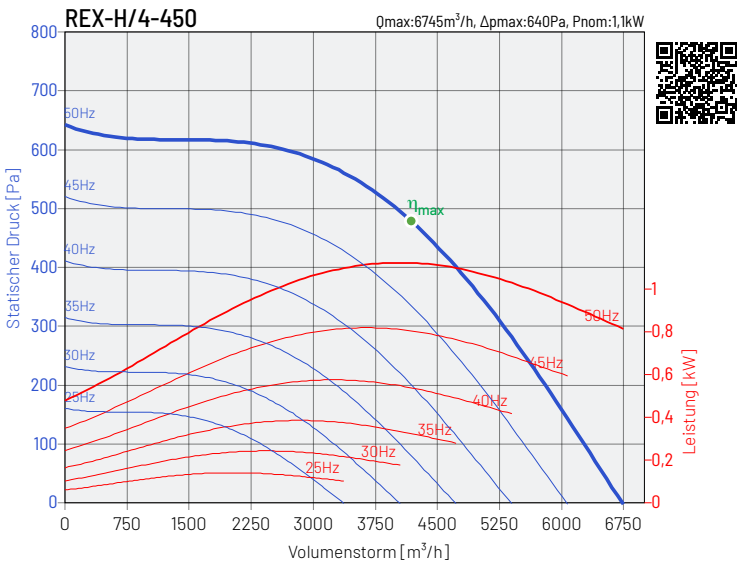
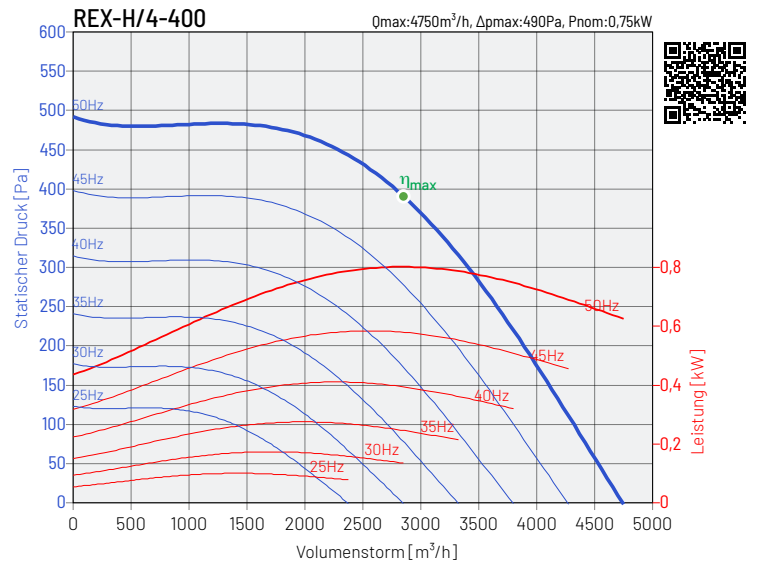
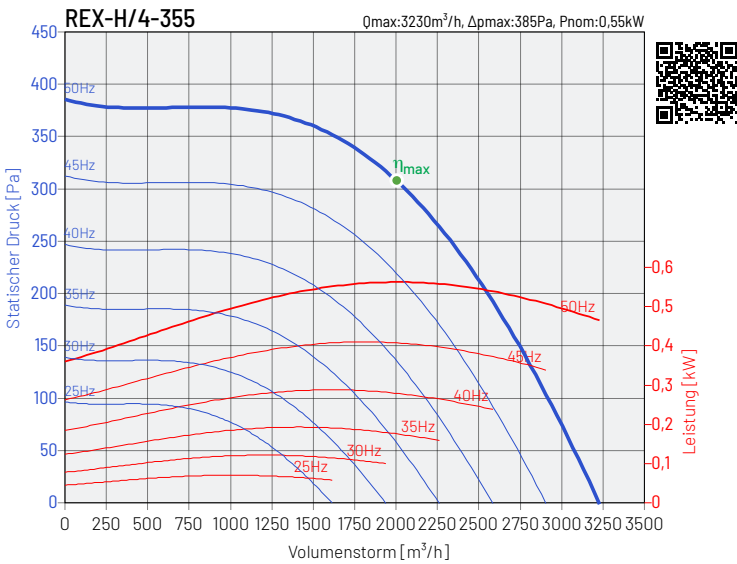
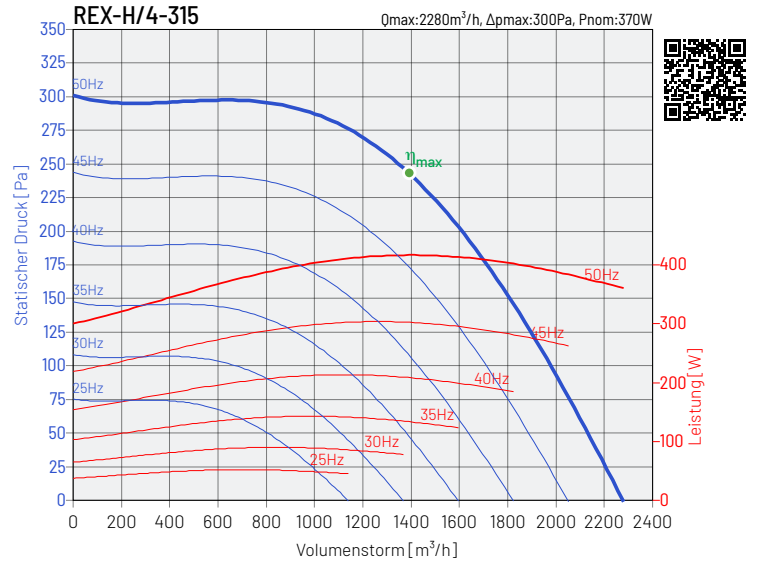
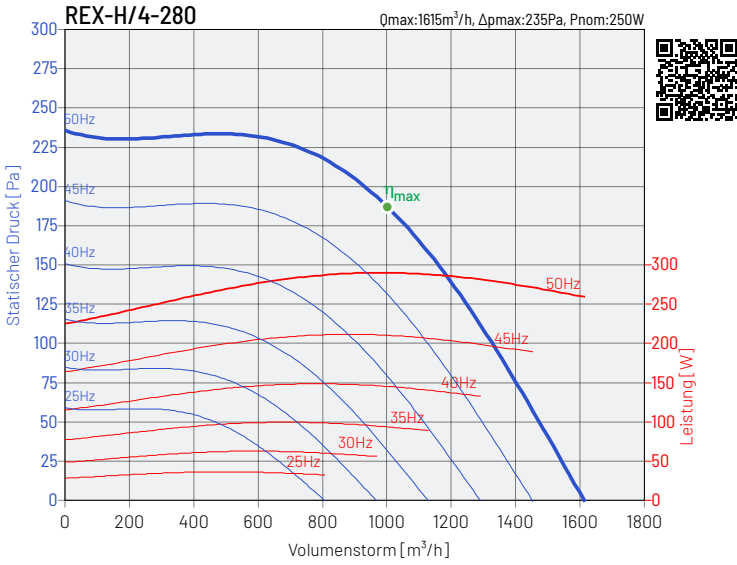

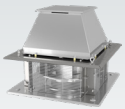

## KENNLINIEN DER VENTILATOREN

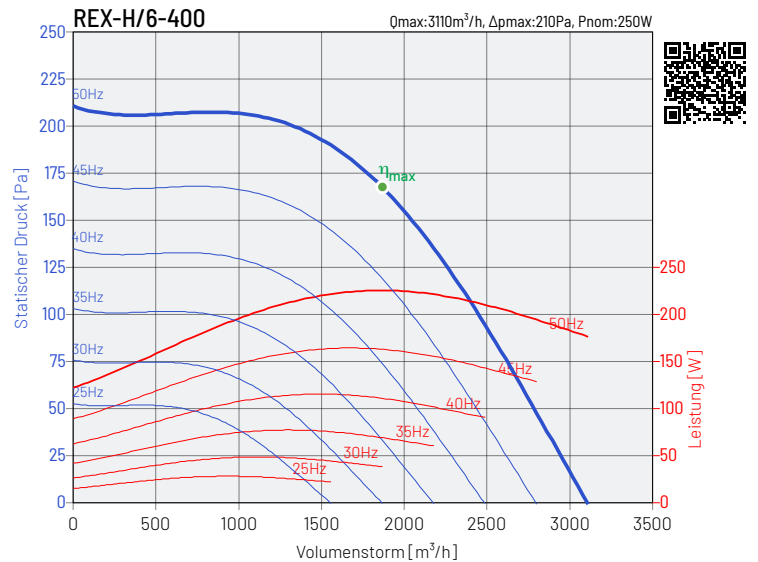
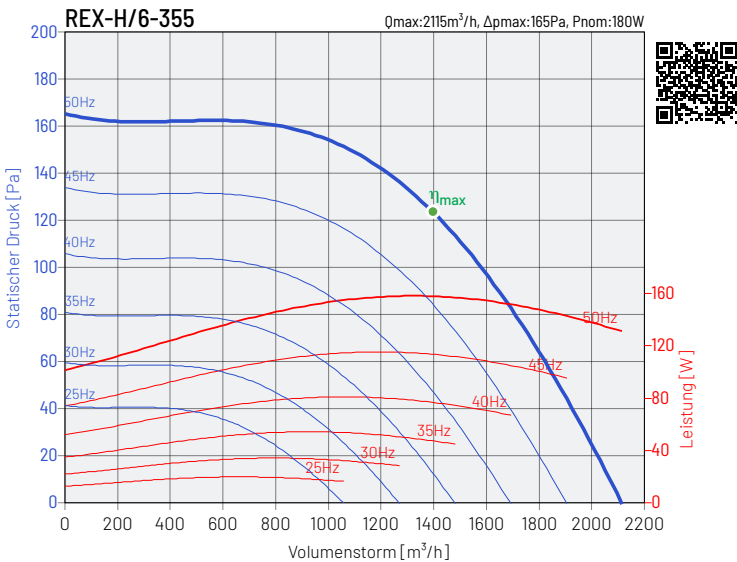
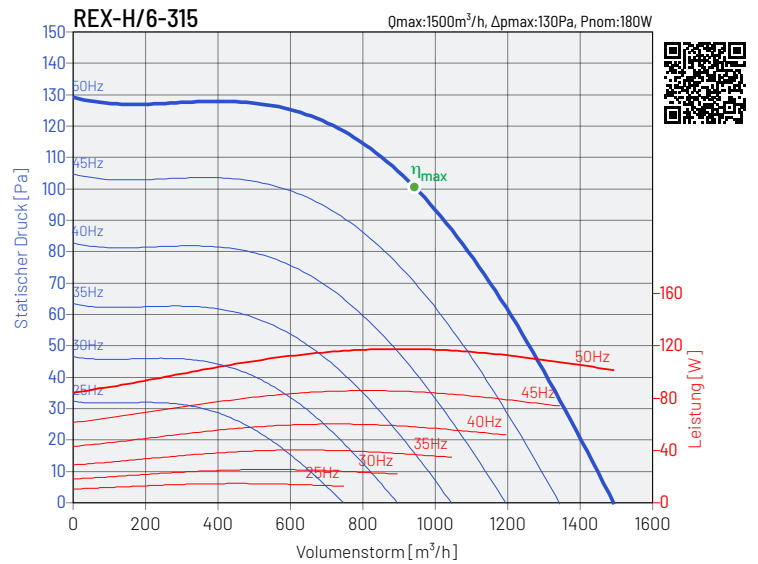
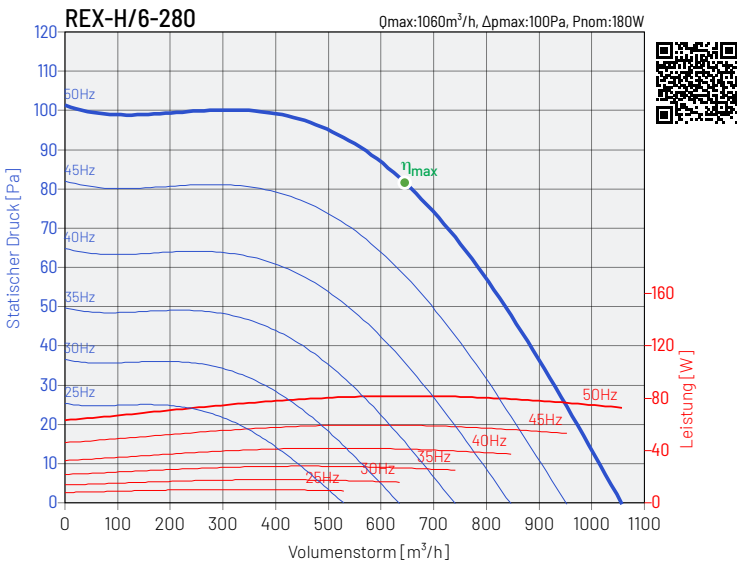
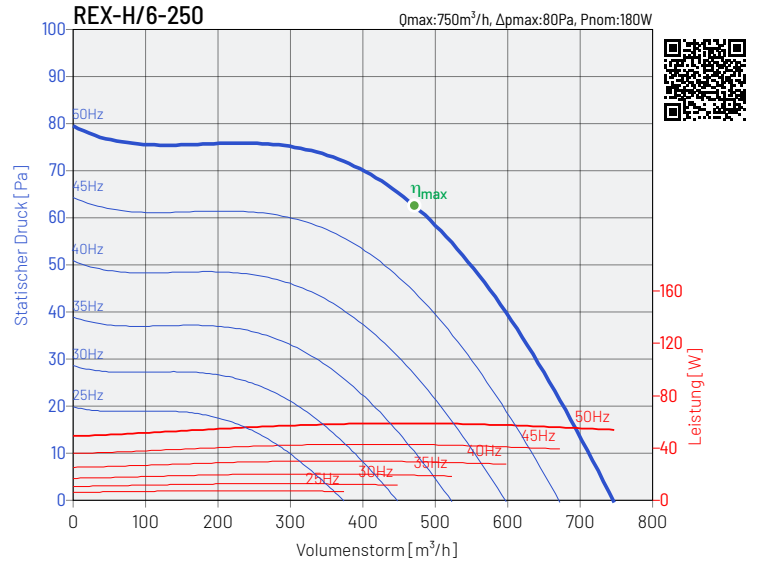
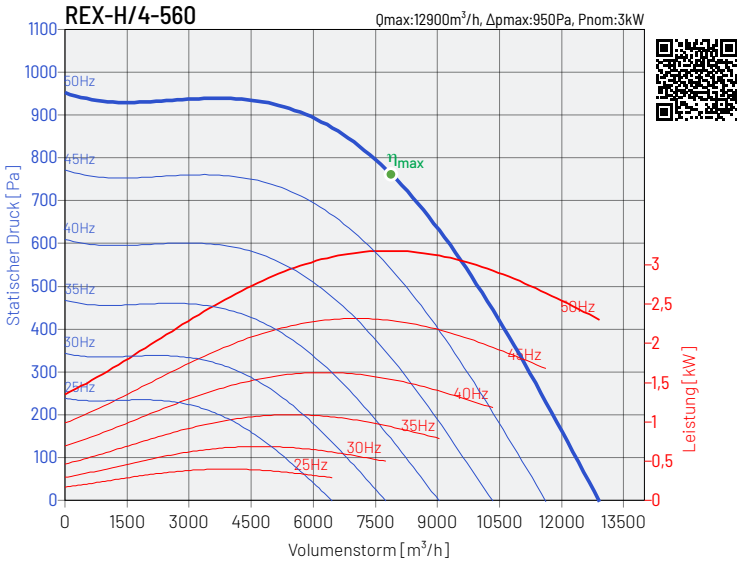



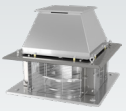

## KENNLINIEN DER VENTILATOREN

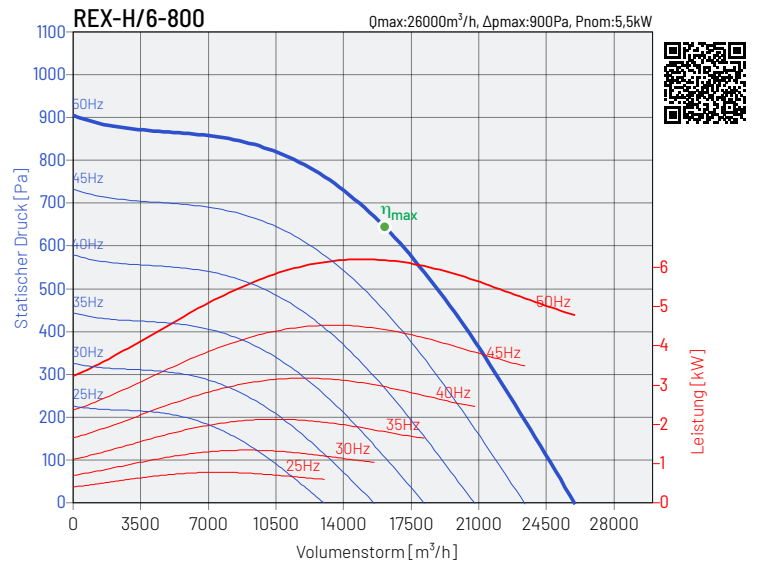
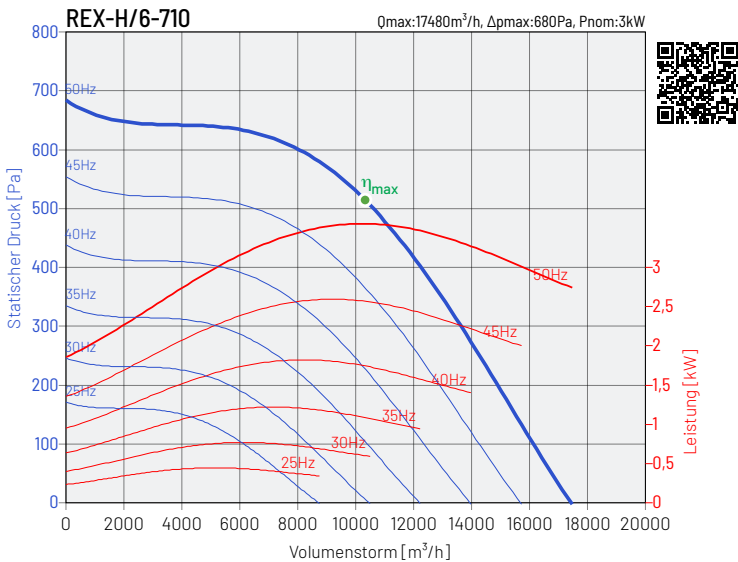
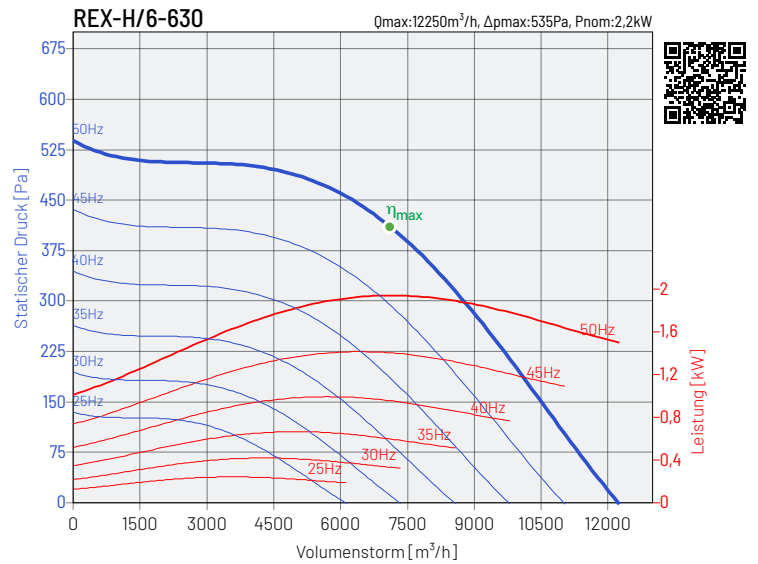
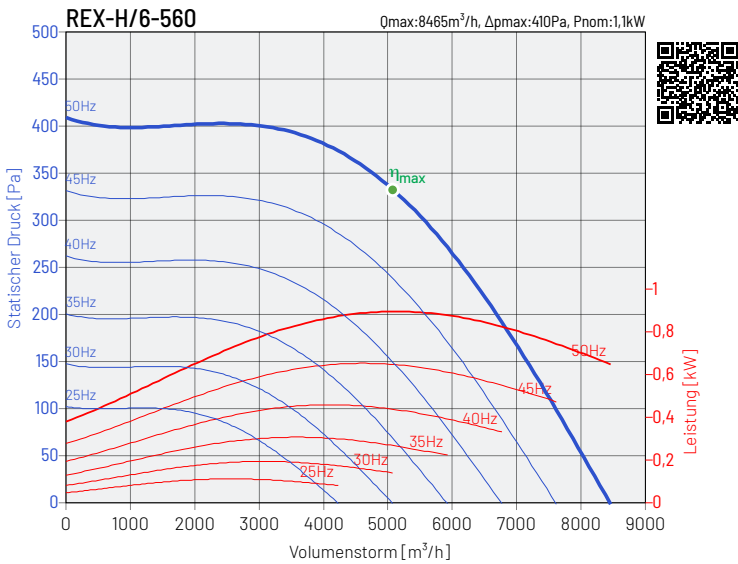
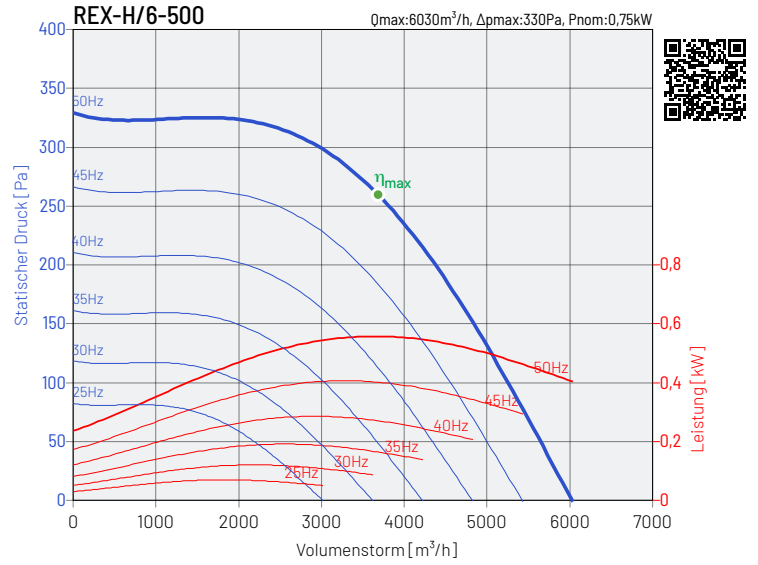
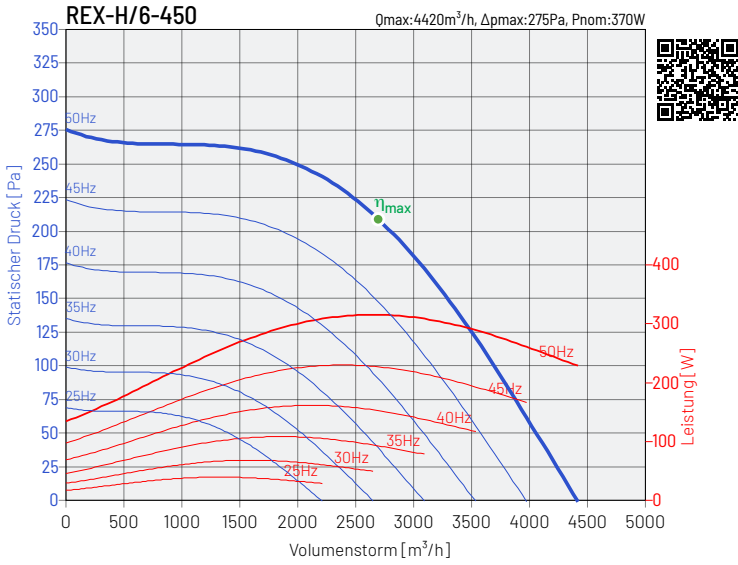

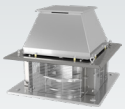

## ABMESSUNGEN

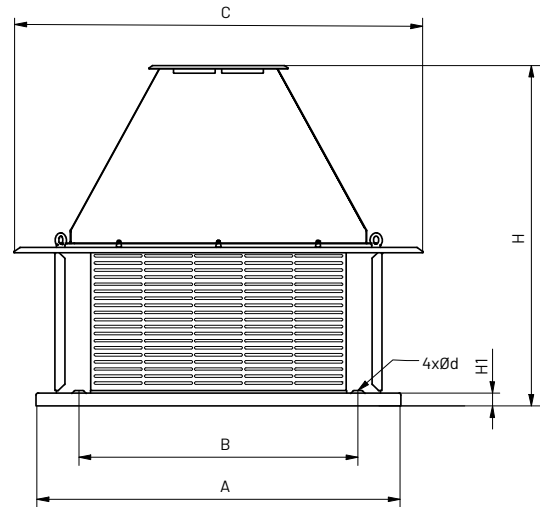
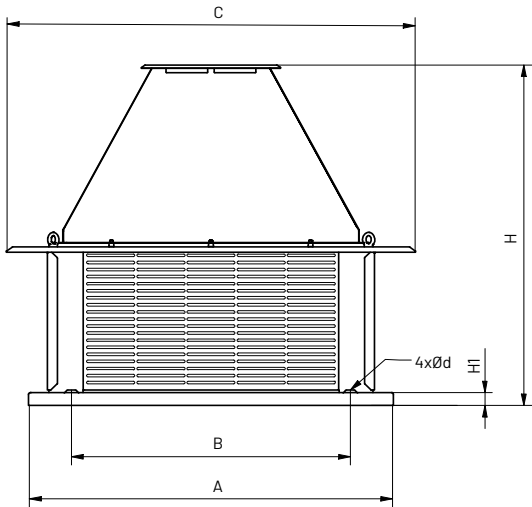

Typ	A mm	B mm	C mm	Ød mm	H mm	H1 mm
REX-x-190	435	330	386	12	385	15
REX-x-220	435	330	386	12	385	15
REX-x-250	435	330	441	12	453	15
REX-2-280	435	330	441	12	416	15
REX-4-280	435	330	441	12	453	15
REX-x-315	560	450	513	12	495	15
REX-x-355	560	450	583	12	540	15

Typ	A mm	B mm	C mm	Ød mm	H mm	H1 mm
REX-x-400	560	450	653	12	554	15
REX-x-450	710	590	731	12	603	15
REX-x-500	710	590	811	12	707	15
REX-x-560	710	590	896	12	781	15
REX-x-630	900	750	1001	14	797	40
REX-x-710	900	750	1121	14	885	40
REX-x-800	1100	840	1241	14	1060	40

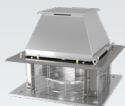

## MONTAGEZUBEHÖR

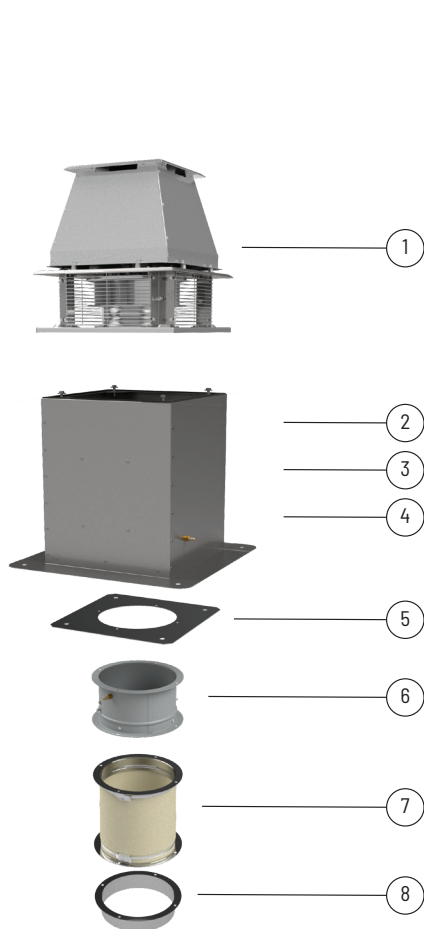

Typ	Dachsocket RSS/EX	Dachsocket RS/EX	Dachsocket RSA/EX	Montageplatte P/EX
REX-H/x-190	RSS/EX-435	RS/EX-435	RSA/EX-435	P/EX-435
REX-H/x-220	RSS/EX-435	RS/EX-435	RSA/EX-435	P/EX-435
REX-H/x-250	RSS/EX-435	RS/EX-435	RSA/EX-435	P/EX-435
REX-H/x-280	RSS/EX-435	RS/EX-435	RSA/EX-435	P/EX-435
REX-H/x-315	RSS/EX-560	RS/EX-560	RSA/EX-560	P/EX-560
REX-H/x-355	RSS/EX-560	RS/EX-560	RSA/EX-560	P/EX-560
REX-H/x-400	RSS/EX-560	RS/EX-560	RSA/EX-560	P/EX-560
REX-H/x-450	RSS/EX-710	RS/EX-710	RSA/EX-710	P/EX-710
REX-H/x-500	RSS/EX-710	RS/EX-710	RSA/EX-710	P/EX-710
REX-H/x-560	RSS/EX-710	RS/EX-710	RSA/EX-710	P/EX-710
REX-H/x-630	RSS/EX-900	RS/EX-900	RSA/EX-900	P/EX-900
REX-H/x-710	RSS/EX-900	RS/EX-900	RSA/EX-900	P/EX-900
REX-H/x-800	RSS/EX-1100	RS/EX-1100	RSA/EX-1100	P/EX-1100



Typ	Verschluss-flape KZD/EX	Mannschette ZPDO/EX	Gegenflansch K/EX
REX-H/x-190	KZD/EX-435	ZPDO/EX-435	K/EX-435
REX-H/x-220	KZD/EX-435	ZPDO/EX-435	K/EX-435
REX-H/x-250	KZD/EX-435	ZPDO/EX-435	K/EX-435
REX-H/x-280	KZD/EX-435	ZPDO/EX-435	K/EX-435
REX-H/x-315	KZD/EX-560	ZPDO/EX-560	K/EX-560
REX-H/x-355	KZD/EX-560	ZPDO/EX-560	K/EX-560
REX-H/x-400	KZD/EX-560	ZPDO/EX-560	K/EX-560
REX-H/x-450	KZD/EX-710	ZPDO/EX-710	K/EX-710
REX-H/x-500	KZD/EX-710	ZPDO/EX-710	K/EX-710
REX-H/x-560	KZD/EX-710	ZPDO/EX-710	K/EX-710
REX-H/x-630	KZD/EX-900	ZPDO/EX-900	K/EX-900
REX-H/x-710	KZD/EX-900	ZPDO/EX-900	K/EX-900
REX-H/x-800	KZD/EX-1100	ZPDO/EX-1100	K/EX-1100

### Artikelnummer

43527601	RSS/EX-435	43527621	RSA/EX-435	43527631	P/EX-435	43527641	KZD/EX-435	43527651	ZPDO/EX-435	43527661	K/EX-435
43527602	RSS/EX-560	43527622	RSA/EX-560	43527632	P/EX-560	43527642	KZD/EX-560	43527652	ZPDO/EX-560	43527662	K/EX-560
43527603	RSS/EX-710	43527623	RSA/EX-710	43527633	P/EX-710	43527643	KZD/EX-710	43527653	ZPDO/EX-710	43527663	K/EX-710
43527604	RSS/EX-900	43527624	RSA/EX-900	43527634	P/EX-900	43527644	KZD/EX-900	43527654	ZPDO/EX-900	43527664	K/EX-900
43527605	RSS/EX-1100	43527625	RSA/EX-1100	43527635	P/EX-1100	43527645	KZD/EX-1100	43527655	ZPDO/EX-1100	43527665	K/EX-1100
43527611	RS/EX-435										
43527612	RS/EX-560										
43527613	RS/EX-710										
43527614	RS/EX-900										
43527615	RS/EX-1100										

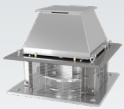

## ELEKTRISCHES ZUBEHÖR



Typ	inverter L	Umschalter PTC	Serviceschalter	Schütz
<b>2-POLIGE MOTOREN 3000RPM</b>				
REX-H/2-190-012T 2G	-	U-EK230	R-S 3-F + SP, 16A	DILM7-10(230V50HZ)
REX-H/2-190-012T 2G VFD	L 0,4 kW	U-EK230	R-S 3-F + SP, 16A	DILM7-10(230V50HZ)
REX-H/2-190-012T 2GD VFD	L 0,4 kW	U-EK230	R-S 3-F + SP, 16A	DILM7-10(230V50HZ)
REX-H/2-190-012S 2G	-	U-EK230	R-S 1-F + SP, 16A	DILM7-10(230V50HZ)
REX-H/2-190-012S 2GD	-	U-EK230	R-S 1-F + SP, 16A	DILM7-10(230V50HZ)
REX-H/2-220-012T 2G	-	U-EK230	R-S 3-F + SP, 16A	DILM7-10(230V50HZ)
REX-H/2-220-012T 2G VFD	L 0,4 kW	U-EK230	R-S 3-F + SP, 16A	DILM7-10(230V50HZ)
REX-H/2-220-012T 2GD VFD	L 0,4 kW	U-EK230	R-S 3-F + SP, 16A	DILM7-10(230V50HZ)
REX-H/2-220-012S 2G	-	U-EK230	R-S 1-F + SP, 16A	DILM7-10(230V50HZ)
REX-H/2-220-012S 2GD	-	U-EK230	R-S 1-F + SP, 16A	DILM7-10(230V50HZ)
REX-H/2-280(250)-025T 2G	-	U-EK230	R-S 3-F + SP, 16A	DILM7-10(230V50HZ)
REX-H/2-280(250)-025T 2G VFD	L 0,4 kW	U-EK230	R-S 3-F + SP, 16A	DILM7-10(230V50HZ)
REX-H/2-280(250)-025T 2GD VFD	L 0,4 kW	U-EK230	R-S 3-F + SP, 16A	DILM7-10(230V50HZ)
REX-H/2-280(250)-025S 2G	-	U-EK230	R-S 1-F + SP, 16A	DILM7-10(230V50HZ)
REX-H/2-280(250)-025S 2GD	-	U-EK230	R-S 1-F + SP, 16A	DILM7-10(230V50HZ)
<b>4-POLIGE MOTOREN 1500RPM</b>				
REX-H/4-190-006T 2G	-	U-EK230	R-S 3-F + SP, 16A	DILM7-10(230V50HZ)
REX-H/4-190-012T 2G VFD	L 0,4 kW	U-EK230	R-S 3-F + SP, 16A	DILM7-10(230V50HZ)
REX-H/4-190-012T 2GD VFD	L 0,4 kW	U-EK230	R-S 3-F + SP, 16A	DILM7-10(230V50HZ)
REX-H/4-190-009S 2G	-	U-EK230	R-S 1-F + SP, 16A	DILM7-10(230V50HZ)
REX-H/4-190-009S 2GD	-	U-EK230	R-S 1-F + SP, 16A	DILM7-10(230V50HZ)
REX-H/4-220-006T 2G	-	U-EK230	R-S 3-F + SP, 16A	DILM7-10(230V50HZ)
REX-H/4-220-012T 2G VFD	L 0,4 kW	U-EK230	R-S 3-F + SP, 16A	DILM7-10(230V50HZ)
REX-H/4-220-012T 2GD VFD	L 0,4 kW	U-EK230	R-S 3-F + SP, 16A	DILM7-10(230V50HZ)
REX-H/4-220-009S 2G	-	U-EK230	R-S 1-F + SP, 16A	DILM7-10(230V50HZ)
REX-H/4-220-009S 2GD	-	U-EK230	R-S 1-F + SP, 16A	DILM7-10(230V50HZ)
REX-H/4-250-018T 2G	-	U-EK230	R-S 3-F + SP, 16A	DILM7-10(230V50HZ)
REX-H/4-250-018T 2G VFD	L 0,4 kW	U-EK230	R-S 3-F + SP, 16A	DILM7-10(230V50HZ)
REX-H/4-250-018T 2GD VFD	L 0,4 kW	U-EK230	R-S 3-F + SP, 16A	DILM7-10(230V50HZ)
REX-H/4-250-018S 2G	-	U-EK230	R-S 1-F + SP, 16A	DILM7-10(230V50HZ)
REX-H/4-250-018S 2GD	-	U-EK230	R-S 1-F + SP, 16A	DILM7-10(230V50HZ)
REX-H/4-280-025T 2G	-	U-EK230	R-S 3-F + SP, 16A	DILM7-10(230V50HZ)
REX-H/4-280-025T 2G VFD	L 0,4 kW	U-EK230	R-S 3-F + SP, 16A	DILM7-10(230V50HZ)
REX-H/4-280-025T 2GD VFD	L 0,4 kW	U-EK230	R-S 3-F + SP, 16A	DILM7-10(230V50HZ)
REX-H/4-280-025S 2G	-	U-EK230	R-S 1-F + SP, 16A	DILM7-10(230V50HZ)
REX-H/4-280-025S 2GD	-	U-EK230	R-S 1-F + SP, 16A	DILM7-10(230V50HZ)
REX-H/4-315-037T 2G	-	U-EK230	R-S 3-F + SP, 16A	DILM7-10(230V50HZ)
REX-H/4-315-037T 2G VFD	L 0,4 kW	U-EK230	R-S 3-F + SP, 16A	DILM7-10(230V50HZ)
REX-H/4-315-037T 2GD VFD	L 0,4 kW	U-EK230	R-S 3-F + SP, 16A	DILM7-10(230V50HZ)
REX-H/4-315-037S 2G	-	U-EK230	R-S 1-F + SP, 16A	DILM7-10(230V50HZ)
REX-H/4-315-037S 2GD	-	U-EK230	R-S 1-F + SP, 16A	DILM7-10(230V50HZ)
REX-H/4-355-055T 2G	-	U-EK230	R-S 3-F + SP, 16A	DILM7-10(230V50HZ)
REX-H/4-355-055T 2G VFD	L 0,75 kW	U-EK230	R-S 3-F + SP, 16A	DILM7-10(230V50HZ)
REX-H/4-355-055T 2GD VFD	L 0,75 kW	U-EK230	R-S 3-F + SP, 16A	DILM7-10(230V50HZ)
REX-H/4-355-055S 2G	-	U-EK230	R-S 1-F + SP, 16A	DILM7-10(230V50HZ)
REX-H/4-355-055S 2GD	-	U-EK230	R-S 1-F + SP, 16A	DILM7-10(230V50HZ)
REX-H/4-400-075T 2G	-	U-EK230	R-S 3-F + SP, 16A	DILM7-10(230V50HZ)
REX-H/4-400-075T 2G VFD	L 0,75 kW	U-EK230	R-S 3-F + SP, 16A	DILM7-10(230V50HZ)
REX-H/4-400-075T 2GD VFD	L 0,75 kW	U-EK230	R-S 3-F + SP, 16A	DILM7-10(230V50HZ)

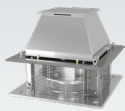

## ELEKTRISCHES ZUBEHÖR



Typ	inverter L	Umschalter PTC	Serviceschalter	Schütz
REX-H/4-400-075S 2G	-	U-EK230	R-S 1-F + SP, 16A	DILM7-10(230V50HZ)
REX-H/4-400-075S 2GD	-	U-EK230	R-S 1-F + SP, 16A	DILM7-10(230V50HZ)
REX-H/4-450-110T 2G	-	U-EK230	R-S 3-F + SP, 16A	DILM7-10(230V50HZ)
REX-H/4-450-110T 2G VFD	L 1,5 kW	U-EK230	R-S 3-F + SP, 16A	DILM7-10(230V50HZ)
REX-H/4-450-110T 2GD VFD	L 1,5 kW	U-EK230	R-S 3-F + SP, 16A	DILM7-10(230V50HZ)
REX-H/4-450-110S 2G	-	U-EK230	R-S 1-F + SP, 16A	DILM7-10(230V50HZ)
REX-H/4-450-110S 2GD	-	U-EK230	R-S 1-F + SP, 16A	DILM7-10(230V50HZ)
REX-H/4-500-220T 2G	-	U-EK230	R-S 3-F + SP, 16A	DILM7-10(230V50HZ)
REX-H/4-500-220T 2G VFD	L 2,2 kW	U-EK230	R-S 3-F + SP, 16A	DILM7-10(230V50HZ)
REX-H/4-500-220T 2GD VFD	L 2,2 kW	U-EK230	R-S 3-F + SP, 16A	DILM7-10(230V50HZ)
REX-H/4-560-300T 2G	-	U-EK230	R-S 3-F + SP, 16A	DILM7-10(230V50HZ)
REX-H/4-560-300T 2G VFD	L 3 kW	U-EK230	R-S 3-F + SP, 16A	DILM7-10(230V50HZ)
REX-H/4-560-300T 2GD VFD	L 3 kW	U-EK230	R-S 3-F + SP, 16A	DILM7-10(230V50HZ)
<b>6-POLIGE MOTOREN 1000RPM</b>				
REX-H/6-250-018T 2G	-	U-EK230	R-S 3-F + SP, 16A	DILM7-10(230V50HZ)
REX-H/6-250-012T 2G VFD	L 0,4 kW	U-EK230	R-S 3-F + SP, 16A	DILM7-10(230V50HZ)
REX-H/6-250-012T 2GD VFD	L 0,4 kW	U-EK230	R-S 3-F + SP, 16A	DILM7-10(230V50HZ)
REX-H/6-280-018T 2G	-	U-EK230	R-S 3-F + SP, 16A	DILM7-10(230V50HZ)
REX-H/6-280-012T 2G VFD	L 0,4 kW	U-EK230	R-S 3-F + SP, 16A	DILM7-10(230V50HZ)
REX-H/6-280-012T 2GD VFD	L 0,4 kW	U-EK230	R-S 3-F + SP, 16A	DILM7-10(230V50HZ)
REX-H/6-315-018T 2G	-	U-EK230	R-S 3-F + SP, 16A	DILM7-10(230V50HZ)
REX-H/6-315-012T 2G VFD	L 0,4 kW	U-EK230	R-S 3-F + SP, 16A	DILM7-10(230V50HZ)
REX-H/6-315-012T 2GD VFD	L 0,4 kW	U-EK230	R-S 3-F + SP, 16A	DILM7-10(230V50HZ)
REX-H/6-355-018T 2G	-	U-EK230	R-S 3-F + SP, 16A	DILM7-10(230V50HZ)
REX-H/6-355-018T 2G VFD	L 0,4 kW	U-EK230	R-S 3-F + SP, 16A	DILM7-10(230V50HZ)
REX-H/6-355-018T 2GD VFD	L 0,4 kW	U-EK230	R-S 3-F + SP, 16A	DILM7-10(230V50HZ)
REX-H/6-400-025T 2G	-	U-EK230	R-S 3-F + SP, 16A	DILM7-10(230V50HZ)
REX-H/6-400-025T 2G VFD	L 0,4 kW	U-EK230	R-S 3-F + SP, 16A	DILM7-10(230V50HZ)
REX-H/6-400-025T 2GD VFD	L 0,4 kW	U-EK230	R-S 3-F + SP, 16A	DILM7-10(230V50HZ)
REX-H/6-450-037T 2G	-	U-EK230	R-S 3-F + SP, 16A	DILM7-10(230V50HZ)
REX-H/6-450-037T 2G VFD	L 0,4 kW	U-EK230	R-S 3-F + SP, 16A	DILM7-10(230V50HZ)
REX-H/6-450-037T 2GD VFD	L 0,4 kW	U-EK230	R-S 3-F + SP, 16A	DILM7-10(230V50HZ)
REX-H/6-500-075T 2G	-	U-EK230	R-S 3-F + SP, 16A	DILM7-10(230V50HZ)
REX-H/6-500-075T 2G VFD	L 0,75 kW	U-EK230	R-S 3-F + SP, 16A	DILM7-10(230V50HZ)
REX-H/6-500-075T 2GD VFD	L 0,75 kW	U-EK230	R-S 3-F + SP, 16A	DILM7-10(230V50HZ)
REX-H/6-560-110T 2G	-	U-EK230	R-S 3-F + SP, 16A	DILM7-10(230V50HZ)
REX-H/6-560-110T 2G VFD	L 1,5 kW	U-EK230	R-S 3-F + SP, 16A	DILM7-10(230V50HZ)
REX-H/6-560-110T 2GD VFD	L 1,5 kW	U-EK230	R-S 3-F + SP, 16A	DILM7-10(230V50HZ)
REX-H/6-630-220T 2G	-	U-EK230	R-S 3-F + SP, 16A	DILM7-10(230V50HZ)
REX-H/6-630-220T 2G VFD	L 2,2 kW	U-EK230	R-S 3-F + SP, 16A	DILM7-10(230V50HZ)
REX-H/6-630-220T 2GD VFD	L 2,2 kW	U-EK230	R-S 3-F + SP, 16A	DILM7-10(230V50HZ)
REX-H/6-710-300T 2G	-	U-EK230	R-S 3-F + SP, 16A	DILM7-10(230V50HZ)
REX-H/6-710-300T 2G VFD	L 4,0 kW	U-EK230	R-S 3-F + SP, 16A	DILM7-10(230V50HZ)
REX-H/6-710-300T 2GD VFD	L 4,0 kW	U-EK230	R-S 3-F + SP, 16A	DILM7-10(230V50HZ)
REX-H/6-800-550T 2G	-	U-EK230	R-S 3-F + SP, 25A/6	DILM12-10(230V50HZ)
REX-H/6-800-550T 2G VFD	L 5,5 kW	U-EK230	R-S 3-F + SP, 25A	DILM12-10(230V50HZ)
REX-H/6-800-550T 2GD VFD	L 5,5 kW	U-EK230	R-S 3-F + SP, 25A	DILM12-10(230V50HZ)

\* Geräte für den sicheren Bereich, die Ausführung für den ATEX-Bereich sollte mit der technischen Abteilung von Ventur Deutschland GmbH