

Application

Extraction roof fans REX-H comply with the requirements of ATEX Directive 2014/34/UE, are designed for use in hazard zones excluding mines and mining pits, meets the requirements of group II category 2G/3G - zone 1 and/or 2 and category 2D/3D - zone 21 and/or 22.

ATEX marking:

- II 2G Ex h IIB+H2 T3 Gb
- II 2G Ex h IIB+H2 T4 Gb
- II 2D Ex h IIIC T125°C Db

Construction

- medium- pressure centrifugal fan with direct drive
- aluminium sheet impeller with forward curved blades, dynamically balanced according to ISO 1940-1,
- casing parts made of unpainted aluminium and stainless steel sheet,
- temperature of the transported medium is the same as the ambient temperature of the device (see technical data),
- minimum ambient temperature is -20°C,
- suitable for mounting a vibration sensor.

Electric motor

- asynchronous, single-phase, 230V, 50Hz,
- asynchronous, three-phase, 230/400V 50Hz or 400/690V 50Hz (depending on the model),
- insulation class F,
- thermal protection PTC,
- VFD models suitable for frequency regulation.

Special execution

- painted casing,
- different motor voltage and frequency,
- different motor degree of protection,
- impeller and casing made of stainless steel sheet,
- ambient temperature up to +60°C.

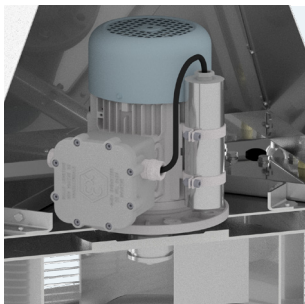
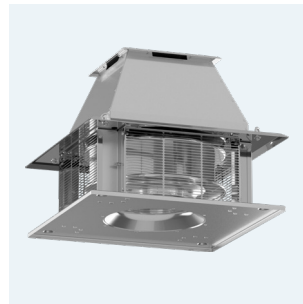
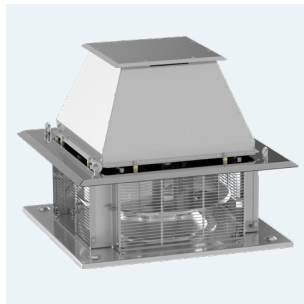
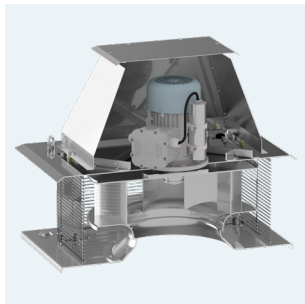

RELATED PRODUCTS



REX-V
Roof fan
with vertical
discharge



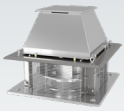

NOMINAL DATA

type	airflow max	pressure max	speed	voltage rated	current max abs.**	power motor	sound pressure level*	temp. operating min / max	temp. ambient min / max	weight	article number
2-POLE MOTORS 3000RPM											
REX-H/2-190-012T 2G	750 m ³ /h	350 Pa	2 750 rpm	400 V	0,4 A	120 W	68 dB(A)	-20 / 60 °C	-20 / 40 °C	12,0 kg	45527200
REX-H/2-190-012T 2G VFD	750 m ³ /h	350 Pa	2 800 rpm	400 V	0,48 A	120 W	68 dB(A)	-20 / 60 °C	-20 / 50 °C	14,0 kg	425527201
REX-H/2-190-012T 2GD VFD	750 m ³ /h	350 Pa	2 800 rpm	400 V	0,48 A	120 W	68 dB(A)	-20 / 60 °C	-20 / 50 °C	14,0 kg	425527202
REX-H/2-190-012S 2G	750 m ³ /h	350 Pa	2 880 rpm	230 V	1,3 A	120 W	68 dB(A)	-20 / 60 °C	-20 / 50 °C	15,0 kg	45527203
REX-H/2-190-012S 2GD	750 m ³ /h	350 Pa	2 880 rpm	230 V	1,3 A	120 W	68 dB(A)	-20 / 60 °C	-20 / 50 °C	15,0 kg	45527204
REX-H/2-220-012T 2G	1050 m ³ /h	450 Pa	2 750 rpm	400 V	0,4 A	120 W	69 dB(A)	-20 / 60 °C	-20 / 40 °C	12,0 kg	45527210
REX-H/2-220-012T 2G VFD	1050 m ³ /h	450 Pa	2 800 rpm	400 V	0,48 A	120 W	69 dB(A)	-20 / 60 °C	-20 / 50 °C	14,0 kg	425527211
REX-H/2-220-012T 2GD VFD	1050 m ³ /h	450 Pa	2 800 rpm	400 V	0,48 A	120 W	69 dB(A)	-20 / 60 °C	-20 / 50 °C	14,0 kg	425527212
REX-H/2-220-012S 2G	1050 m ³ /h	450 Pa	2 880 rpm	230 V	1,3 A	120 W	69 dB(A)	-20 / 60 °C	-20 / 50 °C	15,0 kg	45527213
REX-H/2-220-012S 2GD	1050 m ³ /h	450 Pa	2 880 rpm	230 V	1,3 A	120 W	69 dB(A)	-20 / 60 °C	-20 / 50 °C	15,0 kg	45527214
REX-H/2-280(250)-025T 2G	1800 m ³ /h	650 Pa	2 870 rpm	400 V	0,9 A	250 W	72 dB(A)	-20 / 60 °C	-20 / 40 °C	15,0 kg	45527220
REX-H/2-280(250)-025T 2G VFD	1800 m ³ /h	650 Pa	2 830 rpm	400 V	0,81 A	250 W	72 dB(A)	-20 / 60 °C	-20 / 50 °C	17,0 kg	425527221
REX-H/2-280(250)-025T 2GD VFD	1800 m ³ /h	650 Pa	2 830 rpm	400 V	0,81 A	250 W	72 dB(A)	-20 / 60 °C	-20 / 50 °C	17,0 kg	425527222
REX-H/2-280(250)-025S 2G	1800 m ³ /h	650 Pa	2 800 rpm	230 V	1,81 A	250 W	72 dB(A)	-20 / 60 °C	-20 / 50 °C	17,0 kg	45527223
REX-H/2-280(250)-025S 2GD	1800 m ³ /h	650 Pa	2 800 rpm	230 V	1,81 A	250 W	72 dB(A)	-20 / 60 °C	-20 / 50 °C	17,0 kg	45527224
4-POLE MOTORS 1500RPM											
REX-H/4-190-006T 2G	370 m ³ /h	85 Pa	1380 rpm	400 V	0,31 A	60 W	53 dB(A)	-20 / 60 °C	-20 / 40 °C	12,0 kg	45527400
REX-H/4-190-012T 2G VFD	370 m ³ /h	85 Pa	1390 rpm	400 V	0,49 A	120 W	53 dB(A)	-20 / 60 °C	-20 / 50 °C	14,5 kg	425527401
REX-H/4-190-012T 2GD VFD	370 m ³ /h	85 Pa	1390 rpm	400 V	0,49 A	120 W	53 dB(A)	-20 / 60 °C	-20 / 50 °C	14,5 kg	425527402
REX-H/4-190-009S 2G	370 m ³ /h	85 Pa	1420 rpm	230 V	0,8 A	90 W	53 dB(A)	-20 / 60 °C	-20 / 50 °C	15,0 kg	45527403
REX-H/4-190-009S 2GD	370 m ³ /h	85 Pa	1420 rpm	230 V	0,8 A	90 W	53 dB(A)	-20 / 60 °C	-20 / 50 °C	15,0 kg	45527404
REX-H/4-220-006T 2G	515 m ³ /h	110 Pa	1380 rpm	400 V	0,31 A	60 W	54 dB(A)	-20 / 60 °C	-20 / 40 °C	12,0 kg	45527410
REX-H/4-220-012T 2G VFD	515 m ³ /h	110 Pa	1390 rpm	400 V	0,49 A	120 W	54 dB(A)	-20 / 60 °C	-20 / 50 °C	14,5 kg	425527411
REX-H/4-220-012T 2GD VFD	515 m ³ /h	110 Pa	1390 rpm	400 V	0,49 A	120 W	54 dB(A)	-20 / 60 °C	-20 / 50 °C	14,5 kg	425527412
REX-H/4-220-009S 2G	515 m ³ /h	110 Pa	1420 rpm	230 V	0,8 A	90 W	54 dB(A)	-20 / 60 °C	-20 / 50 °C	15,0 kg	45527413
REX-H/4-220-009S 2GD	515 m ³ /h	110 Pa	1420 rpm	230 V	0,8 A	90 W	54 dB(A)	-20 / 60 °C	-20 / 50 °C	15,0 kg	45527414
REX-H/4-250-018T 2G	1140 m ³ /h	185 Pa	1390 rpm	400 V	0,7 A	180 W	54 dB(A)	-20 / 60 °C	-20 / 40 °C	16,0 kg	45527420
REX-H/4-250-018T 2G VFD	1140 m ³ /h	185 Pa	1340 rpm	400 V	0,57 A	180 W	54 dB(A)	-20 / 60 °C	-20 / 50 °C	17,0 kg	425527421
REX-H/4-250-018T 2GD VFD	1140 m ³ /h	185 Pa	1340 rpm	400 V	0,57 A	180 W	54 dB(A)	-20 / 60 °C	-20 / 50 °C	17,0 kg	425527422
REX-H/4-250-018S 2G	1140 m ³ /h	185 Pa	1355 rpm	230 V	1,38 A	180 W	54 dB(A)	-20 / 60 °C	-20 / 50 °C	18,0 kg	45527423
REX-H/4-250-018S 2GD	1140 m ³ /h	185 Pa	1355 rpm	230 V	1,38 A	180 W	54 dB(A)	-20 / 60 °C	-20 / 50 °C	18,0 kg	45527424
REX-H/4-280-025T 2G	1615 m ³ /h	235 Pa	1370 rpm	400 V	0,85 A	250 W	57 dB(A)	-20 / 60 °C	-20 / 40 °C	17,0 kg	45527430
REX-H/4-280-025T 2G VFD	1615 m ³ /h	235 Pa	1430 rpm	400 V	0,79 A	250 W	57 dB(A)	-20 / 60 °C	-20 / 50 °C	19,0 kg	425527431
REX-H/4-280-025T 2GD VFD	1615 m ³ /h	235 Pa	1430 rpm	400 V	0,79 A	250 W	57 dB(A)	-20 / 60 °C	-20 / 50 °C	19,0 kg	425527432
REX-H/4-280-025S 2G	1615 m ³ /h	235 Pa	1450 rpm	230 V	2 A	250 W	57 dB(A)	-20 / 60 °C	-20 / 50 °C	20,0 kg	45527433
REX-H/4-280-025S 2GD	1615 m ³ /h	235 Pa	1450 rpm	230 V	2 A	250 W	57 dB(A)	-20 / 60 °C	-20 / 50 °C	20,0 kg	45527434
REX-H/4-315-037T 2G	2 280 m ³ /h	300 Pa	1350 rpm	400 V	1,15 A	370 W	60 dB(A)	-20 / 60 °C	-20 / 40 °C	23,0 kg	45527440
REX-H/4-315-037T 2G VFD	2 280 m ³ /h	300 Pa	1420 rpm	400 V	1,08 A	370 W	60 dB(A)	-20 / 60 °C	-20 / 50 °C	24,0 kg	425527441
REX-H/4-315-037T 2GD VFD	2 280 m ³ /h	300 Pa	1420 rpm	400 V	1,08 A	370 W	60 dB(A)	-20 / 60 °C	-20 / 50 °C	23,0 kg	425527442
REX-H/4-315-037S 2G	2 280 m ³ /h	300 Pa	1430 rpm	230 V	2,55 A	370 W	60 dB(A)	-20 / 60 °C	-20 / 50 °C	25,5 kg	45527443
REX-H/4-315-037S 2GD	2 280 m ³ /h	300 Pa	1430 rpm	230 V	2,55 A	370 W	60 dB(A)	-20 / 60 °C	-20 / 50 °C	25,5 kg	45527444
REX-H/4-355-055T 2G	3 230 m ³ /h	385 Pa	1360 rpm	400 V	1,5 A	550 W	63 dB(A)	-20 / 60 °C	-20 / 40 °C	30,5 kg	45527450
REX-H/4-355-055T 2G VFD	3 230 m ³ /h	385 Pa	1440 rpm	400 V	1,32 A	550 W	63 dB(A)	-20 / 60 °C	-20 / 50 °C	33,0 kg	425527451
REX-H/4-355-055T 2GD VFD	3 230 m ³ /h	385 Pa	1440 rpm	400 V	1,32 A	550 W	63 dB(A)	-20 / 60 °C	-20 / 50 °C	33,0 kg	425527452

* Measurement made at a distance of 1.5m from the outlet, for Q = 2/3 * Qmax
 ** the value of the rated current may vary depending on the manufacturer of the electric motor used.

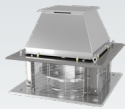

NOMINAL DATA

type	airflow max	pressure max	speed	voltage rated	current max abs.**	power motor	sound pressure level*	temp. operating min / max	temp. ambient min / max	weight	article number
REX-H/4-355-055S 2G	3 230 m³/h	385 Pa	1 440 rpm	230 V	3,7 A	550 W	63 dB(A)	-20 / 60 °C	-20 / 50 °C	33,0 kg	45527453
REX-H/4-355-055S 2GD	3 230 m³/h	385 Pa	1 440 rpm	230 V	3,7 A	550 W	63 dB(A)	-20 / 60 °C	-20 / 50 °C	33,0 kg	45527454
REX-H/4-400-075T 2G	4 750 m³/h	490 Pa	1 360 rpm	400 V	1,9 A	750 W	66 dB(A)	-20 / 60 °C	-20 / 40 °C	38,0 kg	45527460
REX-H/4-400-075T 2G VFD	4 750 m³/h	490 Pa	1 445 rpm	400 V	1,85 A	750 W	66 dB(A)	-20 / 60 °C	-20 / 50 °C	42,0 kg	435527461
REX-H/4-400-075T 2GD VFD	4 750 m³/h	490 Pa	1 445 rpm	400 V	1,85 A	750 W	66 dB(A)	-20 / 60 °C	-20 / 50 °C	42,0 kg	435527462
REX-H/4-400-075S 2G	4 750 m³/h	490 Pa	1 410 rpm	230 V	4,74 A	750 W	66 dB(A)	-20 / 60 °C	-20 / 50 °C	41,0 kg	45527463
REX-H/4-400-075S 2GD	4 750 m³/h	490 Pa	1 410 rpm	230 V	4,74 A	750 W	66 dB(A)	-20 / 60 °C	-20 / 50 °C	41,0 kg	45527464
REX-H/4-450-110T 2G	6 745 m³/h	640 Pa	1 405 rpm	400 V	2,7 A	1100 W	69 dB(A)	-20 / 60 °C	-20 / 40 °C	49,0 kg	45527470
REX-H/4-450-110T 2G VFD	6 745 m³/h	640 Pa	1 440 rpm	400 V	2,61 A	1100 W	69 dB(A)	-20 / 60 °C	-20 / 50 °C	52,0 kg	435527471
REX-H/4-450-110T 2GD VFD	6 745 m³/h	640 Pa	1 440 rpm	400 V	2,61 A	1100 W	69 dB(A)	-20 / 60 °C	-20 / 50 °C	52,0 kg	435527472
REX-H/4-450-110S 2G	6 745 m³/h	640 Pa	1 440 rpm	230 V	7,6 A	1100 W	69 dB(A)	-20 / 60 °C	-20 / 50 °C	51,0 kg	45527473
REX-H/4-450-110S 2GD	6 745 m³/h	640 Pa	1 440 rpm	230 V	7,6 A	1100 W	69 dB(A)	-20 / 60 °C	-20 / 50 °C	51,0 kg	45527474
REX-H/4-500-220T 2G	9 215 m³/h	765 Pa	1 425 rpm	400 V	5,2 A	2200 W	72 dB(A)	-20 / 60 °C	-20 / 40 °C	64,5 kg	45527480
REX-H/4-500-220T 2G VFD	9 215 m³/h	765 Pa	1 440 rpm	400 V	4,9 A	2200 W	72 dB(A)	-20 / 60 °C	-20 / 50 °C	68,5 kg	435527481
REX-H/4-500-220T 2GD VFD	9 215 m³/h	765 Pa	1 440 rpm	400 V	4,9 A	2200 W	72 dB(A)	-20 / 60 °C	-20 / 50 °C	68,5 kg	435527482
REX-H/4-560-300T 2G	12 900 m³/h	950 Pa	1 415 rpm	400 V	6,9 A	3000 W	76 dB(A)	-20 / 60 °C	-20 / 40 °C	74,0 kg	45527490
REX-H/4-560-300T 2G VFD	12 900 m³/h	950 Pa	1 455 rpm	400 V	6,05 A	3000 W	76 dB(A)	-20 / 60 °C	-20 / 50 °C	84,0 kg	435527491
REX-H/4-560-300T 2GD VFD	12 900 m³/h	950 Pa	1 455 rpm	400 V	6,05 A	3000 W	76 dB(A)	-20 / 60 °C	-20 / 50 °C	84,0 kg	435527492

6-POLE MOTORS 1000RPM

REX-H/6-250-018T 2G	750 m³/h	80 Pa	880 rpm	400 V	0,7 A	180 W	51 dB(A)	-20 / 60 °C	-20 / 40 °C	16,5 kg	45527620
REX-H/6-250-012T 2G VFD	750 m³/h	80 Pa	935 rpm	400 V	0,59 A	120 W	51 dB(A)	-20 / 60 °C	-20 / 50 °C	18,0 kg	425527621
REX-H/6-250-012T 2GD VFD	750 m³/h	80 Pa	935 rpm	400 V	0,59 A	120 W	51 dB(A)	-20 / 60 °C	-20 / 50 °C	18,0 kg	425527622
REX-H/6-280-018T 2G	1 060 m³/h	100 Pa	880 rpm	400 V	0,7 A	180 W	54 dB(A)	-20 / 60 °C	-20 / 40 °C	17,0 kg	45527630
REX-H/6-280-012T 2G VFD	1 060 m³/h	100 Pa	935 rpm	400 V	0,59 A	120 W	54 dB(A)	-20 / 60 °C	-20 / 50 °C	18,0 kg	425527631
REX-H/6-280-012T 2GD VFD	1 060 m³/h	100 Pa	935 rpm	400 V	0,59 A	120 W	54 dB(A)	-20 / 60 °C	-20 / 50 °C	18,0 kg	425527632
REX-H/6-315-018T 2G	1 500 m³/h	130 Pa	880 rpm	400 V	0,7 A	180 W	57 dB(A)	-20 / 60 °C	-20 / 40 °C	22,0 kg	45527640
REX-H/6-315-012T 2G VFD	1 500 m³/h	130 Pa	935 rpm	400 V	0,59 A	120 W	57 dB(A)	-20 / 60 °C	-20 / 50 °C	23,0 kg	425527641
REX-H/6-315-012T 2GD VFD	1 500 m³/h	130 Pa	935 rpm	400 V	0,59 A	120 W	57 dB(A)	-20 / 60 °C	-20 / 50 °C	23,0 kg	425527642
REX-H/6-355-018T 2G	2 115 m³/h	165 Pa	880 rpm	400 V	0,7 A	180 W	60 dB(A)	-20 / 60 °C	-20 / 40 °C	28,0 kg	45527650
REX-H/6-355-018T 2G VFD	2 115 m³/h	165 Pa	925 rpm	400 V	0,82 A	180 W	60 dB(A)	-20 / 60 °C	-20 / 50 °C	30,0 kg	425527651
REX-H/6-355-018T 2GD VFD	2 115 m³/h	165 Pa	925 rpm	400 V	0,82 A	180 W	60 dB(A)	-20 / 60 °C	-20 / 50 °C	30,0 kg	425527652
REX-H/6-400-025T 2G	3 110 m³/h	210 Pa	900 rpm	400 V	0,85 A	250 W	63 dB(A)	-20 / 60 °C	-20 / 40 °C	35,0 kg	45527660
REX-H/6-400-025T 2G VFD	3 110 m³/h	210 Pa	930 rpm	400 V	0,88 A	250 W	63 dB(A)	-20 / 60 °C	-20 / 50 °C	37,0 kg	425527661
REX-H/6-400-025T 2GD VFD	3 110 m³/h	210 Pa	930 rpm	400 V	0,88 A	250 W	63 dB(A)	-20 / 60 °C	-20 / 50 °C	37,0 kg	425527662
REX-H/6-450-037T 2G	4 420 m³/h	275 Pa	920 rpm	400 V	1,3 A	370 W	66 dB(A)	-20 / 60 °C	-20 / 40 °C	44,0 kg	45527670
REX-H/6-450-037T 2G VFD	4 420 m³/h	275 Pa	945 rpm	400 V	1,05 A	370 W	66 dB(A)	-20 / 60 °C	-20 / 50 °C	47,0 kg	425527671
REX-H/6-450-037T 2GD VFD	4 420 m³/h	275 Pa	945 rpm	400 V	1,05 A	370 W	66 dB(A)	-20 / 60 °C	-20 / 50 °C	47,0 kg	425527672
REX-H/6-500-075T 2G	6 030 m³/h	330 Pa	915 rpm	400 V	2,1 A	750 W	69 dB(A)	-20 / 60 °C	-20 / 40 °C	60,0 kg	45527680
REX-H/6-500-075T 2G VFD	6 030 m³/h	330 Pa	945 rpm	400 V	1,96 A	750 W	69 dB(A)	-20 / 60 °C	-20 / 50 °C	60,0 kg	435527681
REX-H/6-500-075T 2GD VFD	6 030 m³/h	330 Pa	945 rpm	400 V	1,96 A	750 W	69 dB(A)	-20 / 60 °C	-20 / 50 °C	60,0 kg	435527682
REX-H/6-560-110T 2G	8 465 m³/h	410 Pa	920 rpm	400 V	3 A	1100 W	73 dB(A)	-20 / 60 °C	-20 / 40 °C	65,5 kg	45527690
REX-H/6-560-110T 2G VFD	8 465 m³/h	410 Pa	950 rpm	400 V	2,7 A	1100 W	73 dB(A)	-20 / 60 °C	-20 / 50 °C	72,0 kg	435527691
REX-H/6-560-110T 2GD VFD	8 465 m³/h	410 Pa	950 rpm	400 V	2,7 A	1100 W	73 dB(A)	-20 / 60 °C	-20 / 50 °C	72,0 kg	435527692
REX-H/6-630-220T 2G	12 250 m³/h	535 Pa	960 rpm	400 V	5,1 A	2200 W	77 dB(A)	-20 / 60 °C	-20 / 40 °C	111,0 kg	45527700
REX-H/6-630-220T 2G VFD	12 250 m³/h	535 Pa	955 rpm	400 V	5,2 A	2200 W	77 dB(A)	-20 / 60 °C	-20 / 50 °C	122,0 kg	435527701
REX-H/6-630-220T 2GD VFD	12 250 m³/h	535 Pa	955 rpm	400 V	5,2 A	2200 W	77 dB(A)	-20 / 60 °C	-20 / 50 °C	122,0 kg	435527702

* Measurement made at a distance of 1.5m from the outlet, for Q = 2/3 * Qmax

** the value of the rated current may vary depending on the manufacturer of the electric motor used.

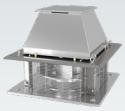

NOMINAL DATA

type	airflow max	pressure max	speed	voltage rated	current max abs.**	power motor	sound pressure level*	temp. operating min / max	temp. ambient min / max	weight	article number
REX-H/6-710-300T 2G	17 480 m ³ /h	680 Pa	950 rpm	400 V	6,8 A	3000 W	81 dB(A)	-20 / 60 °C	-20 / 40 °C	152,0 kg	45527710
REX-H/6-710-300T 2G VFD	17 480 m ³ /h	680 Pa	965 rpm	400 V	6,32 A	3000 W	81 dB(A)	-20 / 60 °C	-20 / 50 °C	147,0 kg	435527711
REX-H/6-710-300T 2GD VFD	17 480 m ³ /h	680 Pa	965 rpm	400 V	6,32 A	3000 W	81 dB(A)	-20 / 60 °C	-20 / 50 °C	147,0 kg	435527712
REX-H/6-800-550T 2G	26000 m ³ /h	900 Pa	950 rpm	400 V	11,6 A	5500 W	85 dB(A)	-20 / 60 °C	-20 / 40 °C	210,0 kg	45527720
REX-H/6-800-550T 2G VFD	26000 m ³ /h	900 Pa	970 rpm	400 V	11,4 A	5500 W	85 dB(A)	-20 / 60 °C	-20 / 50 °C	242,0 kg	435527721
REX-H/6-800-550T 2GD VFD	26000 m ³ /h	900 Pa	970 rpm	400 V	11,4 A	5500 W	85 dB(A)	-20 / 60 °C	-20 / 50 °C	242,0 kg	435527722

* Measurement made at a distance of 1.5m from the outlet, for Q = 2/3 * Qmax

** the value of the rated current may vary depending on the manufacturer of the electric motor used.

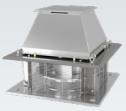

PERFORMANCE CHARACTERISTICS OF THE FANS - 2-POLE MOTORS 3000RPM

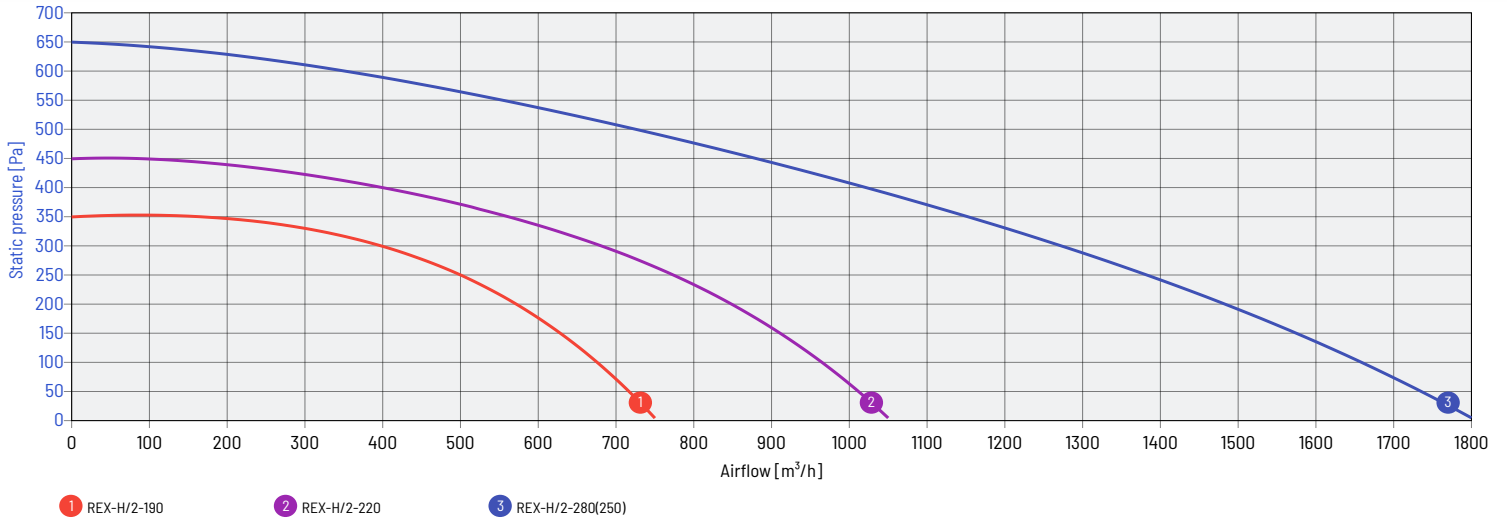

PERFORMANCE CHARACTERISTICS OF THE FANS - 4-POLE MOTORS 1500RPM

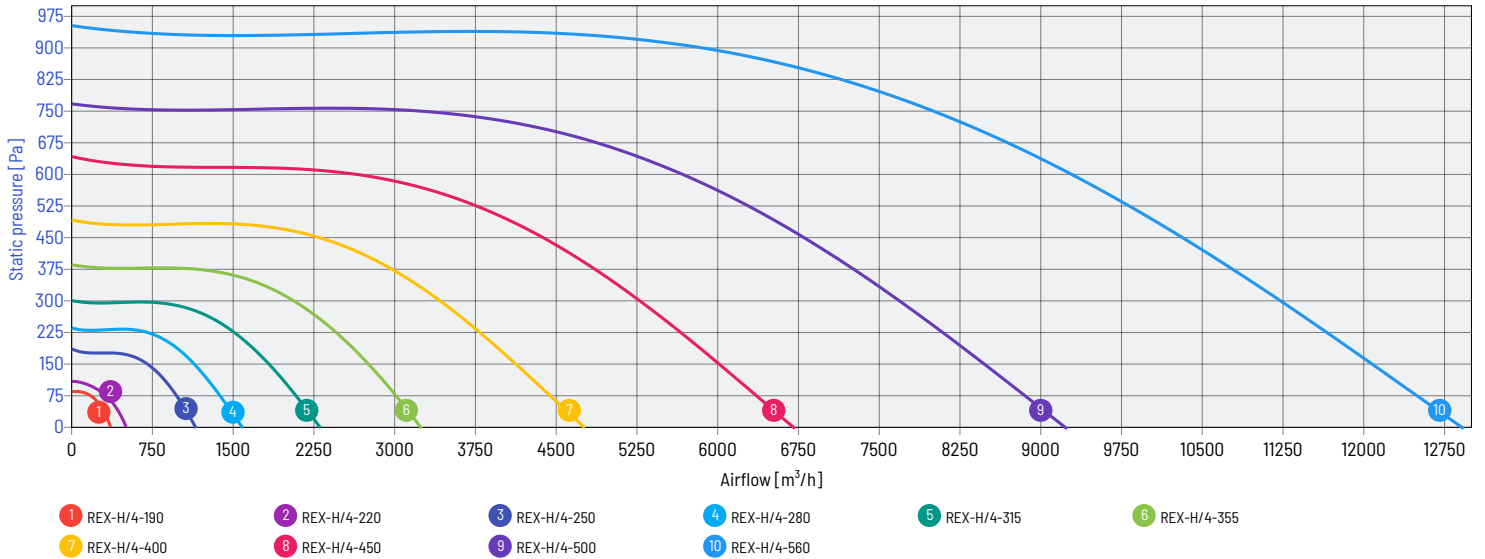

PERFORMANCE CHARACTERISTICS OF THE FANS - 6-POLE MOTORS 1000RPM

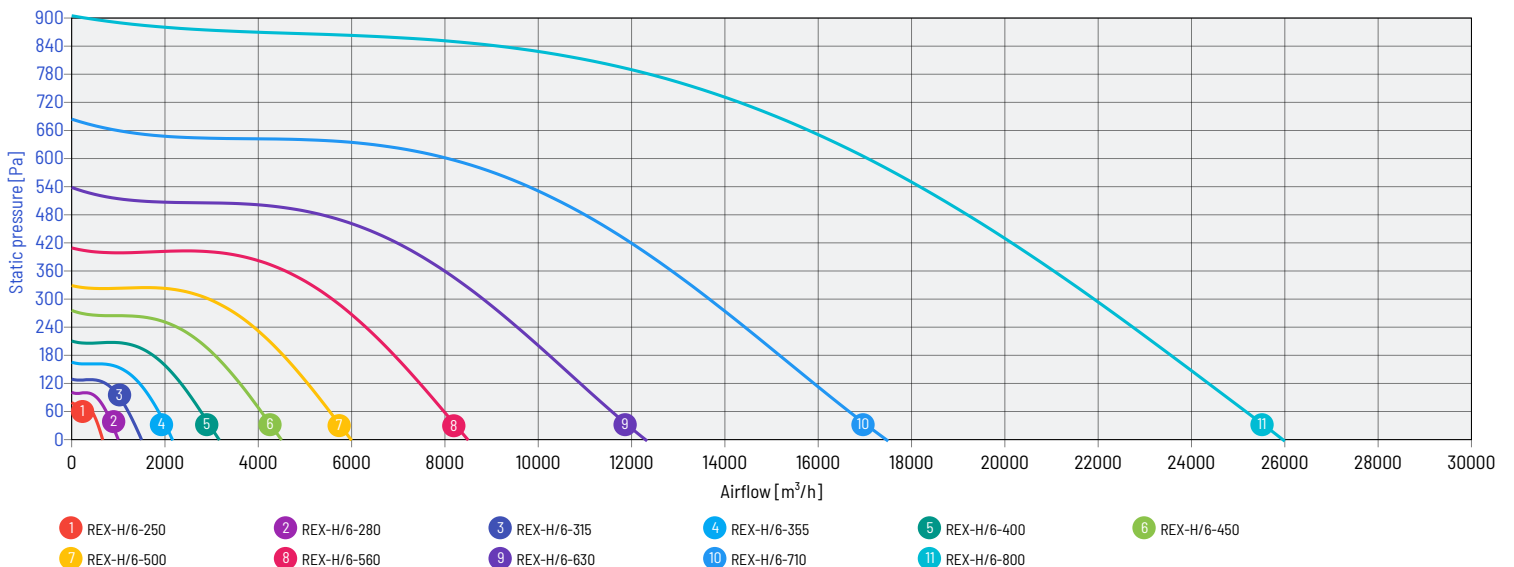

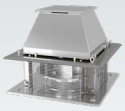

PERFORMANCE CHARACTERISTICS OF THE FANS

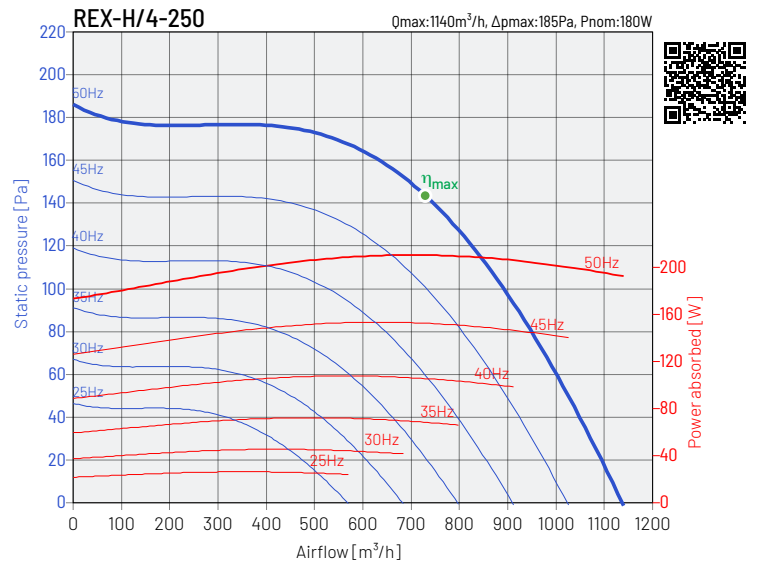
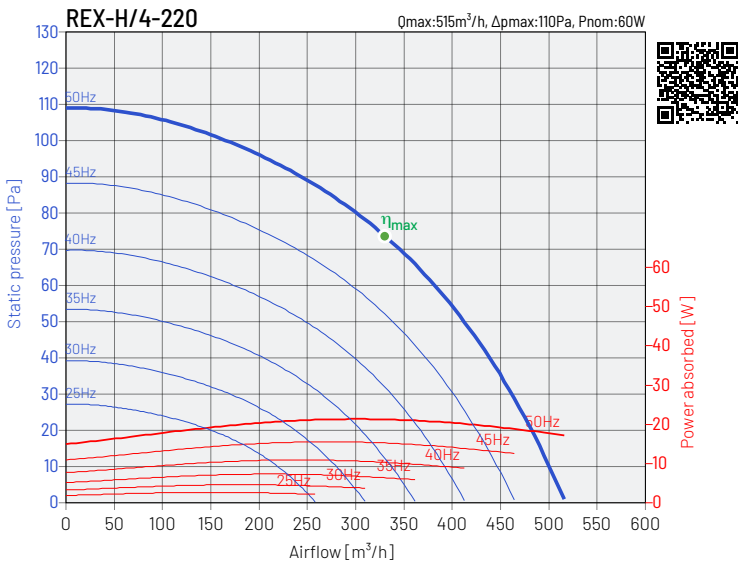
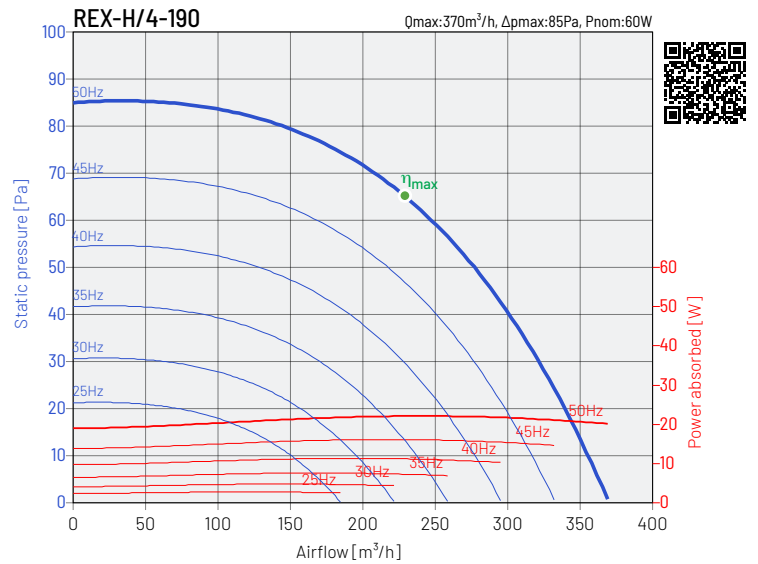
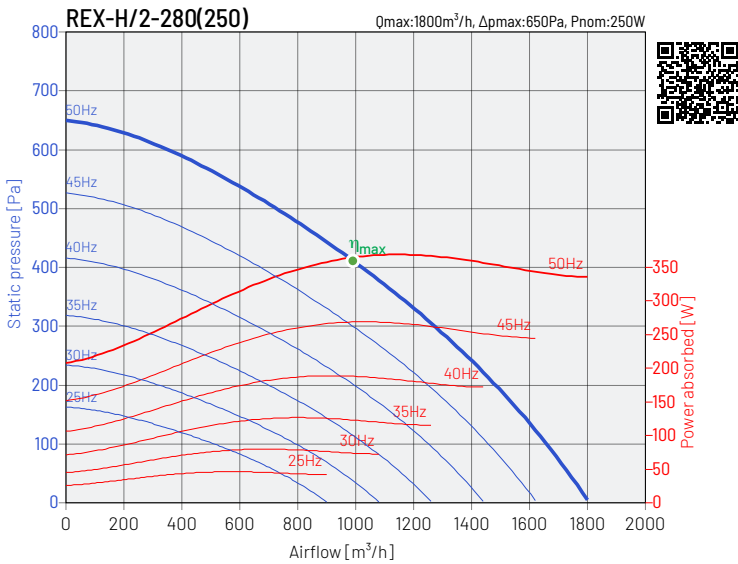
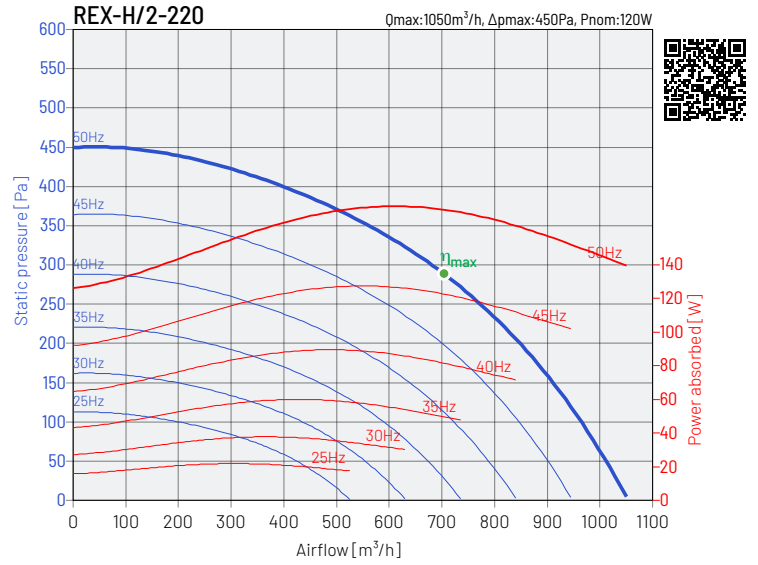
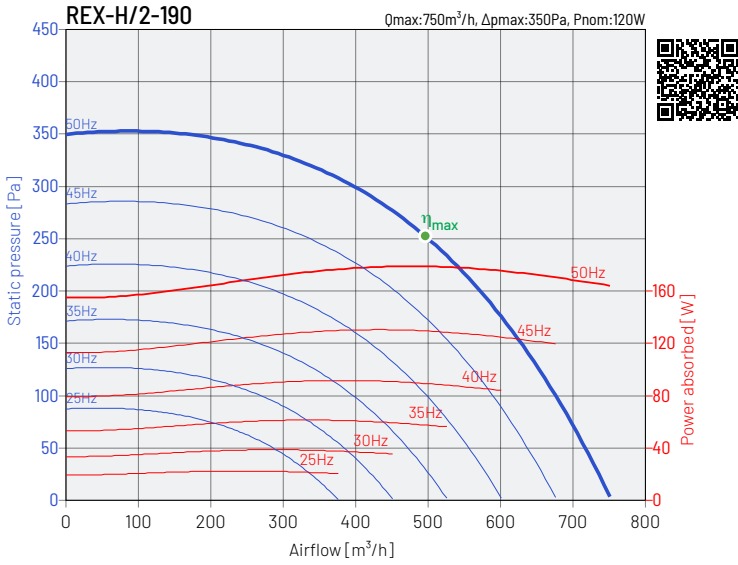

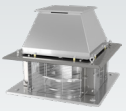

PERFORMANCE CHARACTERISTICS OF THE FANS

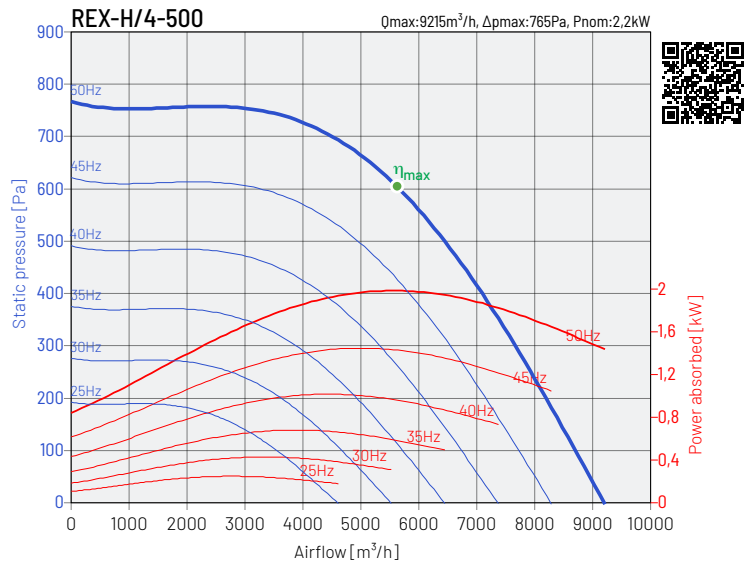
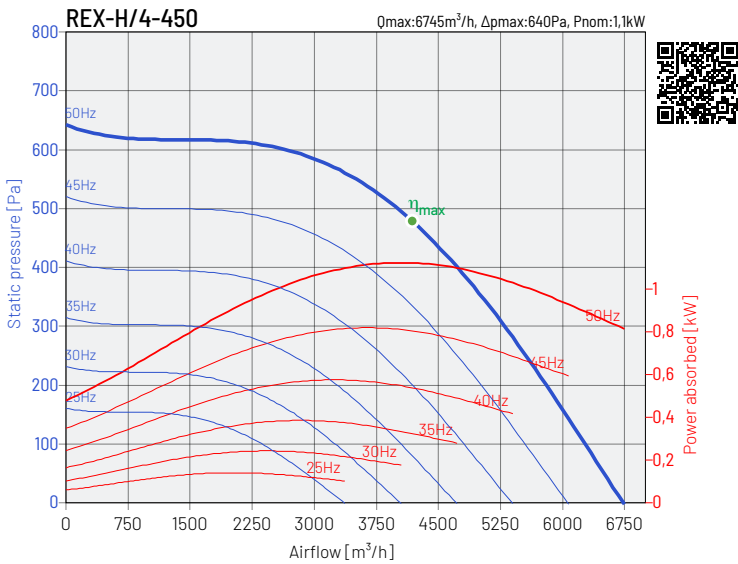
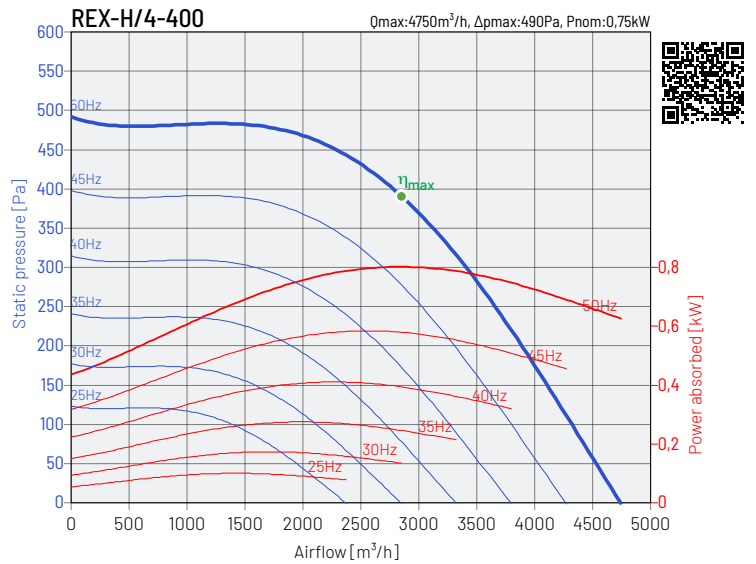
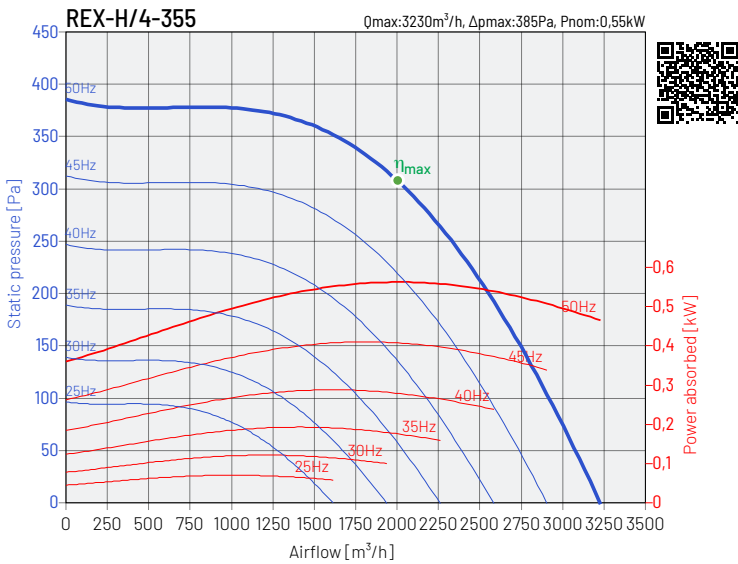
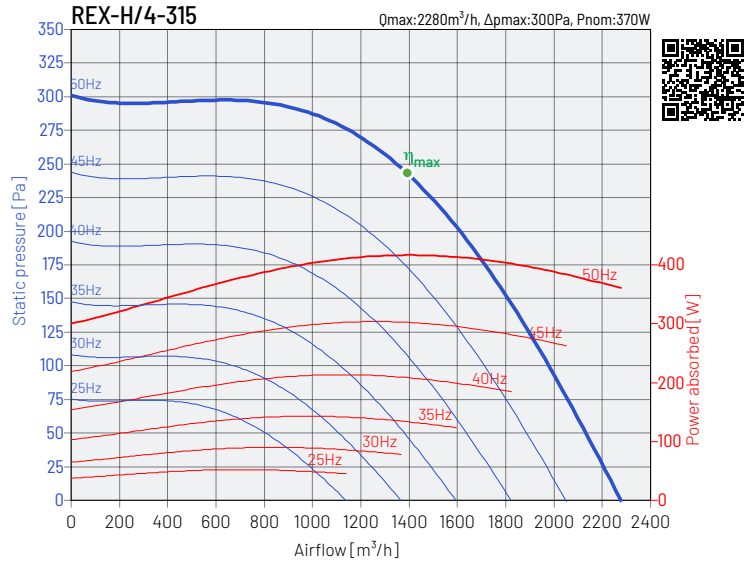
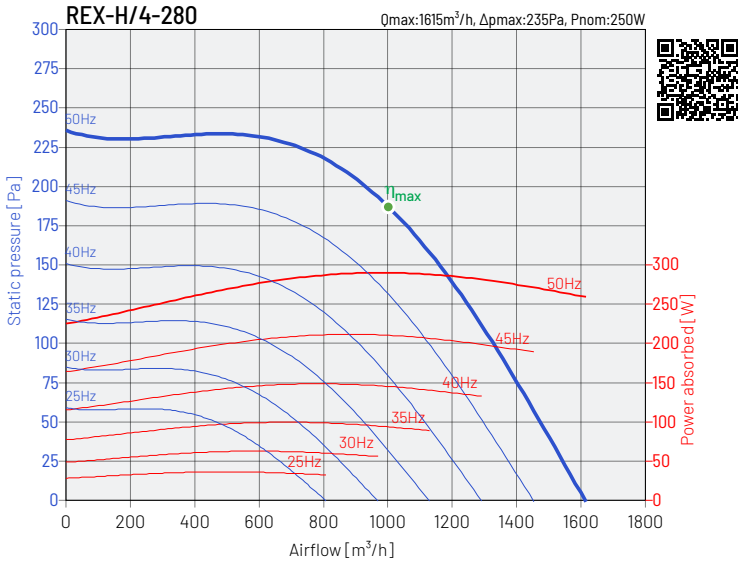

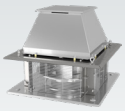

PERFORMANCE CHARACTERISTICS OF THE FANS

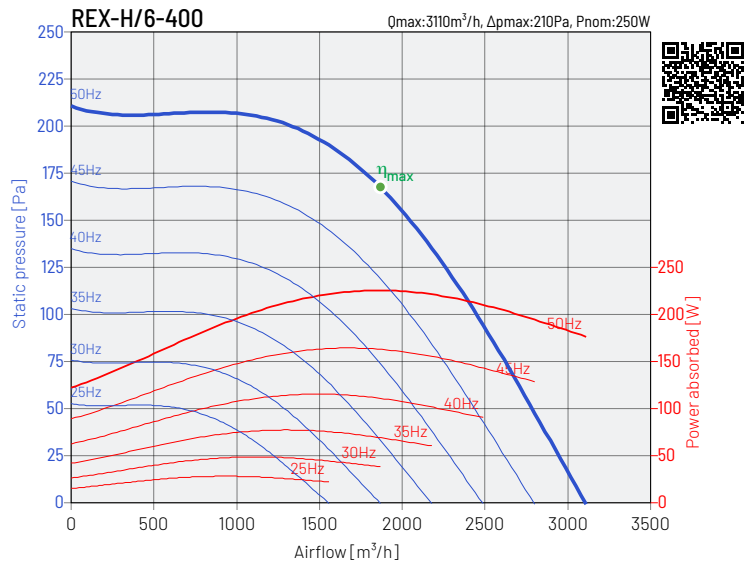
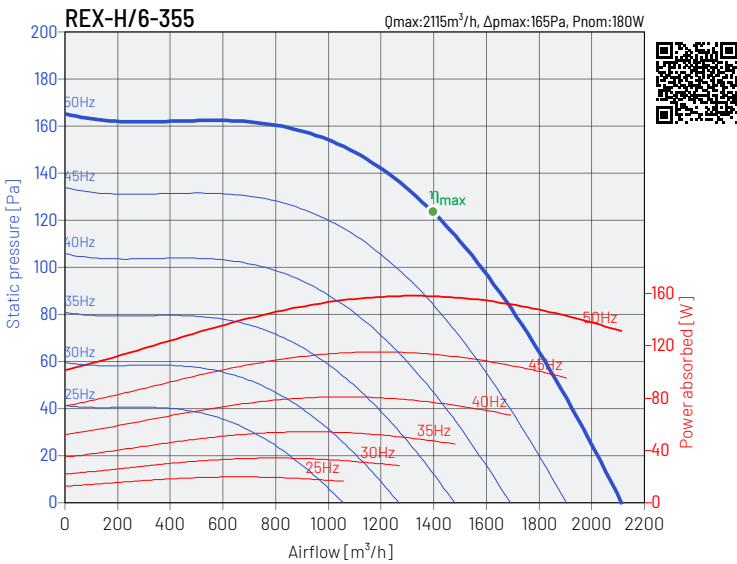
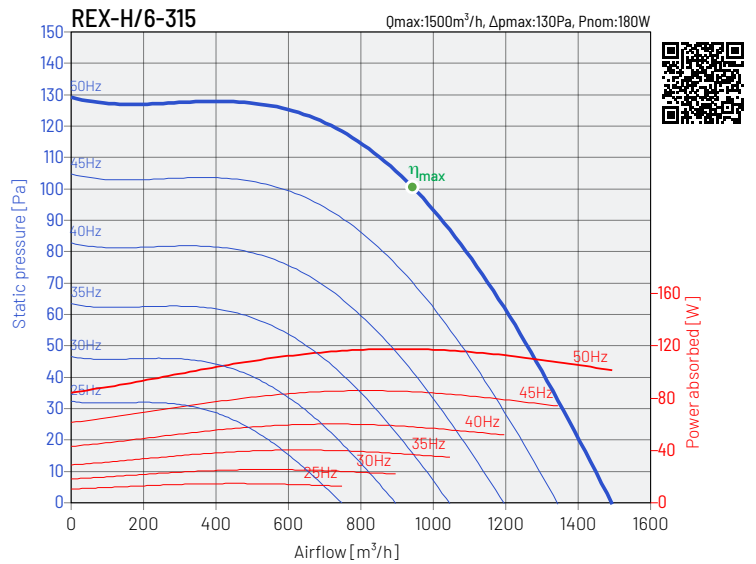
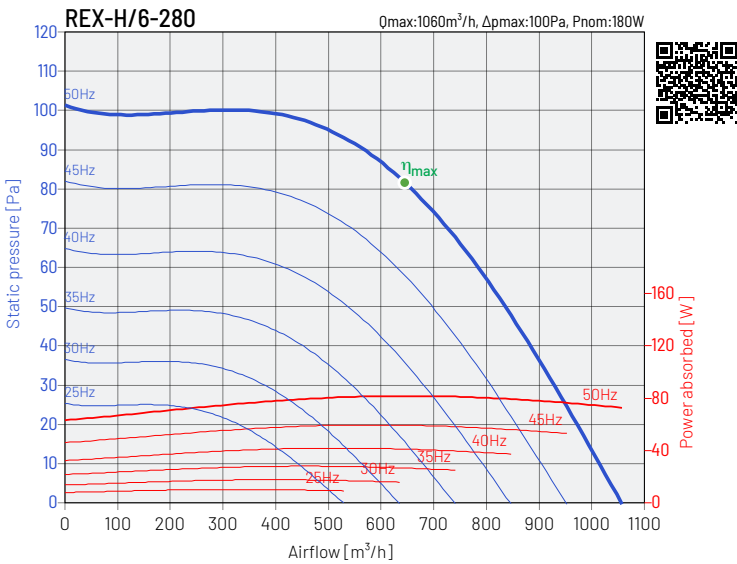
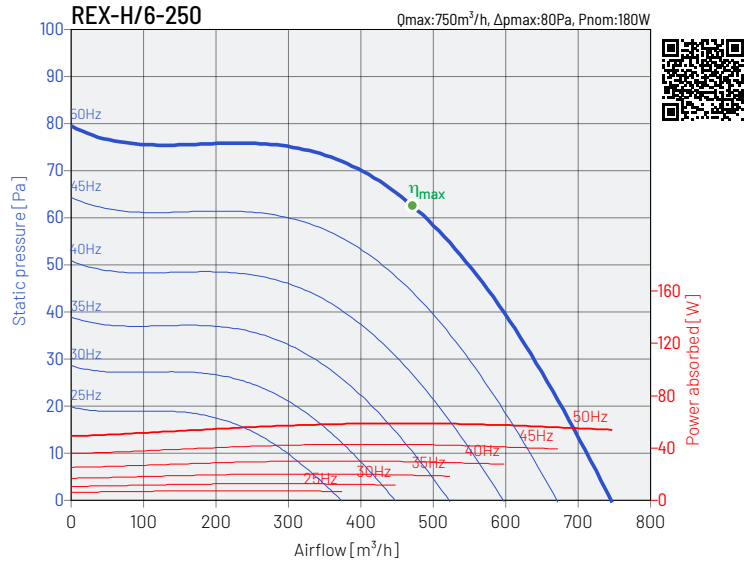
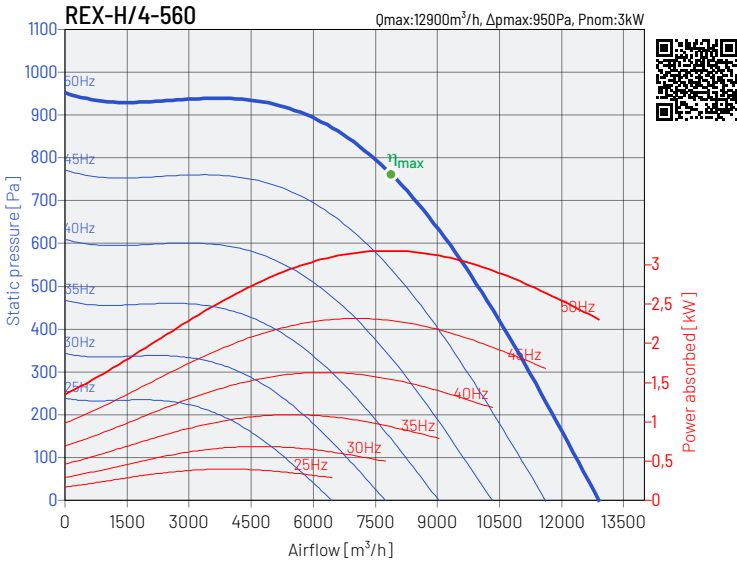

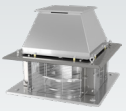

PERFORMANCE CHARACTERISTICS OF THE FANS

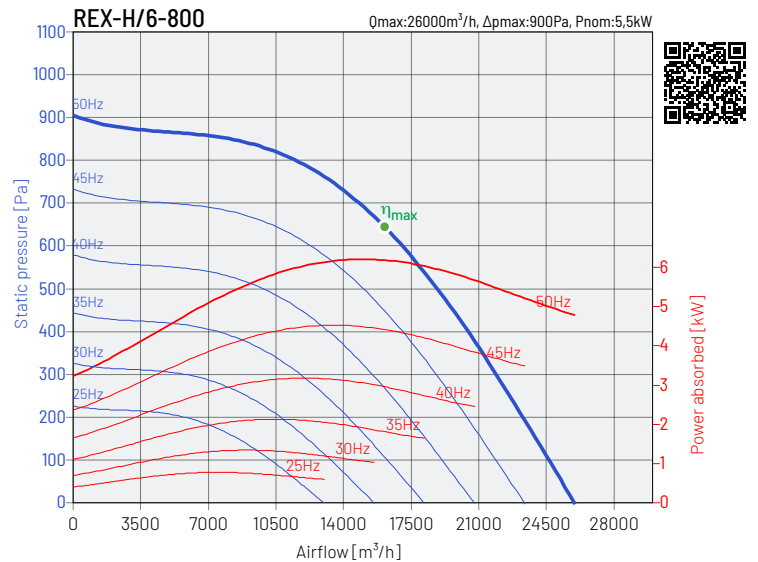
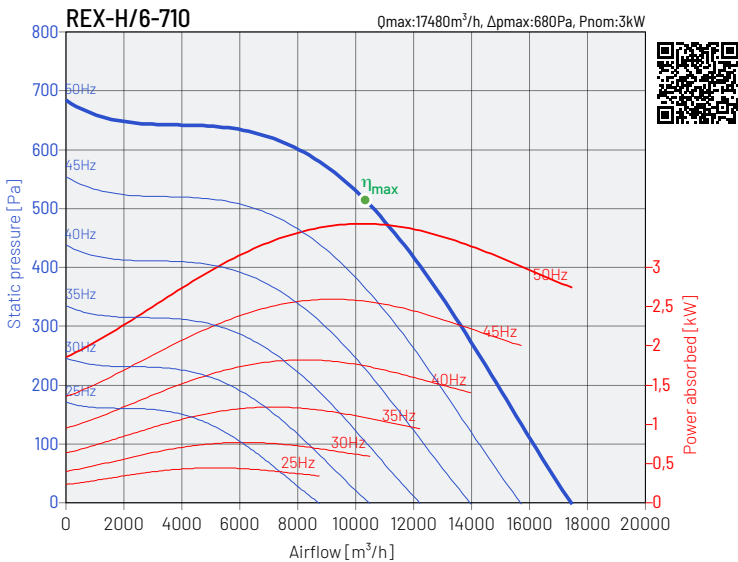
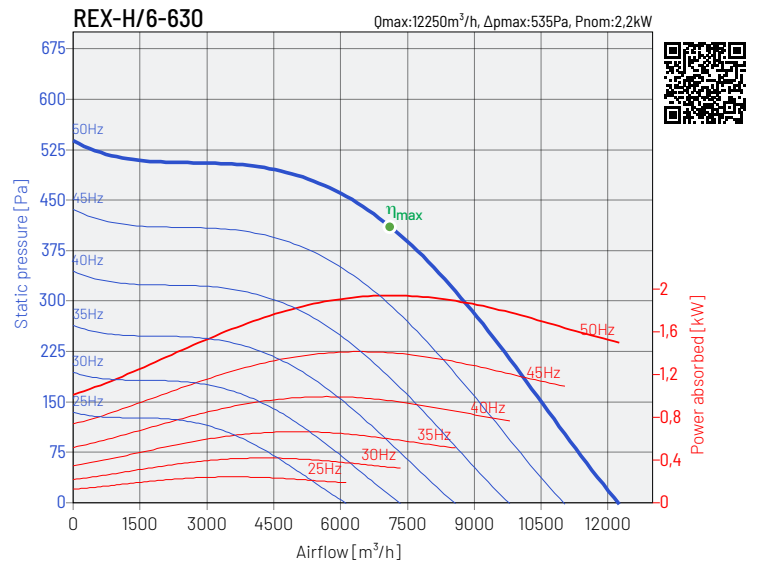
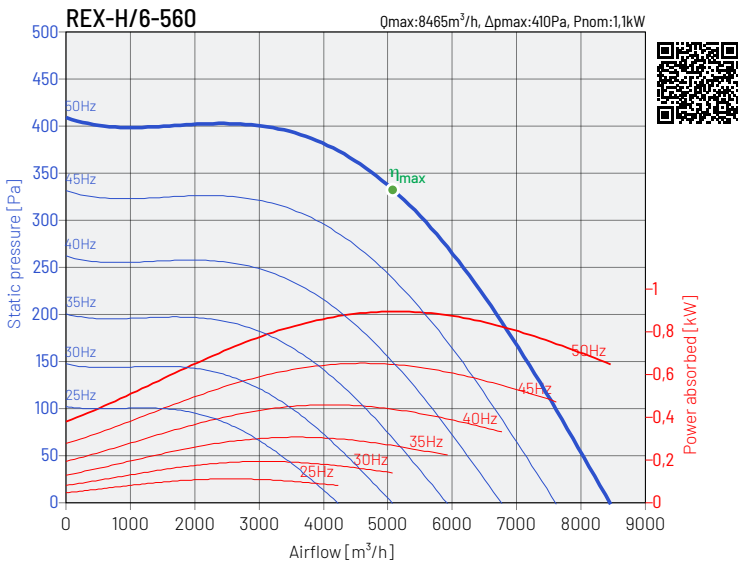
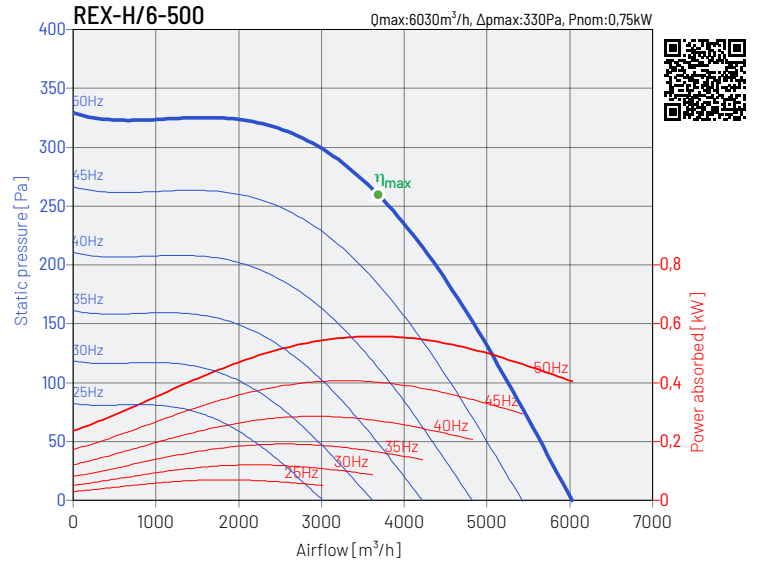
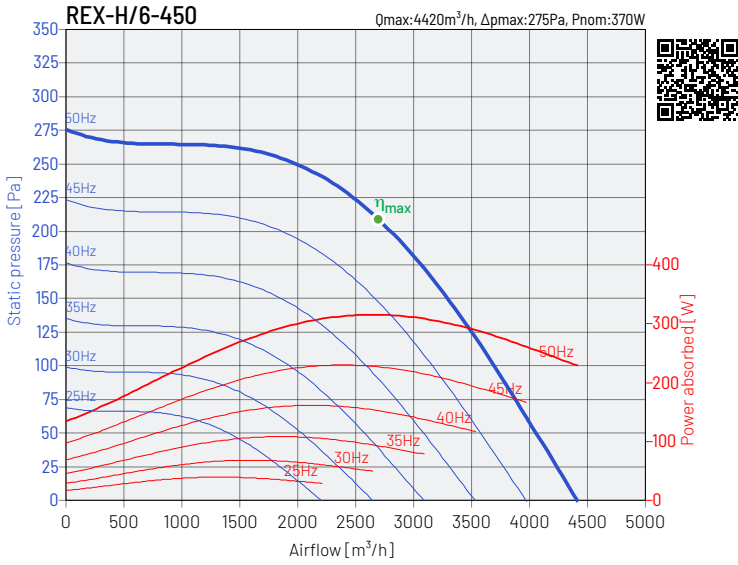

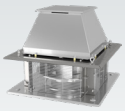

DIMENSIONS

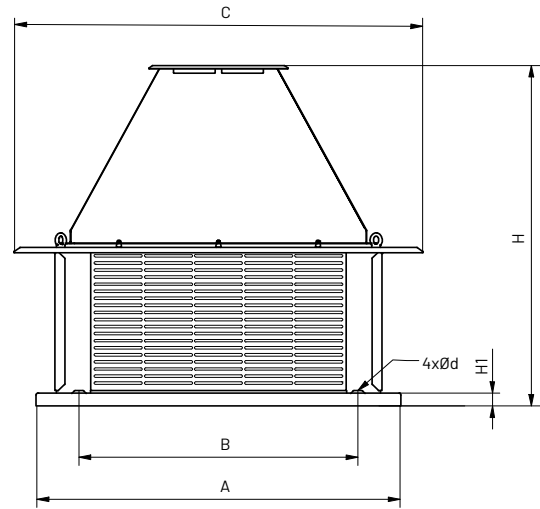
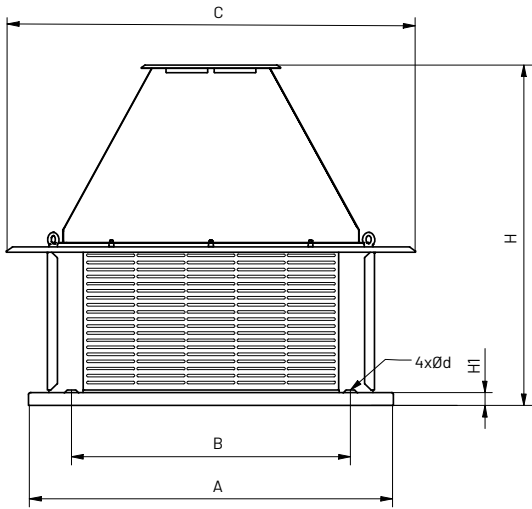

type	A mm	B mm	C mm	Ød mm	H mm	H1 mm
REX-x-190	435	330	386	12	385	15
REX-x-220	435	330	386	12	385	15
REX-x-250	435	330	441	12	453	15
REX-2-280	435	330	441	12	416	15
REX-4-280	435	330	441	12	453	15
REX-x-315	560	450	513	12	495	15
REX-x-355	560	450	583	12	540	15

type	A mm	B mm	C mm	Ød mm	H mm	H1 mm
REX-x-400	560	450	653	12	554	15
REX-x-450	710	590	731	12	603	15
REX-x-500	710	590	811	12	707	15
REX-x-560	710	590	896	12	781	15
REX-x-630	900	750	1001	14	797	40
REX-x-710	900	750	1121	14	885	40
REX-x-800	1100	840	1241	14	1060	40

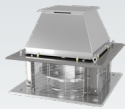

MOUNTING ACCESSORIES

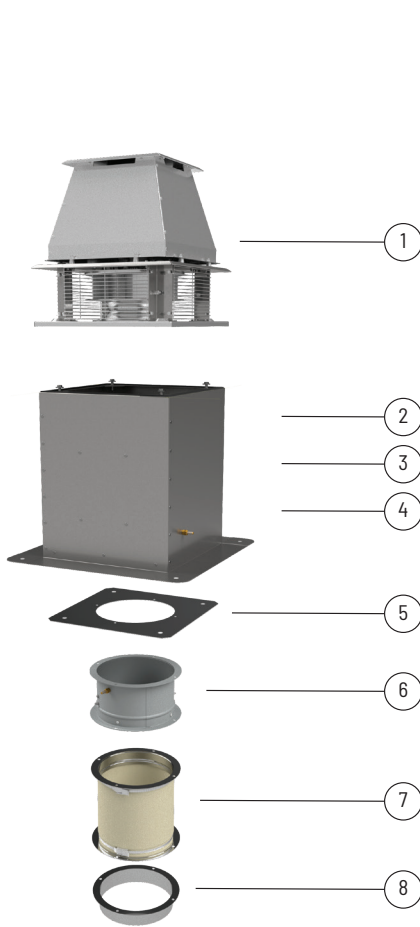

type	flat roof up RSS/EX	flat roof up RS/EX	flat roof up RSA/EX	mounting plate P/EX
REX-H/x-190	RSS/EX-435	RS/EX-435	RSA/EX-435	P/EX-435
REX-H/x-220	RSS/EX-435	RS/EX-435	RSA/EX-435	P/EX-435
REX-H/x-250	RSS/EX-435	RS/EX-435	RSA/EX-435	P/EX-435
REX-H/x-280	RSS/EX-435	RS/EX-435	RSA/EX-435	P/EX-435
REX-H/x-315	RSS/EX-560	RS/EX-560	RSA/EX-560	P/EX-560
REX-H/x-355	RSS/EX-560	RS/EX-560	RSA/EX-560	P/EX-560
REX-H/x-400	RSS/EX-560	RS/EX-560	RSA/EX-560	P/EX-560
REX-H/x-450	RSS/EX-710	RS/EX-710	RSA/EX-710	P/EX-710
REX-H/x-500	RSS/EX-710	RS/EX-710	RSA/EX-710	P/EX-710
REX-H/x-560	RSS/EX-710	RS/EX-710	RSA/EX-710	P/EX-710
REX-H/x-630	RSS/EX-900	RS/EX-900	RSA/EX-900	P/EX-900
REX-H/x-710	RSS/EX-900	RS/EX-900	RSA/EX-900	P/EX-900
REX-H/x-800	RSS/EX-1100	RS/EX-1100	RSA/EX-1100	P/EX-1100



type	backflow preventer KZD/EX	zconnector anti-vibration ZPDO/EX	stub pipe K/EX
REX-H/x-190	KZD/EX-435	ZPDO/EX-435	K/EX-435
REX-H/x-220	KZD/EX-435	ZPDO/EX-435	K/EX-435
REX-H/x-250	KZD/EX-435	ZPDO/EX-435	K/EX-435
REX-H/x-280	KZD/EX-435	ZPDO/EX-435	K/EX-435
REX-H/x-315	KZD/EX-560	ZPDO/EX-560	K/EX-560
REX-H/x-355	KZD/EX-560	ZPDO/EX-560	K/EX-560
REX-H/x-400	KZD/EX-560	ZPDO/EX-560	K/EX-560
REX-H/x-450	KZD/EX-710	ZPDO/EX-710	K/EX-710
REX-H/x-500	KZD/EX-710	ZPDO/EX-710	K/EX-710
REX-H/x-560	KZD/EX-710	ZPDO/EX-710	K/EX-710
REX-H/x-630	KZD/EX-900	ZPDO/EX-900	K/EX-900
REX-H/x-710	KZD/EX-900	ZPDO/EX-900	K/EX-900
REX-H/x-800	KZD/EX-1100	ZPDO/EX-1100	K/EX-1100

Article numbers

43527601	RSS/EX-435	43527621	RSA/EX-435	43527631	P/EX-435	43527641	KZD/EX-435	43527651	ZPDO/EX-435	43527661	K/EX-435
43527602	RSS/EX-560	43527622	RSA/EX-560	43527632	P/EX-560	43527642	KZD/EX-560	43527652	ZPDO/EX-560	43527662	K/EX-560
43527603	RSS/EX-710	43527623	RSA/EX-710	43527633	P/EX-710	43527643	KZD/EX-710	43527653	ZPDO/EX-710	43527663	K/EX-710
43527604	RSS/EX-900	43527624	RSA/EX-900	43527634	P/EX-900	43527644	KZD/EX-900	43527654	ZPDO/EX-900	43527664	K/EX-900
43527605	RSS/EX-1100	43527625	RSA/EX-1100	43527635	P/EX-1100	43527645	KZD/EX-1100	43527655	ZPDO/EX-1100	43527665	K/EX-1100
43527611	RS/EX-435										
43527612	RS/EX-560										
43527613	RS/EX-710										
43527614	RS/EX-900										
43527615	RS/EX-1100										

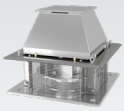

ELECTRICAL ACCESSORIES



type	inverter L	switch PTC	service switch	contactor
2-POLE MOTORS 3000RPM				
REX-H/2-190-012T 2G	-	U-EK230	R-S 3-F + SP, 16A	DILM7-10(230V50HZ)
REX-H/2-190-012T 2G VFD	L 0,4 kW	U-EK230	R-S 3-F + SP, 16A	DILM7-10(230V50HZ)
REX-H/2-190-012T 2GD VFD	L 0,4 kW	U-EK230	R-S 3-F + SP, 16A	DILM7-10(230V50HZ)
REX-H/2-190-012S 2G	-	U-EK230	R-S 1-F + SP, 16A	DILM7-10(230V50HZ)
REX-H/2-190-012S 2GD	-	U-EK230	R-S 1-F + SP, 16A	DILM7-10(230V50HZ)
REX-H/2-220-012T 2G	-	U-EK230	R-S 3-F + SP, 16A	DILM7-10(230V50HZ)
REX-H/2-220-012T 2G VFD	L 0,4 kW	U-EK230	R-S 3-F + SP, 16A	DILM7-10(230V50HZ)
REX-H/2-220-012T 2GD VFD	L 0,4 kW	U-EK230	R-S 3-F + SP, 16A	DILM7-10(230V50HZ)
REX-H/2-220-012S 2G	-	U-EK230	R-S 1-F + SP, 16A	DILM7-10(230V50HZ)
REX-H/2-220-012S 2GD	-	U-EK230	R-S 1-F + SP, 16A	DILM7-10(230V50HZ)
REX-H/2-280(250)-025T 2G	-	U-EK230	R-S 3-F + SP, 16A	DILM7-10(230V50HZ)
REX-H/2-280(250)-025T 2G VFD	L 0,4 kW	U-EK230	R-S 3-F + SP, 16A	DILM7-10(230V50HZ)
REX-H/2-280(250)-025T 2GD VFD	L 0,4 kW	U-EK230	R-S 3-F + SP, 16A	DILM7-10(230V50HZ)
REX-H/2-280(250)-025S 2G	-	U-EK230	R-S 1-F + SP, 16A	DILM7-10(230V50HZ)
REX-H/2-280(250)-025S 2GD	-	U-EK230	R-S 1-F + SP, 16A	DILM7-10(230V50HZ)
4-POLE MOTORS 1500RPM				
REX-H/4-190-006T 2G	-	U-EK230	R-S 3-F + SP, 16A	DILM7-10(230V50HZ)
REX-H/4-190-012T 2G VFD	L 0,4 kW	U-EK230	R-S 3-F + SP, 16A	DILM7-10(230V50HZ)
REX-H/4-190-012T 2GD VFD	L 0,4 kW	U-EK230	R-S 3-F + SP, 16A	DILM7-10(230V50HZ)
REX-H/4-190-009S 2G	-	U-EK230	R-S 1-F + SP, 16A	DILM7-10(230V50HZ)
REX-H/4-190-009S 2GD	-	U-EK230	R-S 1-F + SP, 16A	DILM7-10(230V50HZ)
REX-H/4-220-006T 2G	-	U-EK230	R-S 3-F + SP, 16A	DILM7-10(230V50HZ)
REX-H/4-220-012T 2G VFD	L 0,4 kW	U-EK230	R-S 3-F + SP, 16A	DILM7-10(230V50HZ)
REX-H/4-220-012T 2GD VFD	L 0,4 kW	U-EK230	R-S 3-F + SP, 16A	DILM7-10(230V50HZ)
REX-H/4-220-009S 2G	-	U-EK230	R-S 1-F + SP, 16A	DILM7-10(230V50HZ)
REX-H/4-220-009S 2GD	-	U-EK230	R-S 1-F + SP, 16A	DILM7-10(230V50HZ)
REX-H/4-250-018T 2G	-	U-EK230	R-S 3-F + SP, 16A	DILM7-10(230V50HZ)
REX-H/4-250-018T 2G VFD	L 0,4 kW	U-EK230	R-S 3-F + SP, 16A	DILM7-10(230V50HZ)
REX-H/4-250-018T 2GD VFD	L 0,4 kW	U-EK230	R-S 3-F + SP, 16A	DILM7-10(230V50HZ)
REX-H/4-250-018S 2G	-	U-EK230	R-S 1-F + SP, 16A	DILM7-10(230V50HZ)
REX-H/4-250-018S 2GD	-	U-EK230	R-S 1-F + SP, 16A	DILM7-10(230V50HZ)
REX-H/4-280-025T 2G	-	U-EK230	R-S 3-F + SP, 16A	DILM7-10(230V50HZ)
REX-H/4-280-025T 2G VFD	L 0,4 kW	U-EK230	R-S 3-F + SP, 16A	DILM7-10(230V50HZ)
REX-H/4-280-025T 2GD VFD	L 0,4 kW	U-EK230	R-S 3-F + SP, 16A	DILM7-10(230V50HZ)
REX-H/4-280-025S 2G	-	U-EK230	R-S 1-F + SP, 16A	DILM7-10(230V50HZ)
REX-H/4-280-025S 2GD	-	U-EK230	R-S 1-F + SP, 16A	DILM7-10(230V50HZ)
REX-H/4-315-037T 2G	-	U-EK230	R-S 3-F + SP, 16A	DILM7-10(230V50HZ)
REX-H/4-315-037T 2G VFD	L 0,4 kW	U-EK230	R-S 3-F + SP, 16A	DILM7-10(230V50HZ)
REX-H/4-315-037T 2GD VFD	L 0,4 kW	U-EK230	R-S 3-F + SP, 16A	DILM7-10(230V50HZ)
REX-H/4-315-037S 2G	-	U-EK230	R-S 1-F + SP, 16A	DILM7-10(230V50HZ)
REX-H/4-315-037S 2GD	-	U-EK230	R-S 1-F + SP, 16A	DILM7-10(230V50HZ)
REX-H/4-355-055T 2G	-	U-EK230	R-S 3-F + SP, 16A	DILM7-10(230V50HZ)
REX-H/4-355-055T 2G VFD	L 0,75 kW	U-EK230	R-S 3-F + SP, 16A	DILM7-10(230V50HZ)
REX-H/4-355-055T 2GD VFD	L 0,75 kW	U-EK230	R-S 3-F + SP, 16A	DILM7-10(230V50HZ)
REX-H/4-355-055S 2G	-	U-EK230	R-S 1-F + SP, 16A	DILM7-10(230V50HZ)
REX-H/4-355-055S 2GD	-	U-EK230	R-S 1-F + SP, 16A	DILM7-10(230V50HZ)
REX-H/4-400-075T 2G	-	U-EK230	R-S 3-F + SP, 16A	DILM7-10(230V50HZ)
REX-H/4-400-075T 2G VFD	L 0,75 kW	U-EK230	R-S 3-F + SP, 16A	DILM7-10(230V50HZ)
REX-H/4-400-075T 2GD VFD	L 0,75 kW	U-EK230	R-S 3-F + SP, 16A	DILM7-10(230V50HZ)

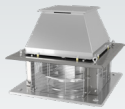

ELECTRICAL ACCESSORIES



type	inverter L	switch PTC	service switch	contactor
REX-H/4-400-075S 2G	-	U-EK230	R-S 1-F + SP, 16A	DILM7-10(230V50HZ)
REX-H/4-400-075S 2GD	-	U-EK230	R-S 1-F + SP, 16A	DILM7-10(230V50HZ)
REX-H/4-450-110T 2G	-	U-EK230	R-S 3-F + SP, 16A	DILM7-10(230V50HZ)
REX-H/4-450-110T 2G VFD	L 1,5 kW	U-EK230	R-S 3-F + SP, 16A	DILM7-10(230V50HZ)
REX-H/4-450-110T 2GD VFD	L 1,5 kW	U-EK230	R-S 3-F + SP, 16A	DILM7-10(230V50HZ)
REX-H/4-450-110S 2G	-	U-EK230	R-S 1-F + SP, 16A	DILM7-10(230V50HZ)
REX-H/4-450-110S 2GD	-	U-EK230	R-S 1-F + SP, 16A	DILM7-10(230V50HZ)
REX-H/4-500-220T 2G	-	U-EK230	R-S 3-F + SP, 16A	DILM7-10(230V50HZ)
REX-H/4-500-220T 2G VFD	L 2,2 kW	U-EK230	R-S 3-F + SP, 16A	DILM7-10(230V50HZ)
REX-H/4-500-220T 2GD VFD	L 2,2 kW	U-EK230	R-S 3-F + SP, 16A	DILM7-10(230V50HZ)
REX-H/4-560-300T 2G	-	U-EK230	R-S 3-F + SP, 16A	DILM7-10(230V50HZ)
REX-H/4-560-300T 2G VFD	L 3 kW	U-EK230	R-S 3-F + SP, 16A	DILM7-10(230V50HZ)
REX-H/4-560-300T 2GD VFD	L 3 kW	U-EK230	R-S 3-F + SP, 16A	DILM7-10(230V50HZ)
6-POLE MOTORS 1000RPM				
REX-H/6-250-018T 2G	-	U-EK230	R-S 3-F + SP, 16A	DILM7-10(230V50HZ)
REX-H/6-250-012T 2G VFD	L 0,4 kW	U-EK230	R-S 3-F + SP, 16A	DILM7-10(230V50HZ)
REX-H/6-250-012T 2GD VFD	L 0,4 kW	U-EK230	R-S 3-F + SP, 16A	DILM7-10(230V50HZ)
REX-H/6-280-018T 2G	-	U-EK230	R-S 3-F + SP, 16A	DILM7-10(230V50HZ)
REX-H/6-280-012T 2G VFD	L 0,4 kW	U-EK230	R-S 3-F + SP, 16A	DILM7-10(230V50HZ)
REX-H/6-280-012T 2GD VFD	L 0,4 kW	U-EK230	R-S 3-F + SP, 16A	DILM7-10(230V50HZ)
REX-H/6-315-018T 2G	-	U-EK230	R-S 3-F + SP, 16A	DILM7-10(230V50HZ)
REX-H/6-315-012T 2G VFD	L 0,4 kW	U-EK230	R-S 3-F + SP, 16A	DILM7-10(230V50HZ)
REX-H/6-315-012T 2GD VFD	L 0,4 kW	U-EK230	R-S 3-F + SP, 16A	DILM7-10(230V50HZ)
REX-H/6-355-018T 2G	-	U-EK230	R-S 3-F + SP, 16A	DILM7-10(230V50HZ)
REX-H/6-355-018T 2G VFD	L 0,4 kW	U-EK230	R-S 3-F + SP, 16A	DILM7-10(230V50HZ)
REX-H/6-355-018T 2GD VFD	L 0,4 kW	U-EK230	R-S 3-F + SP, 16A	DILM7-10(230V50HZ)
REX-H/6-400-025T 2G	-	U-EK230	R-S 3-F + SP, 16A	DILM7-10(230V50HZ)
REX-H/6-400-025T 2G VFD	L 0,4 kW	U-EK230	R-S 3-F + SP, 16A	DILM7-10(230V50HZ)
REX-H/6-400-025T 2GD VFD	L 0,4 kW	U-EK230	R-S 3-F + SP, 16A	DILM7-10(230V50HZ)
REX-H/6-450-037T 2G	-	U-EK230	R-S 3-F + SP, 16A	DILM7-10(230V50HZ)
REX-H/6-450-037T 2G VFD	L 0,4 kW	U-EK230	R-S 3-F + SP, 16A	DILM7-10(230V50HZ)
REX-H/6-450-037T 2GD VFD	L 0,4 kW	U-EK230	R-S 3-F + SP, 16A	DILM7-10(230V50HZ)
REX-H/6-500-075T 2G	-	U-EK230	R-S 3-F + SP, 16A	DILM7-10(230V50HZ)
REX-H/6-500-075T 2G VFD	L 0,75 kW	U-EK230	R-S 3-F + SP, 16A	DILM7-10(230V50HZ)
REX-H/6-500-075T 2GD VFD	L 0,75 kW	U-EK230	R-S 3-F + SP, 16A	DILM7-10(230V50HZ)
REX-H/6-560-110T 2G	-	U-EK230	R-S 3-F + SP, 16A	DILM7-10(230V50HZ)
REX-H/6-560-110T 2G VFD	L 1,5 kW	U-EK230	R-S 3-F + SP, 16A	DILM7-10(230V50HZ)
REX-H/6-560-110T 2GD VFD	L 1,5 kW	U-EK230	R-S 3-F + SP, 16A	DILM7-10(230V50HZ)
REX-H/6-630-220T 2G	-	U-EK230	R-S 3-F + SP, 16A	DILM7-10(230V50HZ)
REX-H/6-630-220T 2G VFD	L 2,2 kW	U-EK230	R-S 3-F + SP, 16A	DILM7-10(230V50HZ)
REX-H/6-630-220T 2GD VFD	L 2,2 kW	U-EK230	R-S 3-F + SP, 16A	DILM7-10(230V50HZ)
REX-H/6-710-300T 2G	-	U-EK230	R-S 3-F + SP, 16A	DILM7-10(230V50HZ)
REX-H/6-710-300T 2G VFD	L 4,0 kW	U-EK230	R-S 3-F + SP, 16A	DILM7-10(230V50HZ)
REX-H/6-710-300T 2GD VFD	L 4,0 kW	U-EK230	R-S 3-F + SP, 16A	DILM7-10(230V50HZ)
REX-H/6-800-550T 2G	-	U-EK230	R-S 3-F + SP, 25A/6	DILM12-10(230V50HZ)
REX-H/6-800-550T 2G VFD	L 5,5 kW	U-EK230	R-S 3-F + SP, 25A	DILM12-10(230V50HZ)
REX-H/6-800-550T 2GD VFD	L 5,5 kW	U-EK230	R-S 3-F + SP, 25A	DILM12-10(230V50HZ)

* equipment for the safe zone, execution for the ATEX zone consult with the Technical Department of Venture Industries Sp. z o.o.